

NOT MEASUREMENT
SENSITIVE

MIL-STD-1388-2B
28 MARCH 1991
NOTICE 1
21 JANUARY 93

SUPERSEDING
MIL-STD1388-2A
10 JULY 84

MILITARY STANDARD

DOD REQUIREMENTS FOR A LOGISTIC SUPPORT ANALYSIS RECORD



AMSC NO. A6045

FCS ILSS

DISTRIBUTION STATEMENT A. Approved for public release; distribution is unlimited.

MILITARY STANDARD

MIL-STD-1388-2B
 Notice 1
 21 Jan 93

DOD REQUIREMENTS FOR A LOGISTIC SUPPORT ANALYSIS RECORD
 TO ALL HOLDERS OF MIL-STD-1388-2B

1. THE FOLLOWING PAGES OF MIL-STD-1388-2B HAVE BEEN REVISED AND SUPERSEDE THE PAGES LISTED:

NEW PAGE(S)	DATE	SUPERSEDED PAGE(S)	DATE
v	28 March 1991	v	REPRINTED WITHOUT CHANGE
vi and vii	21 January 1993	vi and vii	28 March 1991
viii	28 March 1991	viii	REPRINTED WITHOUT CHANGE
ix/x	21 January 1993	ix/x	28 March 1991
7 and 8	21 January 1993	7 and 8	28 March 1991
9	28 March 1991	9	REPRINTED WITHOUT CHANGE
10 thru 14	21 January 1993	10 thru 14	28 March 1991
17	28 March 1991	17	REPRINTED WITHOUT CHANGE
18 and 19/20	21 January 1993	18 and 19/20	28 March 1991
23 and 24	21 January 1993	23 and 24	28 March 1991
25	28 March 1991	25	REPRINTED WITHOUT CHANGE
26	21 January 1993	26	28 March 1991
29	21 January 1993	29	28 March 1991
30	28 March 1991	30	REPRINTED WITHOUT CHANGE
37	28 March 1991	37	REPRINTED WITHOUT CHANGE
38 and 39	21 January 1993	38 and 39	28 March 1991
40 and 41	28 March 1991	40 and 41	REPRINTED WITHOUT CHANGE
42	21 January 1993	42	28 March 1991
43	28 March 1991	43	REPRINTED WITHOUT CHANGE
44	21 January 1993	44	28 March 1991
55 and 56	21 January 1993	55 and 56	28 March 1991
59 thru 61	21 January 1993	59 thru 61	28 March 1991
62 and 63	28 March 1991	62 and 63	REPRINTED WITHOUT CHANGE
64 thru 66	21 January 1993	64 thru 66	28 March 1991
71	28 March 1991	71	REPRINTED WITHOUT CHANGE
72	21 January 1993	72	28 March 1991
75 thru 77	21 January 1993	75 thru 77	28 March 1991
78	28 March 1991	78	REPRINTED WITHOUT CHANGE
79 thru 81	21 January 1993	79 thru 81	28 March 1991
82	28 March 1991	82	REPRINTED WITHOUT CHANGE
95	21 January 1993	95	28 March 1991
95a	21 January 1993	NEW	
96	21 January 1993	96	28 March 1991
99 and 100	21 January 1993	99 and 100	28 March 1991
102	21 January 1993	102	28 March 1991
103	28 March 1991	103	REPRINTED WITHOUT CHANGE
107	28 March 1991	107	REPRINTED WITHOUT CHANGE
108 thru 110	21 January 1993	108 thru 110	28 March 1991

AMSC NO A6045

FSC ILSS

DISTRIBUTION STATEMENT A. Approved for public release: distribution is unlimited.

MILITARY STANDARD

129	21 January 1993	129	28 March 1991
130 and 131	28 March 1991	130 and 131	REPRINTED WITHOUT CHANGE
132 and 133	21 January 1993	132 and 133	28 March 1991
134	28 March 1991	134	REPRINTED WITHOUT CHANGE
135	21 January 1993	135	28 March 1991
136	28 March 1991	136	REPRINTED WITHOUT CHANGE
137	21 January 1993	137	28 March 1991
138	28 March 1991	138	REPRINTED WITHOUT CHANGE
139	21 January 1993	139	28 March 1991
140	28 March 1991	140	REPRINTED WITHOUT CHANGE
143	21 January 1993	143	28 March 1991
144	28 March 1991	144	REPRINTED WITHOUT CHANGE
149	21 January 1993	149	28 March 1991
150 thru 155	21 January 1993	150 thru 155	28 March 1991
156	28 March 1991	156	REPRINTED WITHOUT CHANGE
159 thru 162	21 January 1993	159 thru 162	28 March 1991
163	28 March 1991	163	REPRINTED WITHOUT CHANGE
164 thru 168	21 January 1993	164 thru 168	28 March 1991
173	28 March 1991	173	REPRINTED WITHOUT CHANGE
174 and 175	21 January 1993	174 and 175	28 March 1991
176	28 March 1991	176	REPRINTED WITHOUT CHANGE
177	21 January 1993	177	28 March 1991
178 and 179	28 March 1991	178 and 179	REPRINTED WITHOUT CHANGE
180 thru 186	21 January 1993	180 thru 186	28 March 1991
187	28 March 1991	187	REPRINTED WITHOUT CHANGE
188	21 January 1993	188	28 March 1991
193	28 March 1991	193	REPRINTED WITHOUT CHANGE
194	21 January 1993	194	28 March 1991
219	28 March 1991	219	REPRINTED WITHOUT CHANGE
220 thru 225	21 January 1993	220 thru 225	28 March 1991
226 and 227	28 March 1991	226 and 227	REPRINTED WITHOUT CHANGE
228	21 January 1993	228	28 March 1991
251	28 March 1991	251	REPRINTED WITHOUT CHANGE
252	21 January 1993	252	28 March 1991
255	28 March 1991	255	REPRINTED WITHOUT CHANGE
256	21 January 1993	256	28 March 1991
257	28 March 1991	257	REPRINTED WITHOUT CHANGE
258	21 January 1993	258	28 March 1991
261	28 March 1991	261	REPRINTED WITHOUT CHANGE
262	21 January 1993	262	28 March 1991
271	28 March 1991	271	REPRINTED WITHOUT CHANGE
272	21 January 1993	272	28 March 1991
273 thru 275	21 January 1993	273 thru 275	28 March 1991
276	28 March 1991	276	REPRINTED WITHOUT CHANGE
281	21 January 1993	281	28 March 1991
282	28 March 1991	282	REPRINTED WITHOUT CHANGE
303	28 March 1991	303	REPRINTED WITHOUT CHANGE
304	21 January 1993	304	28 March 1991
319	28 March 1991	319	REPRINTED WITHOUT CHANGE
320	21 January 1993	320	28 March 1991
335	21 January 1993	335	28 March 1991
336 and 337	28 March 1991	336 and 337	REPRINTED WITHOUT CHANGE
338 thru 340	21 January 1993	338 thru 340	28 March 1991

MILITARY STANDARD

341	28 March 1991	341	REPRINTED WITHOUT CHANGE
342 thru 353	21 January 1993	342 thru 353	28 March 1991
354 and 355	28 March 1991	354 and 355	REPRINTED WITHOUT CHANGE
356	21 January 1993	356	28 March 1991
387	28 March 1991	387	REPRINTED WITHOUT CHANGE
388 thru 401	21 January 1993	388 thru 401	28 March 1991
401a thru 401e	21 January 1993	NEW	
402	28 March 1991	402	REPRINTED WITHOUT CHANGE
419	28 March 1991	419	REPRINTED WITHOUT CHANGE
420	21 January 1993	420	28 March 1991
439	21 January 1993	439	28 March 1991
440	28 March 1991	440	REPRINTED WITHOUT CHANGE
445 and 446	21 January 1993	445 and 446	28 March 1991
451	21 January 1993	451	28 March 1991
452	28 March 1991	452	REPRINTED WITHOUT CHANGE
471	28 March 1991	471	REPRINTED WITHOUT CHANGE
472	21 January 1993	472	28 March 1991
483	28 March 1991	483	REPRINTED WITHOUT CHANGE
484	21 January 1993	484	28 March 1991
485	28 March 1991	485	REPRINTED WITHOUT CHANGE
486	21 January 1993	486	28 March 1991
491	28 March 1991	491	REPRINTED WITHOUT CHANGE
492	21 January 1993	492	28 March 1991
513	21 January 1993	513	28 March 1991
513a thru 513f	21 January 1993	NEW	
514	28 March 1991	514	REPRINTED WITHOUT CHANGE
515	21 January 1993	515	28 March 1991
516	28 March 1991	516	REPRINTED WITHOUT CHANGE
529	28 March 1991	529	REPRINTED WITHOUT CHANGE
530 and 531	21 January 1993	530 and 531	28 March 1991
532	28 March 1991	532	REPRINTED WITHOUT CHANGE
557	21 January 1993	557	28 March 1991
558	28 March 1991	558	REPRINTED WITHOUT CHANGE
571 thru 599/600	21 January 1993	571 thru 599/600	28 March 1991

2. RETAIN THIS NOTICE AND INSERT BEFORE TABLE OF CONTENTS.

3. Holders of MIL-STD-1388-2B will verify that the page change indicated herein have been entered. This notice will be retained as a check sheet. This issuance is a separate publication. Each notice is to be retained by stocking points until the Military Standard is completely revised or cancelled.

Custodians:

Army - TM
Navy - AS
Air Force - 95

Preparing Activity

Army - TM

(Project No. ILSS-0003)

Reviewing Activities:

Army - ME, MI, AV, AT, CR
Navy - SH, YD, OS, MC
Air Force - 11, 13, 15, 16, 17
Miscellaneous DOD/NASA - NS, NA, DC, DH, DS

FOREWORD

1. This military standard is approved for use by all departments and agencies of the Department of Defense (DOD).

2. Beneficial comments (recommendations, additions, deletions) and any pertinent data which may be of use in improving this document should be addressed to:

a. Director, OASD(P&L) Weapon Support Improvement Group
Room 2B322
Pentagon
Washington, DC

Telephone: (513) 255-3754

b. USAMC Materiel Readiness Support Activity
ATTN: AMXMD-EL
Lexington, KY 40511-5101

Telephone: (606) 293-3962

3. Each DOD service maintains a Logistic Support Analysis (LSA) support office. In order to ensure that a service-wide position is presented to the proponent office, comments originating with a particular DOD service should be forwarded through that service's LSA support office as listed below:

a. Air Force:

ALD/LSA
Wright-Patterson AFB, OH 45433

Telephone: (606) 293-3962

b. Army:

Commander, USAMC Materiel Readiness Support Activity
ATTN: AMXMD-EL
Lexington, KY 40511-5101

Telephone: (606) 293-3964

c. Marine Corps:

Commanding General, Marine Corps Research, Development and
Acquisition Command

ATTN: PSL-S
Washington, DC 20380-0001

Telephone: (703) 696-1180

d. Navy:

Commander, Naval Air Systems Command
ATTN: NAVAIR 41112
Washington, DC 20361

Telephone: (703) 692-0028

4. Comments may be submitted using the self-addressed Standardization Document Improvement Proposals (DD Form 1426) appearing at the end of this document, or by letter.

5. This standard is based on the joint efforts of the military services and the Federal Aviation Administration with assistance from private industry. The goal of this standard is to establish uniform requirements for development and delivery of LSA Record (LSAR) data. The LSA documentation, including LSAR data, is generated as a result of performing any of all of the analyses specified in MIL-STD-1388-1, Logistic Support Analysis (LSA). The requirements of this standard are applicable to major and less than major system/equipment acquisition programs, major modification programs, and applicable research and development projects.

6. The LSAR, as designed herein, is intentionally structured to accommodate the maximum range of data potentially required by all services and all Integrated Logistic Support (ILS) element functional areas. This approach permits standardization of field lengths and Data Element Definitions (DED), and establishes "one face to industry" for government required LSAR data. However, LSA documentation must be tailored to each acquisition program and life cycle phase. The tailoring of LSAR data should be consistent with the level and depth of LSA performed In Accordance With (IAW) MIL-STD-1388-1 as required to readiness and affordability of the acquisition program IAW Department of DOD Directive (DODD) 5000.39. An application guidance appendix (appendix D) is included herein to provide guidance on tailoring of LSAR data requirements to meet individual program objectives in a cost-effective manner. The general requirements of this standard also require completion of LSAR data selection sheets (DD Form 1949-1) to identify specific data for each program in order to prevent indiscriminate blanket applications of the data requirements.

7. This standard is directed toward improving the cost-effectiveness of the generation, maintenance, acquisition, and use of the technical data required to support an ILS program. This is accomplished through the following:

a. Standardization of LSAR DEDs, field lengths, and formats between the services and industry.

b. Consolidation of logistics oriented technical information for the various engineering disciplines and ILS elements into one file to reduce redundancy, facilitate timely usage, and enhance consistency between elements and disciplines.

c. Maximum use of industry-developed integrated data systems tied to engineering, manufacturing, and product support databases as sources of LSA documentation.

d. Requiring delivery of LSAR data in a format which promotes/ accommodates current database technology.

8. The LSAR documents data across all ILS functional areas. This characteristic makes the LSAR an ideal vehicle for integration of systems' engineering design, manufacturing, and product support databases for life cycle management of a system. The relational design of LSAR data is intended to facilitate such integration and to encourage independent development of useful ad hoc queries which promote use of the data in the design process. The use of industry-developed, cost-effective automation tools which link "islands of automation" (e.g., computerized drawings and technical manual authoring systems) through the LSAR is encouraged.

9. This standard allows for delivery of LSAR data in manual or automated mode, and online access to LSAR data, as specified by the requiring authority. It does not prescribe Automated Data Processing (ADP) software that must be used to process LSAR data. The minimum ADP design requirements that must be adhered to for industry-developed LSAR ADP systems are described under General Requirements, paragraph 4.2.2.1. These requirements are the basis for validation by government of industry-developed LSAR ADP systems.

10. Conversion of existing programs to MIL-STD-1388-2B data table format is encouraged. In order to assist in this effort, the Materiel Readiness Support Activity will provide, on request, software to convert MIL-STD-1388-2A master files to MIL-STD-1388-2B data table format.

CONTENTS

Paragraph		Page
1.	SCOPE	1
1.1	Purpose	1
1.2	Application of standard	1
1.2.1	Content of appendices	1
1.2.2	Tailoring	1
1.2.3	LSA data documentation process	1
2.	REFERENCED DOCUMENTS	6
2.1	General	6
3.	DEFINITIONS	9
4.	GENERAL REQUIREMENTS	10
4.1	LSAR data selection sheets	11
4.2	LSAR data	11
4.2.1	Manual LSAR data	12
4.2.1.1	Manual LSAR report generation	12
4.2.2	Automated LSAR data	12
4.2.2.1	Performing activity LSAR ADP system	12
4.2.2.2	LSAR ADP system criteria	12
5.	DETAILED INSTRUCTIONS FOR MANUAL/AUTOMATED PREPARATION OF LSAR RELATIONAL TABLES	13
5.1	Requiring authority data tables	13
5.1.1	Cross functional requirement	13
5.1.2	Operations and maintenance requirements	13
5.2	Performing activity data tables	13
5.2.1	Reliability, availability, maintainability; Failure modes, effects and criticality analysis; maintainability analysis	14
5.2.2	Task analysis and personnel and support requirements	14
5.2.3	Support equipment and training material requirements	15
5.2.4	Unit under test requirements and justification ..	15
5.2.5	Facilities considerations	15
5.2.6	Personnel skill considerations	15
5.2.7	Packaging and provisioning requirement	16
5.2.8	Transportability engineering analysis	16
5.3	LCN assignment and structure	16
5.4	LSA/LSAR guidance conference	16
6.	NOTES	17
6.1	Intended use	17
6.2	Issue of DODISS	17
6.3	Consideration of data requirements	17
6.4	Subject term (key word) listing	19
6.5	Suppression data	19
6.6	Changes from previous issue	19

APPENDICES

APPENDIX A.	LSAR RELATIONAL TABLES	21
10.	SCOPE	21
20.	CONCEPT	21
30.	RELATIONAL DATA TABLE FORMAT	21
30.1	Functional LSAR relational table listing and table relationships	21
30.2	LSAR relational tables	22
30.3	LSAR Data Table Exchange/Delivery	24
40.	CROSS FUNCTIONAL REQUIREMENT	26
50.	OPERATIONS AND MAINTENANCE REQUIREMENT	32
60.	RELIABILITY, AVAILABILITY, AND MAINTAINABILITY; FAILURE MODES, EFFECTS, AND CRITICALITY ANALYSIS; AND MAINTAINABILITY ANALYSIS	40
70.	TASK ANALYSIS AND PERSONNEL AND SUPPORT REQUIREMENTS	53
80.	SUPPORT EQUIPMENT AND TRAINING MATERIEL REQUIREMENTS	62
90.	UNIT UNDER TEST REQUIREMENTS AND DESCRIPTION	72
100.	FACILITIES CONSIDERATIONS	81
110	PERSONNEL SKILL CONSIDERATIONS	86
120	PACKAGING AND PROVISIONING REQUIREMENT	90
130	TRANSPORTABILITY ENGINEERING ANALYSIS	105
APPENDIX B.	LSAR REPORTS	115
10.	PURPOSE	115
20.	CONCEPT	115
20.1	LSAR data table to report matrix	115
20.2	General report selection criteria	115
30.	LSAR REPORTS	116
30.1	LSA-001, Annual Man-Hours by Skill Specialty Code and Level of Maintenance	116
30.2	LSA-003, Maintenance Summary	117
30.3	LSA-004, Maintenance Allocation Chart	118
30.4	LSA-005, Support Items Utilization Summary	120
30.5	LSA-006, Critical Maintenance Task Summary	121
30.6	LSA-007, Support Equipment Requirements	121
30.7	LSA-008, Support Items Validation Summary	121
30.8	LSA-009, Support Items List	122
30.9	LSA-010, Parts Standardization Summary	122
30.10	LSA-011, Special Training Equipment/Device Summary	122
30.11	LSA-012, Facility Requirement	122
30.12	LSA-013, Support Equipment Grouping Number Utilization Summary	123
30.13	LSA-014, Training Task List	123
30.14	LSA-016, Preliminary Maintenance Allocation Chart	123
30.15	LSA-018, Task Inventory Report	124
30.16	LSA-019, Task Analysis Summary	124
30.17	LSA-023, Maintenance Plan Summary	125
30.18	LSA-024, Maintenance Plan	126
30.19	LSA-025, Packaging Requirements Data	129

30.20	LSA-026, Packaging Developmental Data	129
30.21	LSA-027, Failure/Maintenance Rate Summary	129
30.22	LSA-030, Indentured Parts List	130
30.23	LSA-032, Defense Logistics Services Center (DLSC) Submittals	133
30.24	LSA-033, Preventive Maintenance Checks and Services (PMCS)	135
30.25	LSA-036, Provisioning Requirements	135
30.26	LSA-037, Spares and Support Equipment Identification List	141
30.27	LSA-039, Critical and Strategic Item Summary	141
30.28	LSA-040, Authorization List Items Summary	141
30.29	LSA-046, Nuclear Hardness Critical Item Summary	142
30.30	LSA-050, Reliability Centered Maintenance Summary	142
30.31	LSA-056, Failure Modes, Effects and Criticality Analysis (FMECA) Report	143
30.32	LSA-058, Reliability and Maintainability Analysis Summary	143
30.33	LSA-065, Manpower Requirements Criteria	144
30.34	LSA-070, Support Equipment Recommendation Data (SERD)	144
30.35	LSA-071, Support Equipment Candidate List	145
30.36	LSA-072, Test Measurement and Diagnostic Equipment (TMDE) Requirements Summary	145
30.37	LSA-074, Support Equipment Tool List	145
30.38	LSA-075, Consolidated Manpower, Personnel and Training Report	146
30.39	LSA-076, Calibration and Measurement Require- ments Summary	146
30.40	LSA-077, Depot Maintenance Interservice Data Summary	147
30.41	LSA-078, Hazardous Materials Summary	147
30.42	LSA-080, Bill of Materials	147
30.43	LSA-085, Transportability Summary	149
30.44	LSA-126, Hardware Generation Breakdown Tree	149
30.45	LSA-151, Provisioning Parts List Index	149
30.46	LSA-152, PLISN Assignment/Reassignment	149
30.47	LSA-154, Provisioning Parts Breakout Summary	152
30.48	LSA-155, Recommended Spare Parts List for Spares Acquisition Integrated with Production (SAIP)	152
APPENDIX C. GUIDANCE FOR ASSIGNMENT OF LOGISTIC SUPPORT		
	ANALYSIS CONTROL NUMBER (LCN), ALTERNATE LCN CODE, LCN TYPE AND USABLE ON CODE (UOC).....	323
10.	PURPOSE	323
10.1	Traditional LCN assignments	323
10.2	Functional and physical LCN assignments: a new perspective	323
20.	LCN ASSIGNMENT	323
20.1	Classical LCN assignment method.....	324
20.2	Modified classical assignment method	324
20.3	Sequential assignment method	324

30.	ALTERNATE LCN CODE (ALC)	328
30.1	ALC usage for a single configuration/model	328
30.2	ALC usage for LSAR reports	330
30.3	Lower tiered LCN/ALC selections	330
40.	LOGISTIC SUPPORT ANALYSIS CONTROL NUMBER	
	TYPE (LCN-TYPE)	330
50.	USABLE ON CODE	330
50.1	ALC And UOC relationship	332
50.2	UOC and ALC usage for LSAR reports	332
60.	SERIAL NUMBER CONTROL AS AN ALTERNATIVE FOR	
	CONFIGURATION MANAGEMENT	332
70.	SUMMARY	334
APPENDIX D.	APPLICATION AND TAILORING GUIDANCE FOR THE	
	LOGISTIC SUPPORT ANALYSIS RECORD (LSAR)	335
10.	GENERAL	335
10.1	Purpose	335
10.2	How to use this appendix	335
20.	LSAR APPLICATION AND USE BY LIFE CYCLE PHASE	335
20.1	LSA process	335
20.2	Pre-concept and concept exploration (CE) phase ...	336
20.3	Demonstration and validation phase	336
20.4	Full scale development (FSD) phase	337
20.5	Production and Deployment Phase	337
30.	TAILORING LSAR REQUIREMENTS	337
30.1	LSA task selection	337
30.2	Interfacing and coordination with other	
	program elements	338
40.	SCHEDULING OF LSAR DATA	339
50.	ALTERNATIVES FOR DATA DELIVERY	340
APPENDIX E.	DATA ELEMENT DICTIONARY	355
10.	PURPOSE	355
20.	SECTIONS	355
20.1	Section 1: Index of data element titles	355
20.2	Section 2: Table of codes and titles	355
20.3	Section 3: Data element definitions	355
APPENDIX F.	LIST OF LOGISTIC SUPPORT ANALYSIS RECORD ACRONYMS	
10.	PURPOSE	563
20.	ACRONYMS	563

FIGURES

Figure		Page
1	LSA data documentation process	2
2	LSAR data flow and system engineering interface ..	3
3	LSAR R&M parameter interface	4
4	X table relationships	27
5	A table relationships	33
6	B table relationships	41
7	C table relationships	54
8	E table relationships	63
9	U table relationships	73
10	F table relationships	82

11	G table relationships	87
12	H table relationships	91
13	J table relationships	106
14	LSAR data tables to report matrix	153
15 thru 62	Standard LSAR reports	193
63	Classical LCN assignment method	325
64	Modified classical LCN assignment method	326
65	Sequential LCN assignment method	327
66	Alternate LCN code usage	329
67	Functional versus physical LCN assignment	331
68	Usable on code and alternate LCN code usage	333
69	LSAR data table utilization by hardware breakdown	342
70	Preconcept and concept exploration phase LSAR	344
71	Example of DD Form 1949-3	571

TABLES

Table		Page
I	LSA-036 report format	136
II	LSAR data tables related to MIL-STD-1388-1 tasks	345
III	Data item description relationships to the LSAR	346

THIS PAGE INTENTIONALLY LEFT BLANK

1. SCOPE.

1.1 Purpose. This standard prescribes the data element definitions (DED), data field lengths, and formats for Logistic Support Analysis (LSA) Record (LSAR) data. It identifies the LSAR reports that are generated from the LSAR data and identifies the LSAR relational tables and automated data processing (ADP) specifications for transmittal and delivery of automated LSAR data.

1.2 Application of standard. This standard applies to all system/equipment acquisition programs, major modification programs, and applicable research and development projects through all phases of the system/equipment life cycle. This standard is for use by both contractor and government activities. As used in this standard, the requiring authority is generally a government activity but may be a contractor when LSA documentation requirements are levied on subcontractors. The performing activity may be either a contractor or government activity. The use of the term, contract, in this standard includes any document of agreement between organizations to include between a government activity and another government activity, between a government activity and a contractor, or between a contractor and another contractor.

1.2.1 Content of appendices. There are six appendices in the standard. Appendix A contains the LSAR relational tables necessary for the development of a relational LSAR database. A description and the required format for each LSAR report is contained in appendix B. All reports contained in appendix B may be generated either manually or via automated techniques by using the LSAR data defined in this military standard. Appendices C, D, and F are guidance appendices covering assignment of the key data elements LSA Control Number (LCN), Alternate LCN Code (ALC), Usable On Codes (UOC); tailoring of the LSAR data; and, LSAR acronyms. Appendix E contains an LSAR Data Element Dictionary providing definitions for all data specified by appendix A. All appendices, except for C, D, and F, establish requirements and can be included/referenced in contractual documents.

1.2.2 Tailoring. This standard shall not be specified in a contract without also specifying MIL-STD-1388-1, LSA. The requiring authority will use MIL-STD-1388-1 in the selection of tasks for inclusion in the contract statement of work (SOW) and shall establish the LSA documentation requirements based upon the elements identified in those tasks. Further tailoring of LSA documentation requirements shall be based on MIL-STD-1388-1 tasks performed in previous program phases, other system engineering program requirements, and logistics related data item descriptions (DID) included in the solicitation document. Detailed guidance on tailoring the LSAR data requirements is included in appendix D.

1.2.3 LSA data documentation process. The LSA process is conducted on an iterative basis through all phases of the system/equipment life cycle to satisfy the support analysis objectives. Similarly, LSA data is generated in all phases of the system/equipment life cycle and is used as input to follow-on analyses and as an aid in developing logistics products. Although automation of the LSAR data as depicted on figure 1 is not mandatory, it is strongly encouraged and should be a consideration in tailoring the LSA data effort. A more detailed display of the LSAR data flow and its interface, with the system engineering and the logistics functional organizations, is

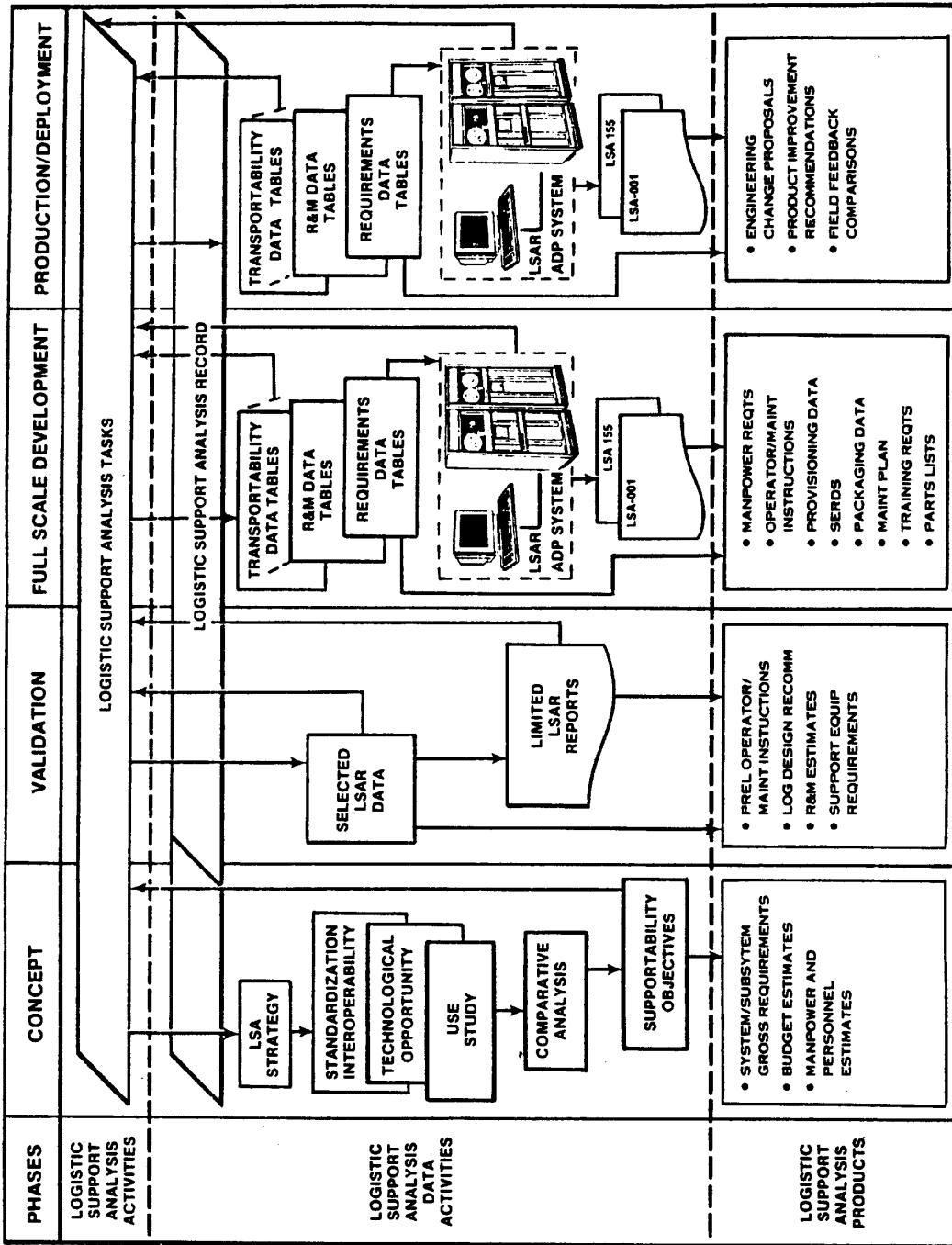

FIGURE 1. LSA data documentation process.

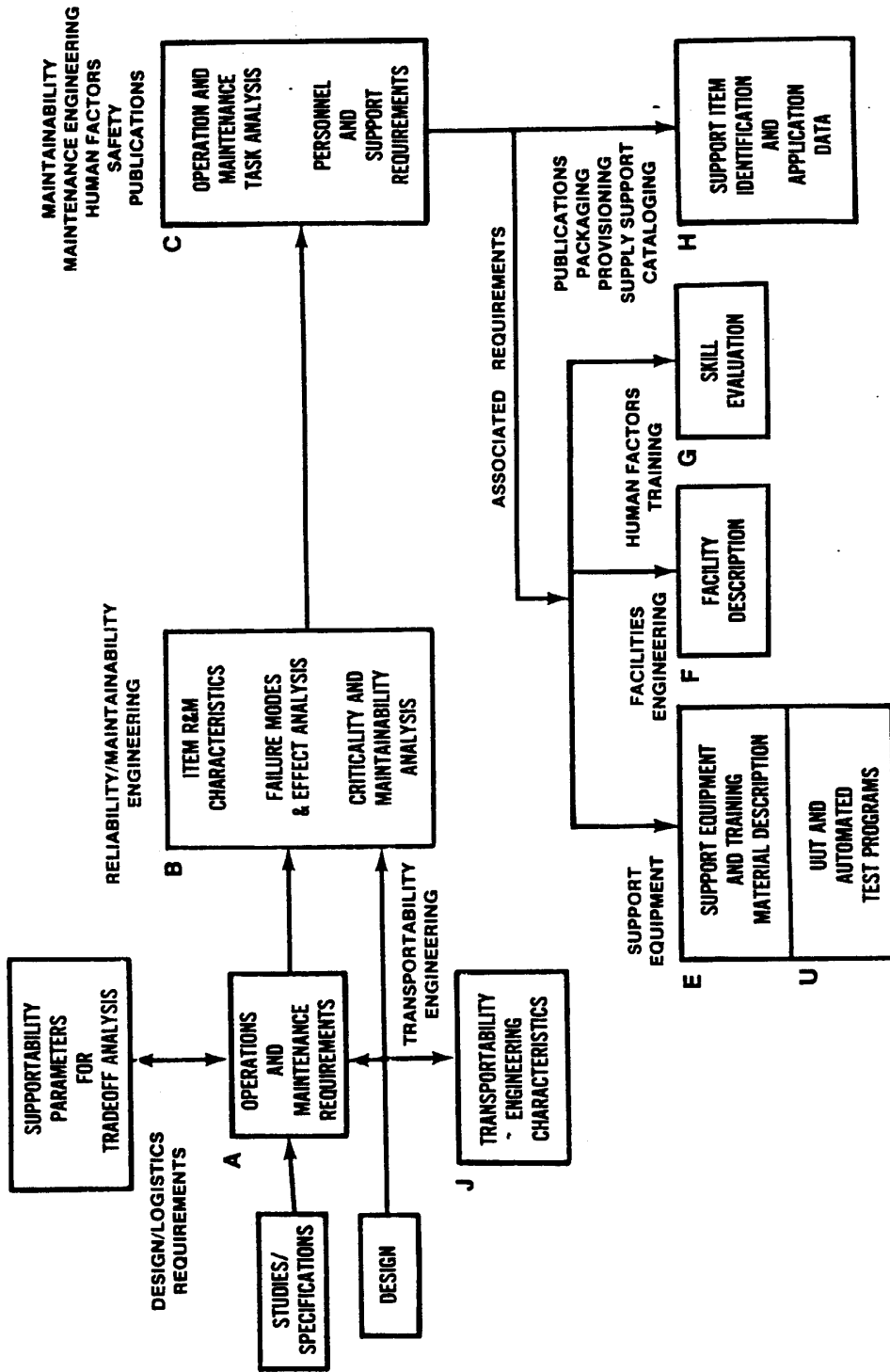

FIGURE 2. LSAR data flow and system engineering interface.

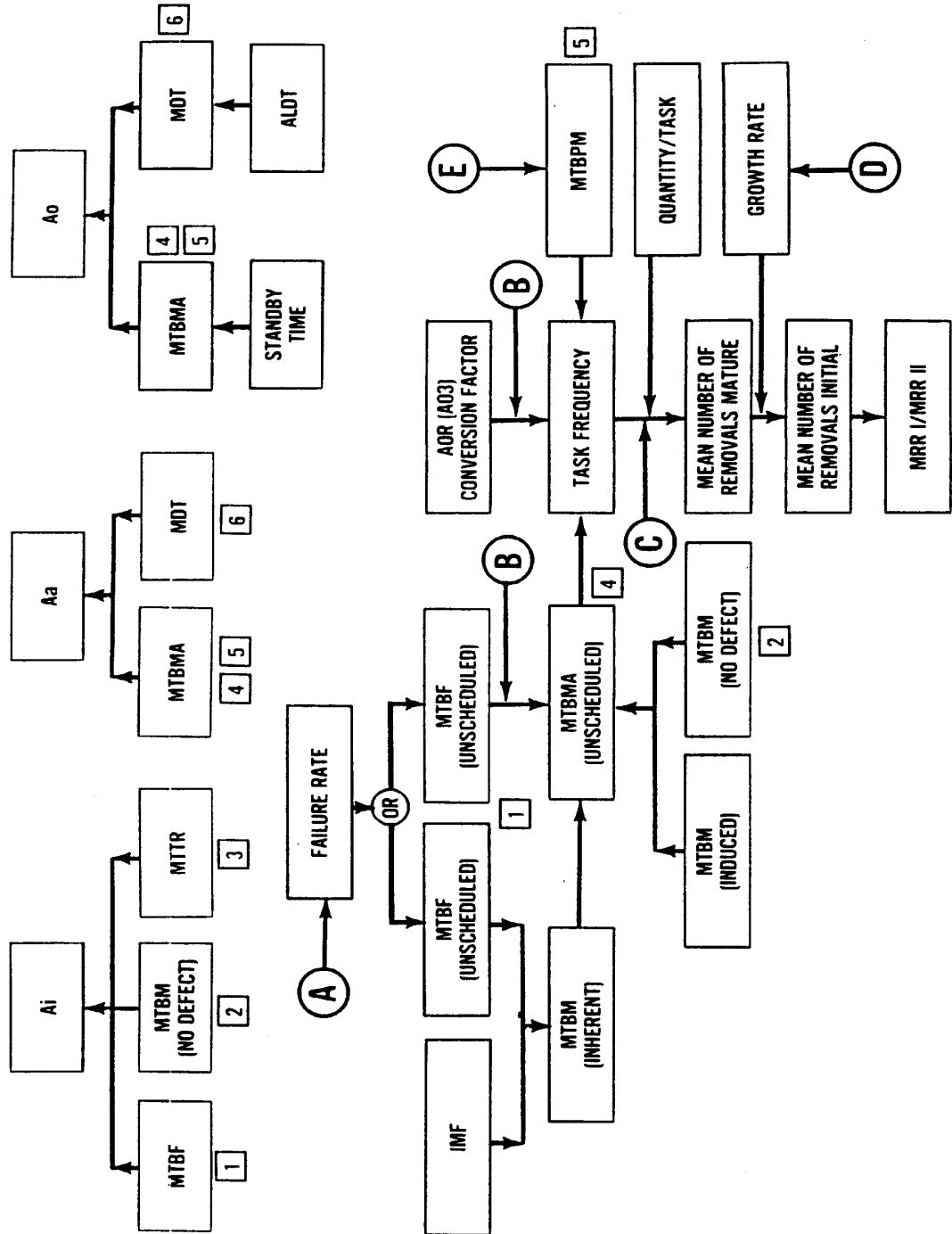
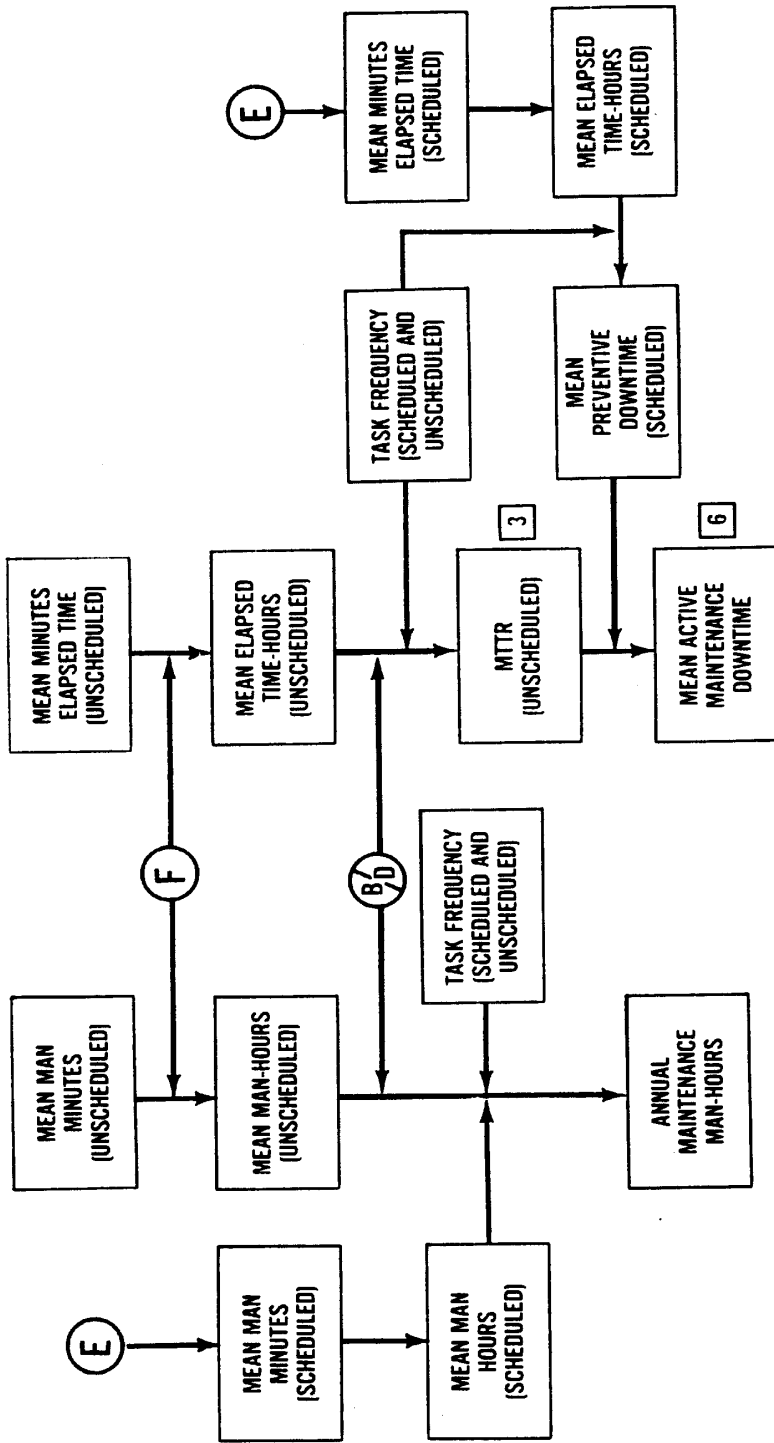

FIGURE 3. LSAR R&M parameter relationships.



SOURCES OF DATA

- (A) MIL-STD-756, RELIABILITY MODELING AND PREDICTION, TEST DATA DATA OR FIELD DATA
- (B) FACTORS FROM COMPARATIVE ANALYSIS
- (C) FACTORS FROM COMPARATIVE ANALYSIS TO ADJUST FOR REMOVALS
- (D) TEST RESULTS
- (E) RCM
- (F) MIL-HDBK-472, MAINTAINABILITY, PREDICTIONS TEST DATA, FIELD DATA

FIGURE 3. LSAR R&M parameter relationships - continued.

provided on figure 2. The figure represents general data table generation relationships and organizational elements normally responsible for generation of LSAR data. Figure 2 should not be misconstrued to mean that one type of data table must be completed in its entirety before the next data table can be completed. For example, certain reliability and maintainability (R&M) estimates included on the B tables must be completed prior to estimating logistics elements on other tables (R&M relationships are shown on figure 3). However, generation of LSAR data is also dependent on the design engineering process and release of drawings (preliminary, development, or final). Completion of B and C tables for a single assembly would provide the information necessary for initiation of data tables associated with support items (H tables), and also data related to support and test equipment (E & U tables), facilities (F tables), and skills evaluation and justification (G tables) when peculiar requirements are identified. The LSAR data flow will be repeated for each repairable item comprising a system/end item until the total logistics data requirements are established.

2. REFERENCED DOCUMENTS.

2.1 General. Completion of the LSAR data requires use of many related documents from which the appropriate data/codes can be obtained. The specific use of each document is identified in the appropriate section or appendix of this standard. Unless otherwise specified, the following standards and handbooks of the issue listed in that issue of the Department of Defense Index of Specifications and Standards (DODISS), specified in the solicitation form, a part of this standard to the extent specified, herein.

Military Standards.

MIL-STD-12	Abbreviations for Use on Drawings, Specifications, Standards, and in Technical Type Publications
DOD-STD-100	Engineering Drawings Practices
MIL-STD-155	Joint Photographic Type Designation System
MIL-STD-196	Joint Electronics Type Designation System
MIL-M-49502	Manuals, Technical: Repair Parts and Special Tools List
MIL-STD-470	Maintainability Program for Systems and Equipment
MIL-STD-482	Configuration Status Accounting Data Elements and Related Features
MIL-STD-785	Reliability Program for Systems and Equipment Development and Production
MIL-STD-815	Designation System for Liquid, Solid and Liquid-Solid (Hybrid) Propellant Rocket Engines and Motors
MIL-STD-875	Type Designation System for Aeronautical and Support Equipment

MIL-STD-879	Designation of Aircraft Propulsion Gas Turbine Engines
MIL-STD-882	System Safety Program Requirements
MIL-STD-965	Parts Control Program
MIL-STD-1388-1	Logistic Support Analysis
MIL-STD-1390	Level of Repair Analysis
MIL-STD-1478	Task Performance Analysis
MIL-STD-1519	Test Requirements Documents, Preparation of
MIL-STD-1629	Procedures for Performing a Failure Mode, Effects and Criticality Analysis
MIL-STD-1839	Calibration and Measurement Requirements
MIL-STD-1843	Reliability Centered Maintenance for Aircraft, Engines, and Equipment
MIL-STD-2073-1	DOD Materiel, Procedures for Development and Application of Packaging Requirements
MIL-STD-2073-2	Packaging Requirement Codes
MIL-STD-2097	Acquisition of Support Equipment and Associated Integrated Logistics Support
MIL-STD-2173	Reliability Centered Maintenance Requirements for Naval Aircraft, Weapon Systems, and Support Equipment
DOD-STD-2121 (Navy)	Determination of Electronic Test Equipment Parameters
<u>Military Handbooks.</u>	
MIL-HDBK-59	Computer-Aided Acquisition and Logistic Support (CALS) Program Implementation Guide
MIL-HDBK-217	Reliability Prediction of Electronic Equipment
<u>Military Specifications.</u>	
MIL-T-31000	Technical Data Packages, General Specifications for
MIL-C-7024	Calibrating Fluid, Aircraft Fuel System Components
MIL-M-63036	Manuals, Technical: Operator's, Preparation of (Army)

MIL-M-63038 Manuals, Technical: Unit or Aviation Unit Direct Support, Aviation Intermediate, and General Support Maintenance, Requirements for

MIL-M-83495 Manuals, Technical: On-Equipment Set, Organizational Maintenance Manuals; Detailed Requirements for Preparation of (For USAF Equipment)

Federal Manuals and Catalogs.

H4/H8 Commercial and Government Entity Code

H6-1 Federal Item Name Directory for Supply Cataloging

(Unless otherwise indicated, copies of federal and military specifications, standards, and handbooks are available from the Standardization Documents Order Desk, Building 4D, 700 Robbins Avenue, Philadelphia, PA, 19111-5094.)

Bulletins.

ANA Bulletin 306 Engines, Aircraft Turbine and Jet, Designation of

ANA Bulletin 395 Engines, Aircraft Reciprocating, Designation of

Other Documents.

DOD 4100.38-M DOD Provisioning and Other Preprocurement Screening Manual

DOD 5000.12-M DOD Manual for Standard Data Elements

DODD 5000.2 Acquisition Management Policies and Procedures

AR 70-50 Designating and Naming Defense Equipment
 NAVMATINST 8800.3 Military Aerospace Vehicles
 AFR 82-5

AR 700-26 Designating and Naming Military Aircraft
 NAVAIRINST 13100.1
 AFR 66-11

AR 700-82 Joint Regulation Governing the Use and Application
 OPNAVINST 4410.2 of Uniform Source Maintenance and Recoverability Codes
 AFR 66-45
 MCO 4400.120
 DSAR 4100.6

NAVFAC P-72 Category Codes for Real Property, Navy

NAVPERS 15839 Manual of Navy Officer Classifications

NAVPERS 18068 Manual of Navy Enlisted Manpower and Personnel Classifications and Occupational Standards

MCO P 1200.7 Military Occupational Specialties

AR 415-28	Department of the Army Facility Classes and Construction Categories
AR 611-101	Manual of Commissioned Officer Military Occupational Specialties
AR 611-112	Manual of Warrant Officer Military Occupational Specialties
AR 611-201	Enlisted Military Occupational Specialties
AFR 36-1	Officer Classification Manual
AFR 39-1	Airman Classification Manual
AFM 86-2	Standard Facility Requirements
FPM Supplement 512-1	Civil Service Commission, Job Grading Standard
SB 700-20	Army Adopted/Other Items Selected for Authorization/List of Reportable Items
JCS PUB 1	Dictionary of United States Military Terms for Joint Usage
DA CPR 502	Department of Army - Civilian Personnel Regulations, Standardized Job Descriptions
DA PAM 700-20	Department of Army - Test, Measurement, and Diagnostic Equipment Register

Industry Documents.

ANSI Y32.16	Reference Designations for Electrical and Electronics Parts and Equipments
-------------	--

(Non-Government standards and other publications are normally available from the organizations that prepare or distribute the documents. These documents also may be available in or through libraries or other informational services.)

3. DEFINITIONS. The LSAR data elements are defined in the description of the LSAR reports contained in appendix B and in the LSAR data element dictionary comprising appendix E of this standard. In addition, for the purposes of this standard, the following definitions shall apply:

3.1 Assembly. A number of parts or subassemblies, or any combination thereof, joined together to perform a specific function and capable of disassembly (e.g., power shovel-front, fan assembly, audio frequency amplifier). NOTE: The distinction between an assembly and subassembly is determined by the individual application. An assembly, in one instance, may be a subassembly in another where it forms a portion of an assembly.

3.2 Attaching part. An item used to attach assemblies or parts to the equipment or to each other.

- 3.3 Component. An assembly or any combination of parts, subassemblies, and assemblies mounted together normally capable of independent operation in a variety of situations.
- 3.4 Design Change. An approved engineering change incorporated into the end item which modifies, adds to, deletes, or supersedes parts in the end item.
- 3.5 End Article/Product. A component, assembly or subassembly being procured as the top item on the contract.
- 3.6 End Item. A final combination of end products, component parts/materials which is ready for its intended use, e.g., ship, tank, mobile machine shop, aircraft, receiver, rifle, or recorder.
- 3.7 LSA Candidate. A component, subassembly, assembly, software, or end item/article on which maintenance action is considered feasible as a result of a preliminary or detailed tradeoff analysis.
- 3.8 LSA Documentation. All data resulting from performance of LSA tasks, conducted under MIL-STD-1388-1, to include LSAR, pertaining to an acquisition program.
- 3.9 Manufacturers Part Number. See reference number.
- 3.10 Part. One, two or more pieces, joined together which are not normally subject to disassembly without destruction or impairment of designed use.
- 3.11 Part Number. See reference number.
- 3.12 Reference Number. Any number, other than a government activity stock number, used to identify an item of production, or used by itself or in conjunction with other reference numbers to identify an item of supply. Reference numbers include: manufacturer's part, drawing, model, type, or source controlling numbers; manufacturer's trade name; specification or standard numbers; and, specification or standard part, drawing, or type numbers. See appendix E, Data Element Definition 337.
- 3.13 Repair Part. Material capable of separate supply and replacement which is required for the maintenance, overhaul, or repair of a system, equipment or end item. This definition does not include Support Equipment, but does include repair parts for support equipment.
- 3.14 Spares. Articles identical to or interchangeable with the end articles on contract which are procured over and above the quantity needed for initial installation for support of a system.
- 3.15 Subassembly. Two or more parts which form a portion of an assembly or a component replaceable as a whole, but having a part or parts which are individually replaceable (e.g., gun mount stand, window recoil mechanism, floating piston, telephone dial, mounting board with mounted parts, power shovel dipper stick).
- 3.16 Support Equipment. "Support Equipment" is that equipment required to make an item, system, or facility operational in its intended environment. This includes all equipment required to maintain and operate the item, system, or facility including aerospace ground equipment and ground equipment.

3.17 Support Items. Items subordinate to or associated with an end item, i.e., spares, repair parts, and support equipment.

3.18 Topdown. A breakdown accomplished by sequencing all parts comprising the end item in a lateral and descending "family tree/generation breakdown". This breakdown shall consist of the end item, including all components, listing every assembly, subassembly, and parts which can be disassembled, reassembled/replaced. All parts are listed in their relation to the end item, component, assembly, or installation system in which they are contained and to their own further sub-subassemblies and parts. This relationship is shown by means of an indenture code.

4. GENERAL REQUIREMENTS. LSA documentation, including LSAR data, is generated as a result of the analysis tasks specified in MIL-STD-1388-1. As such, the LSAR data shall serve as the Integrated Logistic Support (ILS) technical database applicable to all materiel acquisition programs to satisfy the support acquisition. The DEDs, data field lengths, and data formats described in appendices A and E shall be adhered to by the performing activity in establishing the LSAR database. The specific data entry media, storage, and maintenance procedures are left to the performing activity. Validated LSAR ADP systems are available for automated storage of the LSAR data. A list of these LSAR ADP systems may be obtained from the USAMC Materiel Readiness Support Activity, ATTN: AMXMD-EL, Lexington, KY 40511-5101. The LSAR data forms a database to:

- a. Determine the impact of design features on logistics support.
- b. Determine the impact of the proposed logistics support system on the system/equipment availability and maintainability goals.
- c. Provide data for tradeoff studies, life cycle costing, and logistic support modeling.
- d. Exchange valid data among functional organizations.
- e. Influence the system/equipment design.
- f. Provide data for the preparation of logistics products specified by DIDs.
- g. Provide the means to assess supportability of the fielded item.
- h. Provide the means to evaluate the impact of engineering change, product improvement, major modification or alternative proposals.

4.1 LSAR data requirements form. The LSAR data requirements form (DD Form 1949-3, figure 71) provides a vehicle for identifying the required LSAR data elements to be completed and, when applicable, the media of delivery (e.g., floppy disk, magnetic tape, etc.). Preparation of the LSAR data requirements form should be a result of the LSAR tailoring process discussed in appendix D. The data requirements form are used to identify the specific data elements that are required and identified on the relational data tables. In addition, the form will be used to specify the data elements required for each Provisioning Technical Documentation (PTD) list or packaging categorization of items required. Generation of the PTD lists (format shown

as table I, LSA-036 report) may be accomplished manually or via automation techniques. When more than one option of entry for a data element is possible, the options are spelled out as part of the data element dictionary. In a similar manner, the LSAR data requirements form list the options for data elements that have more than one option for entry. Only one option will be specified for a data element with multiple entry options. The LSAR data requirements form will be attached to the contract SOW and attached to the Contract Data Requirements List (CDRL), DD Form 1423, for the applicable DIDs. Detailed instructions for completing DD Form 1949-3 are provided in appendix B, paragraph 20.1 and figure 14.

4.2 LSAR data. The preparation and maintenance of LSAR data is directly related to the hardware and software design of an end item. The requiring authority is responsible for specifying the equipment indenture level and the level(s) of maintenance for which LSAR data will be prepared and maintained. The LSAR data may be prepared and maintained manually, using the LSAR data tables displayed in appendix A, or equivalent formats approved by the requiring authority. It may also be prepared and maintained automatically through use of current computer technology. The decision to automate the LSAR data versus a manual LSAR must take into account the following factors:

- a. Costs and schedules of preparation.
- b. Availability of an ADP system.
- c. Hardware complexity.
- d. Acquisition/life cycle phase.
- e. Requiring authority's schedule requirements.
- f. Design stability.
- g. Compatibility with other LSAR preparers, as well as the requiring authority's ADP system.
- h. Requiring authority involvement.

4.2.1 Manual LSAR data. While not preferred, the LSAR data may be prepared and maintained in hard copy format by using the LSAR data tables displayed in appendix A as guidelines for data groupings. When the LSAR data is prepared and maintained manually, the data displayed on the LSAR tables shall be grouped into LSAR data packages documenting individual reparable assemblies, embedded computer software, and support/test equipment. The LSAR data packages shall be sequenced by LCN. The data displayed on support equipment, facilities, and new or modified skill requirements shall be included in the applicable system/end item LSAR packages, or as directed by the requiring authority. LSAR data displayed on the support item identification and application data shall be sequenced by reference number and LCN within each reference number.

4.2.1.1 Manual LSAR report generation. When required, any or all of the LSAR reports contained in appendix B can be produced in a nonautomated environment. When the LSAR reports are produced by nonautomated means, the reports shall be in accordance with (IAW) the content, format, sequence, and computational requirements contained in paragraph 30 of appendix B.

4.2.2 Automated LSAR data. The LSAR data may be automated and, as such, a validated LSAR ADP system shall be used as follows.

4.2.2.1 Performing activity LSAR ADP system. The performing activity shall use a validated LSAR ADP system. Validation will be accomplished by the USAMC Materiel Readiness Support Activity (MRSA). The systems shall be capable of fulfilling the basic criteria defined in paragraph 4.2.2.2 of this standard. These systems shall be validated by exhibiting processing capability to input, edit, and build LSAR relational tables and output the relational tables and standard LSAR reports. Detailed validation procedures will be provide on request by MRSA.

4.2.2.2 LSAR ADP system criteria. The independently developed LSAR ADP system will be validated based on the following design criteria:

- a. Shall be capable of automatically accepting relational table data in the formats displayed in appendix A, using the data elements, definitions, data element edits, data field lengths, and data relationships contained in appendices A and E.
- b. Shall be capable of producing LSAR reports as displayed in appendix B.
- c. Shall be capable, as a minimum, of satisfying all appendix E data elements.
- d. Shall be capable of outputting LSAR ADP relational tables as displayed in appendix A.
- e. Shall be capable of outputting change only data from last delivery of LSAR data.
- f. Shall provide automated user comment capability.

These minimum design criteria are required to secure system validation. Additional system automation is strongly encouraged.

5. DETAILED INSTRUCTIONS FOR AUTOMATED OR MANUAL PREPARATION OF LSAR RELATIONAL TABLES. These instructions are applicable for either the automated or manual preparation of the LSAR data. Each data table contained in appendix A is identified by a three-position code. The first position of this code identifies the functional area most directly associated with the information contained within the data table. These codes are consistent with the data record letter identifications used in the previous version of this standard, e.g., support item identification is identified by an "H" in the first position of the table code. The second position uniquely identifies the table within a functional area. The third position may be used to insert additional data tables at a later date.

5.1 Requiring authority data tables. Information in the "A" and portions of the "X" tables will be provided by the requiring authority and may be incorporated with the solicitation, or addressed at the LSA/LSAR guidance conference. This information will also be documented on the DD form 1949-3, Figure 71.

5.1.1 Cross functional requirements. These data tables have attributes which cross multiple functional areas or are used as a link to various functional

data tables. The tables are used by the requiring authority to document supply, maintenance and personnel data in support of tradeoff analysis. The individual data elements may be used in conjunction with other LSA data in several LSA models with only minor adjustment, if any, for compatibility of units.

5.1.2 Operations and maintenance requirements. These tables are structured to consolidate the pertinent information related to the anticipated operation of the system, environment in which the system will be operated and maintained, and the system maintenance requirements which must be met. This information is prepared for the system, and for each subsystem for which maintenance requirements are to be imposed, and will also be prepared for government furnished equipment (GFE). When separate operational/maintenance requirements are established for wartime and peacetime scenarios, each set of requirements will be documented as separate table rows. The number of rows of information that will be prepared shall be based on the tasks contained in MIL-STD-1388-1, or as specified by the requiring authority. The performing activity shall incorporate this information into the LSAR and shall complete the appropriate key fields, unless the field has been completed by the requiring authority. Detailed instructions for completion of this information are contained in appendices A and E.

5.2 Performing activity data tables. The performing activity shall complete the required fields of data tables "B", "C", and "E", "F", "G", "H", "J", "U" and portions of the "X" IAW the information contained in appendices A and E and to the extent specified by DD Form 1949-3. When DEDs state that specific information will be provided by the requiring authority, the information may be included in the solicitation or not later than the LSA/LSAR guidance conference.

5.2.1 Reliability, availability, maintainability; failure modes, effects, and criticality analysis; and maintainability analysis. The "B" data tables provide a description of the function of each item within the system; outline the maintenance concept to be utilized for design and support planning purposes; and, identify any design conditions such as fail-safe requirements/ environmental or nuclear hardness considerations imposed upon the system. The tables summarize the reliability, maintainability, and related availability characteristics of the item resulting from the failure modes and effects, criticality, and maintainability analyses, and accommodates a narrative description of any analysis related to the potential redesign of an item. A separate row of information is prepared for the system, for each subsystem contained in the system, and for each level of breakdown for that subsystem until the lowest repairable item has been documented. The degree of breakdown shall be specified by the requiring authority. Additional "B" data tables are designed to accommodate the Failure Modes and Effects Analysis (FMEA), as described by task 101 of MIL-STD-1629. These tables will also accommodate the Damage Mode and Effects Analysis, to be utilized for survivability and vulnerability assessments, as described in task 104 of MIL-STD-1629, and accommodates the criticality and maintainability analyses, as described in tasks 102 and 103 of MIL-STD-1629. The purpose of the criticality analysis is to rank each identified failure according to the combined influence of severity classification and failure probability of occurrence. The relative ranking of the calculated item criticality numbers highlights system high risk items. The maintainability analysis serves as the starting point for maintenance task analysis. The FMEA documents the effects

of an item failure upon system operations and is used to classify each potential failure according to the severity of those effects. The FMEA is initiated as an integral part of the early design process and is derived through a functional analysis. To provide concise information on the failure analysis, functional block diagrams should be provided. Subsequent to this effort, data is prepared to an indenture level, as specified by the requiring authority. The results are used as a guide in evaluating design features and as a basis for initial quantitative predictions. The analysis identifies high risk items, facilitates the evaluation of design features, and provides the basis for criticality and maintainability analyses. The failure effects data are the basis for developing fault location and troubleshooting routines. These tables also document Reliability Centered Maintenance (RCM) logic results and accommodates a narrative description of any analysis related to the potential redesign of an item. These tables are completed to the same indenture level as the item R&M Characteristics tables.

5.2.2. Task inventory, task analysis, personnel and support requirements.

The Operation and Maintenance summary information is used to consolidate the operations and maintenance tasks identified for each reparable assembly and indicates necessary support requirements (e.g., facilities, training equipment, tools, and support equipment). Included are the identification of the combination of all human performances required for operation and maintenance of a one-person position in a system (e.g., A job is that of a driver; one of the duties of a driver is emergency repair; a task within emergency repair is changing a flat tire). The task identification information on these tables is developed from the RCM analysis, maintainability analysis, and from the maintenance task analysis. This information is completed to the same indenture level as the R&M and FMECA Tables. This information is identified on "C" data tables. Additional "C" data tables provide a detailed step-by-step narrative description of how tasks identified on the Task Summary are to be performed, the specific skill specialty requirements, and applicable task man-hours per skill speciality. These tables identify training, personnel, support equipment, and supply support requirements necessary for the accomplishment of the individual tasks. Man-hours per skill specialty are also recorded on these tables. Data on these tables provide information necessary for the development of technical publications, training programs of instruction, supply support, and personnel requirements. This information will be initiated during the detailed system/equipment design effort. For all operational and maintenance level tasks, specific requirements for the completion of the task analysis, including the documentation of maintenance levels, specific hardware items, and indenture levels, will be as specified by the requiring authority. Included in this documentation are the combination of all human performances required for operation and maintenance in a hierarchical breakdown, e.g., mission, scenario, function, job, duty, task, subtask and element, as described in MIL-STD-1388-1.

5.2.3 Support equipment and training material requirements.

Data tables identified by "E" are structured to consolidate the pertinent information related to existing or new support/test equipment or training material, e.g., physical characteristics, calibration requirements, and test parameters. This information also serves as identification of hardware and software elements required to conduct off-line tests.

5.2.4 Unit under test requirements and justification. Data tables "U" are structured to identify the Unit Under Test (UUT), which will be removed from the system and those hardware and software elements required to test the UUT with off-line support/test equipment. The unique combination of these elements required for a specific UUT and support/test equipment configuration is a Test Program Set (TPS). In addition to defining the TPS elements, this information provides configuration identification of the UUT (i.e., UUT, and the support/test equipment to be used in the test). This information is established for each UUT, which has a requirement to be tested by the support/test equipment documented.

5.2.5 Facility considerations. Data tables identified by "F" are used to describe and justify all proposed special or additional facility requirements, which are indicated as a result of the maintenance task analysis. Sketches or other information may be incorporated as part of the hard copy storage by entering the control fields (LCN and task code when applicable) on the supplemental data. These data are required to provide facility designers with the technical information necessary to prepare facility plans.

5.2.6 Personnel skill considerations. Data tables identified by "G" are used to describe and justify any new or modified personnel skills required to support the system/equipment. This information shall be completed for each new or modified skill required as a result of the maintenance task analysis and skill analysis.

5.2.7 Packaging and provisioning requirement. Data tables identified by "H" are used to document the static parts data (nonapplication dependent) related to provisioning screening results, packaging data, price analysis data, parts breakout coding results, and common maintenance data. This information is completed for each item that comprises a system (by reference number) to include, as specified by the requiring authority, reparable items, nonreparable items, bulk materials, common hardware, and common and peculiar support equipment. Additional "H" data tables are used to capture application data of items identified by the static data tables. This information will be prepared for each application of the item in a different next higher assembly and will document that data required for initial support requirements determination, repair parts manual, etc.

5.2.8 Transportability engineering analysis. Data tables identified by "J" are designed to capture the transportability engineering requirements for an end item. This information shall be prepared for the end item in its shipping configuration. In the event the end item is sectionalized for transport, the information shall be completed for each section of the end item. It may also be completed for critical subcomponents or as specified by the requiring authority. External items, which are removed and stored inside the package during transport, are not considered sectionalization for transport.

5.3 LCN assignment and structure. The development of the LCN structure and assignment of individual LCNs is the responsibility of the performing activity, and the resulting structure should be approved by the requiring authority. The LCN structure should represent a topdown generation or functional breakdown of hardware and software IAW the standard engineering drawing structure. LCN sequencing assignment shall adhere to the American Standard Code for Information Interchange (ASCII). Guidance for assignment of LCN, ALC, and UOC are contained in appendix C. This appendix is not

contractual and does not establish requirements. However, the guidance in appendix C should be followed to ensure proper assignment of LCNs for a given system/equipment, as this is critical for successful configuration management and ILS product development.

5.4 LSA/LSAR guidance conference. The purpose of this conference is to ensure the performing activity and requiring authority have a firm understanding of the relationship of the LSA tasks to the LSA documentation, task milestones, and funding levels contractually required. When a guidance conference is not contractually specified and the performing activity desires a conference, the performing activity shall propose a date and place. The proposal shall be submitted within thirty (30) days after contract award. The specific date and place for the guidance conference will be determined by the requiring authority and performing activity. The guidance provided to the performing activity by the requiring authority may include, but shall not be limited to, the following:

- a. Performing activity inquiries relative to contractual LSAR requirements.
- b. Operational and maintenance concepts, i.e., program data.
- c. Baseline logistics data, i.e., available skills, training programs, tools, test equipment, and facilities.
- d. Requirement for joint service validation of the performing activity developed LSAR ADP system, when applicable.
- e. Guidance relative to the use and application of LSAR data elements.
- f. Review of the LSA candidate list.

6. NOTES. (This section contains information of a general or explanatory nature that is helpful, but is not mandatory.)

6.1 Intended use. This standard contains requirements which are applicable to the acquisition of military systems and equipment.

6.2 Issue of DODISS. When this standard is used in acquisition, the issue of the DODISS to be applicable to this solicitation must be cited in this solicitation (see 2.1).

6.3 Consideration of data requirements. The following should be considered when this standard is applied on a contract. The applicable DIDs should be reviewed in conjunction with the specific acquisition to ensure that only essential data are requested/provided and that the DIDs are tailored to reflect the requirements of the specific acquisition. To ensure correct contractual application of the data requirements, a CDRL (DD Form 1423) must be prepared to obtain the data, except where DOD FAR Supplement 27.475-1 exempts the requirement for a DD Form 1423. Refer to appendix D of this standard for suggested tailoring guidance.

<u>Paragraph Number</u>	<u>DID Number</u>	<u>DID Title</u>
5.2	DI-ILSS-81173	Logistic Support Analysis Record (LSAR) Data
Appendix B, 30.1	DI-ILSS-81138A	LSA-001, Annual Man-Hours by Skill Specialty Code and Level of Maintenance
Appendix B, 30.2	DI-ILSS-81139A	LSA-003, Maintenance Summary
Appendix B, 30.3	DI-ILSS-81140A	LSA-004, Maintenance Allocation Chart
Appendix B, 30.4	DI-ILSS-81141A	LSA-005, Support Item Utilization Summary
Appendix B, 30.5	DI-ILSS-81142A	LSA-006, Critical Maintenance Task Summary
Appendix B, 30.6	DI-ILSS-81143A	LSA-007, Support Equipment Requirements
Appendix B, 30.7	DI-ILSS-81144A	LSA-008, Support Items Validation Summary
Appendix B, 30.8	DI-ILSS-81145A	LSA-009, Support Items List
Appendix B, 30.9	DI-ILSS-81146A	LSA-010, Parts Standardization Summary
Appendix B, 30.10	DI-ILSS-81147A	LSA-011, Requirements for Special Training Device
Appendix B, 30.11	DI-ILSS-81148A	LSA-012, Facility Requirements
Appendix B, 30.12	DI-ILSS-81149A	LSA-013, Support Equipment Grouping Number Utilization Summary
Appendix B, 30.13	DI-ILSS-81150A	LSA-014, Training Task List
Appendix B, 30.14	DI-ILSS-81151A	LSA-016, Preliminary Maintenance Allocation Chart
Appendix B, 30.15	DI-ILSS-81152	LSA-018, Task Inventory Report
Appendix B, 30.16	DI-ILSS-81153A	LSA-019, Task Analysis Summary
Appendix B, 30.17	DI-ILSS-81183A	LSA-023, Maintenance Plan Summary
Appendix B, 30.18	DI-ILSS-80119C	LSA-024, Maintenance Plan
Appendix B, 30.19	DI-PACK-80120	Preservation and Packing Data
Appendix B, 30.20	DI-ILSS-81154A	LSA-026, Packaging Developmental Data
Appendix B, 30.21	DI-ILSS-81155A	LSA-027, Failure/Maintenance Rate Summary
Appendix B, 30.22	DI-ILSS-81156A	LSA-030, Indentured Parts Lists
Appendix B, 30.23	DI-ILSS-81286	Provisioning and other Preprocurement Screening Data
Appendix B, 30.24	DI-ILSS-81157A	LSA-033, Preventive Maintenance Checks and Services (PMCS)
Appendix B, 30.25	DI-ILSS-81285	Provisioning Technical Documentation Provisioning Parts List Short Form Provisioning Parts List Long Lead Time Items List Repairable Items List Interim Support Items List Tools and Test Equipment List Common and Bulk Items List Design Change Notices Post Conference List System Configuration Provisioning List
Appendix B, 30.26	DI-ILSS-81158A	LSA-037 Spares and Support Equipment Identification List
Appendix B, 30.27	DI-ILSS-81159A	LSA-039, Critical and Strategic Item Summary
Appendix B, 30.28	DI-ILSS-81160A	LSA-040, Authorization List Items Summary
Appendix B, 30.29	DI-ILSS-81161A	LSA-046, Nuclear Hardness Critical Item Summary
Appendix B, 30.30	DI-ILSS-81162A	LSA-050, Reliability Centered Maintenance Summary

Appendix B, 30.31	DI-ILSS-81163A	LSA-056, Failure Modes, Effects and Criticality Analysis (FMECA) Report
Appendix B, 30.32	DI-ILSS-81164A	LSA-058, Reliability and Maintainability Analysis Summary
Appendix B, 30.33	DI-ILSS-81165A	LSA-065, Manpower Requirements Criteria
Appendix B, 30.34	DI-ILSS-80118C	LSA-070, Support Equipment Recommendation Data (SERD)
Appendix B, 30.35	DI-ILSS-81166A	LSA-071, Support Equipment Candidate List
Appendix B, 30.36	DI-ILSS-80288B	LSA-072, Test, Measurement, and Diagnostic Equipment (TMDE) Requirements Summary
Appendix B, 30.37	DI-ILSS-80289B	LSA-074, Support Equipment Tool List
Appendix B, 30.38	DI-ILSS-80290B	LSA-075, Consolidated Manpower, Personnel and Training Report
Appendix B, 30.39	DI-ILSS-81167A	LSA-076, Calibration and Measurement Requirements Summary
Appendix B, 30.40	DI-ILSS-80291B	LSA-077, Depot Maintenance Interservice Data Summary
Appendix B, 30.41	DI-ILSS-81168A	LSA-078, Hazardous Materials Summary
Appendix B, 30.42	DI-ILSS-81169A	LSA-080, Bill of Materials
Appendix B, 30.43	DI-ILSS-81170A	LSA-085, Transportability Summary
Appendix B, 30.44	DI-ILSS-81171A	LSA-126, Hardware Generation Breakdown Tree
Appendix B, 30.45	DI-ILSS-81287	LSA-151, Provisioning Parts List Index
Appendix B, 30.46	DI-ILSS-81172	LSA-152, PLISN Assignment/Reassignment
Appendix B, 30.47	DI-ILSS-80292B	LSA-154, Provisioning Parts Breakout Summary
Appendix B, 30.48	DI-ILSS-80293B	LSA-155, Recommended Spare Parts List for Spares Acquisition Integrated with Production (SAIP)

The above DIDs were those cleared as of the date of this standard. The current issue of DOD 5010.12-L, Acquisition Management Systems and Data Requirements Control List (AMSDL), must be researched to ensure that only current, cleared DIDs are cited on DD Form 1423.

6.4 Subject term (key word) listing.

Provisioning
 CALS
 Support equipment
 Task analysis
 Training
 Transportability

6.5 Supersession data. This standard includes the requirements of MIL-STD-1388-2A, dated 20 Jul 84.

6.6 Changes from previous issue. Marginal notations are used in this revision to identify changes with respect to the previous issue.

CONCLUDING MATERIAL

Custodians:

Army - TM
Navy - AS
Air Force - 95

Preparing Activity:

Army - TM

(Project No. ILSS-0003)

Review Activities:

Army - ME, MI, AV, AT, CR
Navy - SH, YD, OS, MC
Air Force - 11, 13, 15, 16, 17
Miscellaneous DOD/NASA - DH, NS, NA, DS, DC

APPENDIX A

LOGISTIC SUPPORT ANALYSIS RECORD RELATIONAL TABLES

10. SCOPE. This appendix establishes the Logistic Support Analysis (LSA) Record (LSAR) relational table titles and data content and format to be produced by an LSAR relational Automated Data Processing (ADP) system. It defines all the relational tables that comprise an LSAR database.

20. CONCEPT. In a relational database system, information is organized in the form of tables. Categories or columns of information are listed across the top of each table. Individual sets of information are listed as rows. LSAR relational tables are two-dimensional matrices of related data. Tables are defined in terms of columns (or data element definitions (DED)) and rows (or multiple sets of the columnar data elements). Information in this format can be easily visualized and understood. Within each table, certain data may be defined as foreign key, or key, e.g., required to be present when a new row of data is established. These data keys comprise a unique set of identifiers for each row of information in the data table. Relational tables are structured according to the data associations which dictate the table configuration. Although each relational table is independent and equal, data integrity rules will dictate that a row of information be established in a table from which foreign keys originate, prior to the establishment of the lower-tiered data table. The interrelationships and data hierarchy between tables are only established through common data element keys and data values. The tables listed in this appendix comprise the total LSAR relational database.

30. RELATIONAL DATA TABLES FORMAT. The relational tables are shown in this appendix by functional areas in the following sequence:

- a. X, Cross functional requirement
- b. A, Operations and maintenance requirement
- c. B, Reliability, availability, and maintainability; failure modes, effects, and criticality analysis; and, maintainability analysis
- d. C, Task inventory, task analysis, personnel and support requirements
- e. E, Support equipment and training materiel requirements
- f. U, Unit under test requirements and description
- g. F, Facilities considerations
- h. G, Personnel skill considerations
- i. H, Packaging and provisioning requirement
- j. J, Transportability engineering analysis

30.1 Functional LSAR relational table listing and table relationships. Preceding the data tables for each functional area are a listing of the applicable data tables and an illustration showing the data table

relationships. The listing contains each LSAR relational table code and title. These table codes cannot be modified when establishing/creating a relational LSAR ADP System. This list of relational tables comprises the LSAR database. Each figure depicts the table title and code. Starting at the top of the figure, table keys are migrated down to each successive level of related tables shown through line relationships. Only additional keys are shown as you progress from top to bottom (e.g., figure 4, contains table XB. This table has data keys End Item Acronym Code (EIAC) (migrated from table XA) and LSA Control Number (LCN), Alternate LCN Code (ALC), and LCN Type (listed beneath the line in the table block)).

30.2 LSAR relational tables. The detailed portion of each functional area contains each LSAR table, a brief description of the table contents and business rules, and the format and content of the table elements. Each table contains the following entries:

- a. Table code
- b. Table title
- c. Table description
- d. Columnar listing of the table contents
 - (1) DED code
 - (2) Data element title or role name
 - (3) Data element field format
 - (4) DED number
 - (5) Key indicator

30.2.1 Format. The general format for the relational tables is as follows:

TABLE CODE TABLE TITLE

(Description of table)

CODE DATA ELEMENT TITLE/ROLE NAME FORMAT DED KEY

30.2.2 Definition of Terms.

30.2.2.1 Table Code. The three-position code, left-justified, assigned to each table in the relational LSAR used for locating and referencing the data elements to the appropriate relational LSAR table in the DED cross-reference index.

30.2.2.2 Table Title. A descriptive phrase used to identify the relational table. Sufficient adjectival modifiers are used with the phrase to ensure unique identification.

30.2.2.3 Table Description. A short statement outlining the contents and associated business rules of the data table.

30.2.2.4 Data Element Code (CODE). A nine-position code, left-justified, used to identify the DED. Each DED Code is unique within the table in which the DED is listed. The DED Code cannot be changed or modified when independently developing a relational LSAR ADP System. The last three positions of the code are the table code. When a key migrates to a new table, thus becoming a foreign key, it will retain the table code where the key originated, unless the key is required to assume a "roll name" in the new table. Origination of foreign keys which assume roll names are defined in the business rules for the data table.

30.2.2.5 Data Element Title. The noun phrase used to identify the data element. Sufficient modifiers are used with the noun name to ensure title uniqueness for a specific data element definition.

30.2.2.6 Field Format. A specification for the length, type, positional justification, and decimal placement of a data element field, or subfield thereof, as described below:

a. Length. The number of character positions in the data element. In the event the length is variable, the maximum length is specified.

b. Type. A specification of the character type, wherein:

"A" specifies that all characters of the data field, except narrative fields, are upper case alphabetical.

"N" specifies that all characters of the data field are numerical.

"X" specifies that characters of the data field are upper case alphabetical (except narrative fields), numerical, special, or any combination thereof.

"D" specifies that characters of the data field are numerical with floating decimal. Decimals may be entered as required or exponentially, e.g., "0.0000325" or "3.25E-5".

c. Justification. Specifies from which side of the field the characters of the data element are entered. Those starting at the left are left justified (L), those starting at the right are right justified (R); and, those which always occupy the entire field are fixed (F). A dash (-) is used if this column is not applicable.

d. Decimal Placement. Specifies the number of character positions to the right of the assumed decimal point when the data element is numeric in all character positions with a fixed decimal location. A dash (-) is used if this column is not applicable. AS means "As Specified" and the detailed instructions will indicate the location of decimal points.

e. Field formats for extended narrative data fields are capable of accepting a maximum of 99,999, 65-character lines, of information by means of a text sequencing code.

30.2.2.7 DED Number. A sequentially assigned number to each data element in the dictionary for use in locating and referencing it throughout the dictionary and the relational data tables.

30.2.2.8 Key Data Element Code (KEY). An indicator that identifies key and mandatory data within a data table. The indicators are "F", foreign key, "K", key, or "M", mandatory, nonidentifying data element. Key data cannot have a null value (unless specified in the business rules) when attempting to establish a data row in a given data table.

30.2.2.9 Role Name. A unique modifier of a data element title which describes the use/application of the data element within a specific relational data table location.

30.3 LSAR Data Table Exchange/Delivery. Depending upon contractual language, exchange/delivery of the LSAR data may take the form of full file replacement or "change only" data (changes to the MIL-STD-1388-2B data tables since the previous submittal of the LSAR data). Both capabilities are required of validated MIL-STD-1388-2B LSAR systems. Validated LSAR systems may employ table upload edits differently; therefore, each system shall be responsible for sorting tables of imported LSAR files as necessary to pass their table upload edits. Also, LSAR data tables shall be exchanged/delivered via variable length ASCII file formats. All data elements shall be positioned at their respective offsets in the table row field. The following paragraphs define the requirements to insure that automated LSAR systems will produce and load standard outputs not only for all data tables (full file replacement), but also standard outputs for "change only" data. Each type of transaction shall be identified by the use of an update code (UC); multiple transactions are possible for "change only" data delivery. The UC is not a data element within each relational table; instead, the UC appends the appropriate table row(s) identifying the transactions which have occurred.

30.3.1 Full file replacement. When providing an initial LSAR file delivery or a full file replacement, a UC = * must be present for the appropriate row of Table XA. The file structure for full file replacement is as follows:

```
|UC|Table ID|Table Row|
```

The UC (*) identifies the type of transaction as being full file replacement or initial delivery. The Table ID is XA in this case and the Table Row only needs the key data element (EIAC) input. Each element of the transaction shall be contiguous and without the vertical lines shown above.

30.3.2 Change only data delivery. "Change only" data delivery requires multiple types of change transactions. Each type of change transaction is listed below with its definition and appropriate UC.

a. Add Transaction - UC = A. The Add Transaction Code identifies that the record to be loaded is a new record to be added to the respective table. The appearance of an add implies that the key data elements do not already exist in the table being accessed. However, those key data elements must already exist in the prerequisite tables. The add record shall contain required key fields and shall invoke a full record insert to specified table.

b. Delete Transaction - UC = D. The Delete Transaction Code identifies the transaction record as a delete of an existing record pertaining to the identified key data elements. If the table is prerequisite to another table and there is data in the other table matching on the identified keys, this transaction shall not delete the data in the specified table. A global delete transaction (identified below) shall delete table records and associated

subordinate table records with respect to identified key data elements.

c. Element Change Transaction - UC = C. The appearance of an Element Change Transaction Code for a given table and keys implies that data already exists and is being modified. An Element Change Transaction shall only contain data in the key fields and the fields which are being modified. The Element Change Transaction shall update only the specified data element(s).

d. Element Delete Transaction - UC = X. If deletion of one or more data elements from a table is desired, each element will contain a "D" in the first position of its respective table position. An Element Delete Transaction shall also contain the appropriate key data for the specified data table. The Element Delete Transaction shall delete only the specified data element(s).

e. Global Delete Transaction - UC = R. In the Global Delete Transaction, the identified key data shall be deleted from the specified table as well as from all tables which are subordinate to the specified table.

f. File Structure for Change Transactions A, D, C, X, and R. The following file structure shall be used for the subject change transactions:

```
|UC|Table ID|Table Row|
```

The UC (A, D, C, X, or R) identifies the type of transaction. The Table ID is the data table identification (i.e., XB, CA, etc.). The Table Row is self explanatory for each type of transaction. Each element of the transaction shall be contiguous and without the vertical lines shown above.

g. Key Field Change Transaction - UC = K. In the Key Field Change Transaction, the identified key data shall be changed in the specified table as well as in all tables which are subordinate to the specified table. If a key data element in the specified table has a foreign key identification, the "Change To" key data element (see file structure in next paragraph) must be established in the foreign key file (and other prerequisite files) before the change can be implemented (e.g., changing an existing LCN to a new LCN can only be accomplished in Table XB, where LCN is first introduced as a key data element).

h. File Structure for Change Transaction K. The following file structure shall be used for Key Field Change Transactions:

```
|UC|Table ID|Table Row "Change From"|Table Row "Change To"|  
          |Key Values                |Key Values                |
```

The UC (K) identifies the transaction as a Key Field Change Transaction. The Table ID is the data table identification. The Table Row "Change From" Key Values are the identified table key values which exist in the table and are to be changed. The Table Row "Change To" Key Values are values to which all applicable table keys are being changed. Each element of the transaction shall be contiguous and without the vertical lines shown above.

30.3.2.1 Update code sort order. The order for the incorporation of change transactions into a database is critical and shall be dependent upon the UC. The UC sort order is R, K, D, X, A, and C.

MIL-STD-1388-2B
APPENDIX A

40. CROSS FUNCTIONAL REQUIREMENT. The following "X" data tables have attributes which cross multiple functional areas or are used as a link to various functional data tables. Included under these tables are the functional and physical breakdown LCN, assignment and application of UOCs, technical manual numbers, and government provided level of repair analysis (LORA) modeling information. Figure 4 depicts the key relationships for these tables.

<u>TABLE CODE</u>	<u>TABLE TITLE</u>
XA	End Item Acronym Code
XB	LCN Indentured Item
XC	System/End Item
XD	System/End Item Serial Number
XE	LCN to Serial Number Usable On Code
XF	LCN to System/End Item Usable On Code
XG	Functional/Physical LCN Mapping
XH	Commercial and Government Entity
XI	Technical Manual Code and Number Index

40.1 Table XA, End Item Acronym Code. This table contains the EIAC (EIACODXA) used to define the LSAR system documented in the relational database. Also included in this table are LORA modeling parameters provided by the requiring authority. When the classical or modified classical LCN assignment is used (see Appendix C), then an entry is required in LCN structure (LCNSTRXA).

<u>CODE</u>	<u>DATA ELEMENT TITLE</u>	<u>FORMAT</u>	<u>DED</u>	<u>KEY</u>
EIACODXA	END ITEM ACRONYM CODE	10 X L -	096	K
LCNSTRXA	LCN STRUCTURE	18 N L -	202	
ADDLTMXA	ADMINISTRATIVE LEAD TIME	2 N R -	014	
CTDLTMXA	CONTACT TEAM DELAY TIME	3 N R -	052	
CONTNOXA	CONTRACT NUMBER	19 X L -	055	
CSREORXA	COST PER REORDER ACTION	4 N R 2	061	
CSPRRQXA	COST PER REQUISITION	4 N R 2	062	
DEMILCXA	DEMILITARIZATION COST	2 N R -	077	
DISCNTXA	DISCOUNT RATE	3 N R 2	083	
ESSALVXA	ESTIMATED SALVAGE VALUE	2 N R -	102	
HLCSPCXA	HOLDING COST PERCENTAGE	2 N R -	160	
INTBINXA	INITIAL BIN COST	4 N R -	166	
INCATCXA	INITIAL CATALOGING COST	4 N R -	167	
INTRATXA	INTEREST RATE	3 N R 2	173	
INVSTGXA	INVENTORY STORAGE SPACE COST	4 N R 2	176	
LODFACXA	LOADING FACTOR	3 N R 2	195	
WSOPLVXA	OPERATION LEVEL	2 N R -	271	

MIL-STD-1388-2B
APPENDIX A

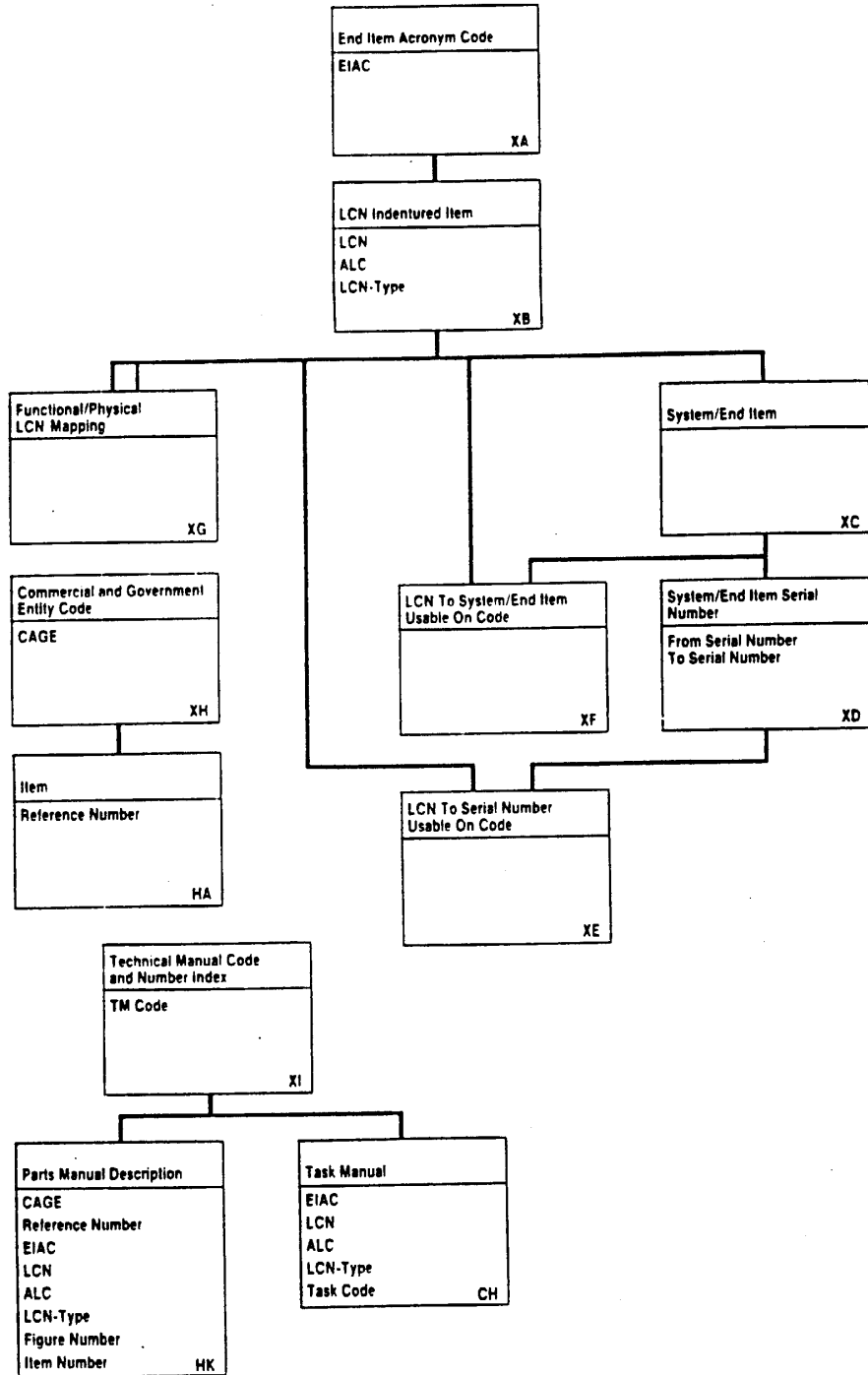

MIL-STD-1388-2B
APPENDIX A

OPRLIFXA	OPERATION LIFE	2 N R -	272
PRSTOVXA	PERSONNEL TURNOVER RATE/CIV	2 N R -	289
PRSTOMXA	PERSONNEL TURNOVER RATE/MIL	2 N R -	289
PROFACXA	PRODUCTIVITY FACTOR	3 N R 2	300
RCBINCX	RECURRING BIN COST	4 N R -	333
RCCATCXA	RECURRING CATALOGING COST	4 N R -	334
RESTCRXA	RETAIL STOCKAGE CRITERIA	2 N R -	359
SAFLVLXA	SAFETY LEVEL	2 N R -	363
SECSFCXA	SUPPORT OF SUPPORT EQUIPMENT COST FACTOR	3 N R 2	421
TRNCSTXA	TRANSPORTATION COST	4 N R 2	466
WSTYAQXA	TYPE ACQUISITION	1 A F -	478
TSSCODXA	TYPE OF SUPPLY SYSTEM CODE	1 A F -	484

40.2 Table XB, LSA Control Number Indentured Item. This table contains all LCNs and information about the indentured location of the LCN in the hardware/functional configuration of the system/equipment. Table keys include: EIAC (EIACODXA); LCN (LSACONXB); ALC (ALTLCNXB); and, LCN Type (LCNTYPXB).

a. If LCN Structure from table XA (LCNSTRXA) is blank, LCN Indenture Code (LCNINDXB) is mandatory.

b. If LCN Structure is not blank, the LCN (LSACONXB) must match an indenture level length specified by the LCN Structure, or be a greater length than the total of all LCN Structure indenture levels, e.g., if the LCN Structure is "12233", an LCN must be either 1, 3, 5, 8, 11, or greater than 11 positions. If the LCN is greater than 11 positions, the LCN Indenture Code becomes mandatory.

<u>CODE</u>	<u>DATA ELEMENT TITLE</u>	<u>FORMAT</u>	<u>DED</u>	<u>KEY</u>
EIACODXA	END ITEM ACRONYM CODE	10 X L -	096	F
LSACONXB	LSA CONTROL NUMBER (LCN)	18 X L -	199	K
ALTLCNXB	ALTERNATE LCN CODE	2 N F -	019	K
LCNTYPXB	LCN TYPE	1 A F -	203	K
LCNINDXB	LCN INDENTURE CODE	1 A F -	200	
LCNAMEXB	LCN NOMENCLATURE	19 X L -	201	
TMFGCDXB	TECHNICAL MANUAL FUNCTIONAL GROUP CODE (MAINTENANCE ALLOCATION CHART)	11 X L -	438	
SYSIDNXB	SYSTEM/END ITEM IDENTIFIER	1 A F -	423	
SECITMXB	SECTIONALIZED ITEM TRANSPORTATION INDICATOR	1 A F -	367	
RAMINDXB	RELIABILITY AVAILABILITY MAIN- TAINABILITY INDICATOR	1 A F -	342	

40.3 Table XC, System/End Item. This table contains only those LCNs representing a system/End Item (EI) or "A" indenture coded item. A system/EI is an item capable of independent operation for its intended use, e.g., rifle, radio receiver, or is a class or group of equipment that is managed and provisioned under a separate Provisioning Contract Control Number (PCCN). Table keys include: EIAC (EIACODXA); LCN (LSACONXB); ALC (ALTLCNXB); and, LCN Type (LCNTYPXB).

MIL-STD-1388-2B
APPENDIX A

a. The System/EI Identifier (SYSIDNXB) of "S" or "E" identifies LCNs as representing System/EIs from table XB for entry into this table.

b. For identical PCCNs (PCCNUMXC), the UOCs (UOCSEIXC) must be different.

c. All alternate assemblies of the same LCN must have the same PCCN.

<u>CODE</u>	<u>DATA ELEMENT TITLE</u>	<u>FORMAT</u>	<u>DED</u>	<u>KEY</u>
EIACODXA	END ITEM ACRONYM CODE	10 X L -	096	F
LSACONXB	LSA CONTROL NUMBER (LCN)	18 X L -	199	F
ALTLCNXB	ALTERNATE LCN CODE	2 N F -	019	F
LCNTYPXB	LCN TYPE	1 A F -	203	F
UOCSEIXC	USABLE ON CODE	3 X L -	501	M
PCCNUMXC	SYSTEM/EI PROVISIONING CONTRACT CONTROL NUMBER	6 X F -	307	M
ITMDESXC	SYSTEM/EI ITEM DESIGNATOR CODE	26 X L -	179	
PLISNOXC	SYSTEM/EI PROVISIONING LIST ITEM SEQUENCE NUMBER	5 X L -	309	
TOCCODXC	SYSTEM/EI TYPE OF CHANGE CODE	1 A F -	481	
QTYASYXC	SYSTEM/EI QUANTITY PER ASSEMBLY	4 X - -	316	
QTYPEIXC	SYSTEM/EI QUANTITY PER END ITEM	5 X - -	317	
TRASEIXC	TRANSPORTATION END ITEM INDICATOR	1 A F -	467	

40.4 Table XD, System/End Item Serial Number. This table is only used when parts configuration control is managed by serial numbers (S/N) of a system/EI. It contains Serial Numbers applicable to a System/End Item, and if required, Serial Number UOC assignments, e.g., for model V10, identified in table XC, applicable serial numbers may be 110 through 118, 121 and 125-130, while for model V10A, also identified in table XC, the applicable serial numbers may be 119, 122-124, and 131-150. For these serial number(s) specific serial number UOCs may be assigned as follows:

Model (ITMDESXC)	Serial Number UOC (SNUUOCXD)	Serial Number(s)	
		(FRSNUMXD)	(TOSNUMXD)
V10	A	110 - 118	
V10	B	121 - 121	
V10	C	125 - 130	
V10A	D	119 - 119	
V10A	E	122 - 124	
V10A	F	131 - 150	

a. S/N From (FRSNUMXD) must be less than or equal to S/N To (TOSNUMXD).

b. S/N UOCs must be different for all EIAC, LCN, ALC and LCN Type combinations within the same PCCN (pulled from table XC for subject keys).

<u>CODE</u>	<u>DATA ELEMENT TITLE</u>	<u>FORMAT</u>	<u>DED</u>	<u>KEY</u>
EIACODXA	END ITEM ACRONYM CODE	10 X L -	096	F
LSACONXB	LSA CONTROL NUMBER (LCN)	18 X L -	199	F
ALTLCNXB	ALTERNATE LCN CODE	2 N F -	019	F
LCNTYPXB	LCN TYPE	1 A F -	203	F

MIL-STD-1388-2B
APPENDIX A

FRSNUMXD	SERIAL NUMBER FROM	10 X L -	373	K
TOSNUMXD	SERIAL NUMBER TO	10 X L -	373	K
SNUUOCXD	SERIAL NUMBER USABLE ON CODE	3 A L -	375	M

40.5 Table XE, LCN to Serial Number Usable On Code. This table contains LCN and system/EI S/N LCNs in order to determine the associated S/N and S/N UOCs for the LCN. Table keys include all columns.

a. Table keys LSACONXE, ALTLCNXE, and LCNTYPXE migrate from table XB. Table keys LCNSEIXE, ALCSEIXE, and LTYSEIXE migrate from table XD. EIACODXA is identical for keys from tables XB and XD for a given row of data.

b. Rows of information from this table with LCNTYPXE and LTYSEIXE of "P" must match entries in table HN, when this table is established.

<u>CODE</u>	<u>DATA ELEMENT TITLE</u>	<u>FORMAT</u>	<u>DED</u>	<u>KEY</u>
EIACODXA	END ITEM ACRONYM CODE	10 X L -	096	F
LSACONXE	S/N ITEM LSA CONTROL NUMBER (LCN)	18 X L -	199	F
ALTLCNXE	S/N ITEM ALTERNATE LCN CODE	2 N F -	019	F
LCNTYPXE	S/N ITEM LCN TYPE	1 A F -	203	F
LCNSEIXE	S/N SYSTEM/EI LCN	18 X L -	199	F
ALCSEIXE	S/N SYSTEM/EI ALC	2 N F -	019	F
LTYSEIXE	S/N SYSTEM/EI LCN TYPE	1 A F -	203	F
FRSNUMXE	S/N SERIAL NUMBER FROM	10 X L -	373	F
TOSNUMXE	S/N SERIAL NUMBER TO	10 X L -	373	F

40.6 Table XF, LCN to System/End Item Usable On Code. This table contains LCNs and System/EI LCNs in order to determine the associated UOC for the LCN. This table and table HO (for provisioning) are critical to qualify an LCN for report requests when a specific UOC is required for report selection. Table keys include all columns.

a. Table keys LSACONXF, ALTLCNXF, and LCNTYPXF originate in table XB. Table keys LCNSEIXF, ALCSEIXF, and LTYSEIXF migrate from table XC. EIACODXA is identical for keys from tables XB and XC for a given row of data.

b. Rows of information from this table with LCNTYPXF and LTYSEIXF of "P" must match entries in table HO, when this table is established.

<u>CODE</u>	<u>DATA ELEMENT TITLE</u>	<u>FORMAT</u>	<u>DED</u>	<u>KEY</u>
EIACODXA	END ITEM ACRONYM CODE	10 X L -	096	F
LSACONXF	UOC ITEM LSA CONTROL NUMBER (LCN)	18 X L -	199	F
ALTLCNXF	UOC ITEM ALTERNATE LCN CODE	2 N F -	019	F
LCNTYPXF	UOC ITEM LCN TYPE	1 A F -	203	F
LCNSEIXF	UOC SYSTEM/EI LCN	18 X L -	199	F
ALCSEIXF	UOC SYSTEM/EI ALC	2 N F -	019	F
LTYSEIXF	UOC SYSTEM/EI LCN TYPE	1 A F -	203	F

40.7 Table XG, Functional/Physical LCN Mapping. This table contains a cross-listing of functional/physical LCNs. All data, except EIACODXA, originate in

MIL-STD-1388-2B
APPENDIX A

table XB. EIACODXA is identical for all keys and mandatory data elements across a given row of data. Physical LCN Type must always be "P"; Functional LCN Type must always be "F". When a functional and physical LCN are mapped through this table, all data contained against the functional LCN shall migrate to the physical LCN (physical LCN data shall take precedence if data duplication has occurred). After the data is migrated, data additions and updates for this item shall only occur against the physical LCN.

<u>CODE</u>	<u>DATA ELEMENT TITLE</u>	<u>FORMAT</u>	<u>DED</u>	<u>KEY</u>
EIACODXA	END ITEM ACRONYM CODE	10 X L -	096	F
PLSACNXG	PHYSICAL LSA CONTROL NUMBER (LCN)	18 X L -	199	F
PALCNCXG	PHYSICAL ALTERNATE LCN CODE	2 N F -	019	F
PLCNTYXG	PHYSICAL LCN TYPE	1 A F -	203	F
FLSACNXG	FUNCTIONAL LSA CONTROL NUMBER	18 X L -	199	M
FALCNCXG	FUNCTIONAL ALTERNATE LCN CODE	2 N F -	019	M
FLCNTYXG	FUNCTIONAL LCN TYPE	1 A F -	203	M

40.8 Table XH, Commercial and Government Entity Code. This table contains all Commercial And Government Entity (CAGE) codes and the CAGE addresses. A CAGE street (CASTREXH), city (CACITYXH), state (CASTATXH), nation (CANATNXH), or postal zone (CAPOZOXH) cannot be included without a CAGE name (CANAMEXH).

<u>CODE</u>	<u>DATA ELEMENT TITLE</u>	<u>FORMAT</u>	<u>DED</u>	<u>KEY</u>
CAGECDXH	COMMERCIAL AND GOVERNMENT ENTITY (CAGE) CODE	5 X F -	046	K
CANAMEXH	CAGE NAME	25 X L -	047	
CASTREXH	CAGE STREET	25 X L -	047	
CACITYXH	CAGE CITY	20 X L -	047	
CASTATXH	CAGE STATE	2 A F -	047	
CANATNXH	CAGE NATION	20 X L -	047	
CAPOZOXH	CAGE POSTAL ZONE	10 X L -	047	

40.9 Table XI, Technical Manual Code and Number Index. This table contains a cross-reference of TM code to TM number(s). Table keys include both columns.

<u>CODE</u>	<u>DATA ELEMENT TITLE</u>	<u>FORMAT</u>	<u>DED</u>	<u>KEY</u>
TMCODEXI	TM CODE	3 X F -	437	K
TMNUMBXI	TM NUMBER	30 X L -	440	

MIL-STD-1388-2B
APPENDIX A

50. OPERATIONS AND MAINTENANCE REQUIREMENTS. Data tables beginning with "A" in the first position of the table code are structured to consolidate information related to the anticipated operation of the system, environment in which the system will be operated and maintained, and maintenance requirements of the system which must be met. This information is prepared for the system and for each subsystem for which maintenance requirements are to be imposed. Figure 5 depicts the relational hierarchy of these tables/entities.

<u>TABLE CODE</u>	<u>TABLE TITLE</u>
AA	Operations and Maintenance Requirements
AB	War Peace Operations and Maintenance Requirement
AC	Maintenance Level Requirement
AD	Organizational Level Requirement
AE	Skill Operations and Maintenance Requirement
AF	War Peace Additional Requirements Narrative
AG	Reliability Requirement
AH	Interoperability Requirement
AI	Modeling Data
AJ	Operations and Maintenance Shipping Requirements
AK	System End Item Narrative

50.1 Table AA, Operations and Maintenance Requirement. This table identifies operations, maintenance, and reliability requirements for the new system/equipment by the service designator code. Table keys consist of EIAC (EIACODXA), LCN (LSACONXB), ALC (ALTLCNXB), LCN Type (LCNTYPXB), and Service Designator Code (SERDESAA). For a given row of information, Percentile (PERCENAA) is not allowed without a Maximum Time to Repair (MAXTTRAA).

<u>CODE</u>	<u>DATA ELEMENT TITLE</u>	<u>FORMAT</u>	<u>DED</u>	<u>KEY</u>
EIACODXA	END ITEM ACRONYM CODE	10 X L -	096	F
LSACONXB	LSA CONTROL NUMBER (LCN)	18 X L -	199	F
ALTLCNXB	ALTERNATE LCN CODE	2 N F -	019	F
LCNTYPXB	LCN TYPE	1 A F -	203	F
SERDESAA	SERVICE DESIGNATOR CODE	1 A F -	376	K
MAXTTRAA	REQUIRED MAXIMUM TIME TO REPAIR	5 N R 2	222	
PERCENAA	REQUIRED PERCENTILE	2 N F -	286	
ACHAVAAA	REQUIRED ACHIEVED AVAILABILITY	8 N R 6	001	
INHAVAAA	REQUIRED INHERENT AVAILABILITY	8 N R 6	164	
OMAMDTAA	OPERATIONAL MEAN ACTIVE MAINTENANCE DOWNTIME	6 N R 1	223	
TMAMDTAA	TECHNICAL MEAN ACTIVE MAINTENANCE DOWNTIME	6 N R 1	223	

MIL-STD-1388-2B
APPENDIX A

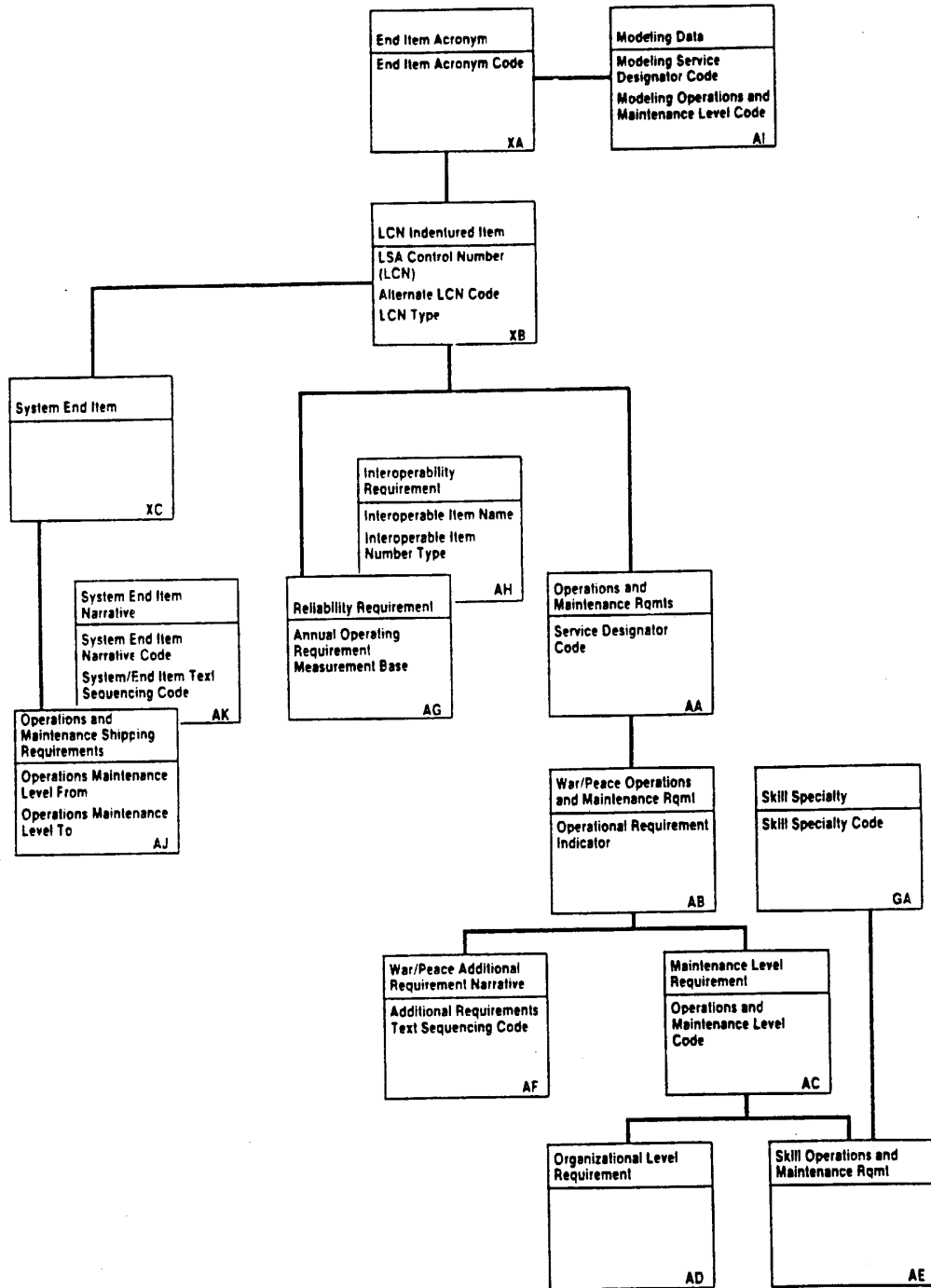

MIL-STD-1388-2B
APPENDIX A

OPMTTRAA	REQUIRED OPERATIONAL MEAN TIME TO REPAIR	5 N R 2	236
TEMTTRAA	REQUIRED TECHNICAL MEAN TIME TO REPAIR	5 N R 2	236
NUOPL0AA	NUMBER OPERATING LOCATIONS	4 N R -	262
CREWSZAA	CREW SIZE	4 N R -	064
TOSYSUAA	TOTAL SYSTEMS SUPPORTED	6 N R -	454
RCMLOGAA	RELIABILITY CENTERED MAINTENANCE LOGIC UTILIZED	32 X - -	345

50.2 Table AB, War/Peace Operations and Maintenance Requirement. This table identifies O/M requirements for the new system/equipment based on its projected wartime and peacetime missions for a given service designator code. Table keys consist of EIAC (EIACODXA), LCN (LSACONXB), ALC (ALTLCNXB), LCN Type (LCNTYPXB), Service Designator Code (SERDESAA), and Operational Requirement Indicator (OPRQINAB). For a given row, Mean Mission Duration (MMISDUAB) and Mean Mission Duration Measurement Base (MMISDMAB) must either both be blank, or have entries.

<u>CODE</u>	<u>DATA ELEMENT TITLE</u>	<u>FORMAT</u>	<u>DED</u>	<u>KEY</u>
EIACODXA	END ITEM ACRONYM CODE	10 X L -	096	F
LSACONXB	LSA CONTROL NUMBER (LCN)	18 X L -	199	F
ALTLCNXB	ALTERNATE LCN CODE	2 N F -	019	F
LCNTYPXB	LCN TYPE	1 A F -	203	F
SERDESAA	SERVICE DESIGNATOR CODE	1 A F -	376	F
OPRQINAB	OPERATIONAL REQUIREMENT INDICATOR	1 A F -	275	K
ANNOMIAB	ANNUAL NUMBER OF MISSIONS	6 N R -	021	
ANOPDAAB	ANNUAL OPERATING DAYS	3 N R -	022	
ANOPTIAB	ANNUAL OPERATING TIME	4 N R -	024	
MMISDUAB	MEAN MISSION DURATION	6 N R 1	228	
MMISDMAB	MEAN MISSION DURATION MEASUREMENT BASE	1 A F -	238	
OPAVAIAB	REQUIRED OPERATIONAL AVAILABILITY	8 N R 6	273	
OPALDTAB	REQUIRED ADMINISTRATIVE AND LOGISTIC DELAY TIME	3 N R -	013	
OSTBTIAB	REQUIRED STANDBY TIME	4 N R -	403	

50.3 Table AC, Maintenance Level Requirement. This table identifies O/M requirements for the new system/equipment by O/M level, wartime/peacetime scenario, and service designator code. Table keys consist of EIAC (EIACODXA), LCN (LSACONXB), ALC (ALTLCNXB), LCN Type (LCNTYPXB), Service Designator Code (SERDESAA), Operational Requirement Indicator (OPRQINAB), and O/M Level Code (OMLVLCAC). For a given row, Maintenance Level Percentile (MLPERCAC) is not allowed without a Maintenance Level Maximum Time to Repair (MLMTTRAC).

<u>CODE</u>	<u>DATA ELEMENT TITLE</u>	<u>FORMAT</u>	<u>DED</u>	<u>KEY</u>
EIACODXA	END ITEM ACRONYM CODE	10 X L -	096	F
LSACONXB	LSA CONTROL NUMBER (LCN)	18 X L -	199	F
ALTLCNXB	ALTERNATE LCN CODE	2 N F -	019	F
LCNTYPXB	LCN TYPE	1 A F -	203	F
SERDESAA	SERVICE DESIGNATOR CODE	1 A F -	376	F
OPRQINAB	OPERATIONAL REQUIREMENT	1 A F -	275	F

MIL-STD-1388-2B
APPENDIX A

	INDICATOR				
OMLVLCAC	OPERATIONS AND MAINTENANCE LEVEL CODE	1 A F -	277		K
MLMTTRAC	MAINTENANCE LEVEL MAXIMUM TIME TO REPAIR	5 N R 2	222		
MLPERCAC	MAINTENANCE LEVEL PERCENTILE	2 N F -	286		
MLNSSUAC	NUMBER OF SYSTEMS SUPPORTED	6 N R -	265		
MLSAMHAC	MAINTENANCE LEVEL SCHEDULED ANNUAL MAN-HOURS	6 N R 1	020		
MLUAMHAC	MAINTENANCE LEVEL UNSCHEDULED ANNUAL MAN-HOURS	6 N R 1	020		
MLSMHOAC	SCHEDULED MAN-HOUR PER OPERATING HOUR	8 N R 5	215		
MLUMHOAC	UNSCHEDULED MAN-HOUR PER OPERATING HOUR	8 N R 5	215		
MLUMETAC	UNSCHEDULED MAINTENANCE MEAN ELAPSED TIME	5 N R 2	499		
MLUMMHAC	UNSCHEDULED MAINTENANCE MEAN MAN-HOURS	5 N R 2	499		

50.4 Table AD, Organizational Level Requirement. This table identifies organizational level O/M requirements for the new system/equipment by wartime/peacetime scenario, O/M level, and service designator code. Table keys consist of EIAC (EIACODXA), LCN (LSACONXB), ALC (ALTLCNXB), LCN Type (LCNTYPXB), Service Designator Code (SERDESAA), Operational Requirement Indicator (OPRQINAB), and O/M Level Code (OMLVLCAC). For a given row, only "C" and "O" for the O/M Level Code (OMLVLCAC) are allowed for this table.

<u>CODE</u>	<u>DATA ELEMENT TITLE</u>	<u>FORMAT</u>	<u>DED</u>	<u>KEY</u>
EIACODXA	END ITEM ACRONYM CODE	10 X L -	096	F
LSACONXB	LSA CONTROL NUMBER (LCN)	18 X L -	199	F
ALTLCNXB	ALTERNATE LCN CODE	2 N F -	019	F
LCNTYPXB	LCN TYPE	1 A F -	203	F
SERDESAA	SERVICE DESIGNATOR CODE	1 A F -	376	F
OPRQINAB	OPERATIONAL REQUIREMENT INDICATOR	1 A F -	275	F
OMLVLCAC	OPERATIONS AND MAINTENANCE LEVEL CODE	1 A F -	277	F
DINMETAD	DAILY INSPECTION MEAN ELAPSED TIME	5 N R 2	280	
DINMMHAD	DAILY INSPECTION MEAN MAN-HOURS	5 N R 2	280	
PREMETAD	PREOPERATIVE INSPECTION MEAN ELAPSED TIME	5 N R 2	280	
PREMMHAD	PREOPERATIVE INSPECTION MEAN MAN-HOURS	5 N R 2	280	
POIMETAD	POST OPERATIVE INSPECTION MEAN ELAPSED TIME	5 N R 2	280	
POIMMHAD	POST OPERATIVE INSPECTION MEAN MAN-HOURS	5 N R 2	280	
PINMETAD	PERIODIC INSPECTION MEAN ELAPSED TIME	5 N R 2	280	
PINMMHAD	PERIODIC INSPECTION MEAN MAN-HOURS	5 N R 2	280	
MPCMETAD	MISSION PROFILE CHANGE MEAN	5 N R 2	280	

MIL-STD-1388-2B
APPENDIX A

	ELAPSED TIME			
MPCMMHAD	MISSION PROFILE CHANGE MEAN MAN-HOURS	5 N R 2	280	
TINMETAD	TURNAROUND INSPECTION MEAN ELAPSED TIME	5 N R 2	280	
TINMMHAD	TURNAROUND INSPECTION MEAN MAN-HOURS	5 N R 2	280	

50.5 Table AE, Skill Operations and Maintenance Requirement. This table identifies operational maintenance manpower constraints by SSC at specific O/M levels given a wartime/peacetime scenario and service designator code. Table keys consist of EIAC (EIACODXA), LCN (LSACONXB), ALC (ALTLCNXB), LCN Type (LCNTYPXB), Service Designator Code (SERDESAA), Operational Requirement Indicator (OPRQINAB), O/M Level Code (OMLVLCAL), and SSC (SKSPCDGA).

<u>CODE</u>	<u>DATA ELEMENT TITLE</u>	<u>FORMAT</u>	<u>DED</u>	<u>KEY</u>
EIACODXA	END ITEM ACRONYM CODE	10 X L -	096	F
LSACONXB	LSA CONTROL NUMBER (LCN)	18 X L -	199	F
ALTLCNXB	ALTERNATE LCN CODE	2 N F -	019	F
LCNTYPXB	LCN TYPE	1 A F -	203	F
SERDESAA	SERVICE DESIGNATOR CODE	1 A F -	376	F
OPRQINAB	OPERATIONAL REQUIREMENT INDICATOR	1 A F -	275	F
OMLVLCAC	OPERATIONS AND MAINTENANCE LEVEL CODE	1 A F -	277	F
SKSPCDGA	SKILL SPECIALTY CODE	7 X L -	387	F
AVAIMHAE	AVAILABLE MAN HOUR	6 N R -	028	
QTYAVAAE	AVAILABLE QUANTITY	5 N R -	324	
UTRATIAE	UTILIZATION RATIO	3 N R 2	503	

50.6 Table AF, War/Peace Additional Requirements Narrative. This is a narrative table which identifies the additional O/M requirements for the new system/equipment by wartime/peacetime and service designator code. Table keys consist of EIAC (EIACODXA), LCN (LSACONXB), ALC (ALTLCNXB), LCN Type (LCNTYPXB), Service Designator Code (SERDESAA), Operational Requirement Indicator (OPRQINAB), and Additional Requirements Text Sequencing Code (TEXSEQAF).

<u>CODE</u>	<u>DATA ELEMENT TITLE</u>	<u>FORMAT</u>	<u>DED</u>	<u>KEY</u>
EIACODXA	END ITEM ACRONYM CODE	10 X L -	096	F
LSACONXB	LSA CONTROL NUMBER (LCN)	18 X L -	199	F
ALTLCNXB	ALTERNATE LCN CODE	2 N F -	019	F
LCNTYPXB	LCN TYPE	1 A F -	203	F
SERDESAA	SERVICE DESIGNATOR CODE	1 A F -	376	F
OPRQINAB	OPERATIONAL REQUIREMENT INDICATOR	1 A F -	275	F
TEXSEQAF	ADDITIONAL REQUIREMENTS TEXT SEQUENCING CODE	5 N R -	450	K
WPADDRAF	ADDITIONAL REQUIREMENTS	65 X - -	009	

50.7 Table AG, Reliability Requirement. This table identifies reliability requirement parameters for the new system/equipment that are dependent on

MIL-STD-1388-2B
APPENDIX A

measurement base (MB). There can be multiple tables depending upon the annual operating requirements (AOR) MB. Table keys consist of EIAC (EIACODXA), LCN (LSACONXB), ALC (ALTLCNXB), LCN Type (LCNTYPXB), and AOR MB (MEASBSAG). For a given row of information, the following cross-element edits apply to table AG:

a. AOR (ANOPREAG) and AOR MB (MEASBSAG) must either both be blank, or have entries.

b. Reliability Operational Requirements Indicator (OPRQINAG) must match Operational Requirements Indicator (OPRQINAB) in Table AB for the given keys. The keys consist of EIAC (EIACODXA), LCN (LSACONXB), ALC (ALTLCNXB), and LCN Type (LCNTYPXB).

<u>CODE</u>	<u>DATA ELEMENT TITLE</u>	<u>FORMAT</u>	<u>DED</u>	<u>KEY</u>
EIACODXA	END ITEM ACRONYM CODE	10 X L -	096	F
LSACONXB	LSA CONTROL NUMBER (LCN)	18 X L -	199	F
ALTLCNXB	ALTERNATE LCN CODE	2 N F -	019	F
LCNTYPXB	LCN TYPE	1 A F -	203	F
MEASBSAG	ANNUAL OPERATING REQUIREMENT MEASUREMENT BASE	1 A F -	238	K
ANOPREAG	ANNUAL OPERATING REQUIREMENT	6 N R -	023	M
OPRQINAG	RELIABILITY OPERATIONAL REQUIREMENTS INDICATOR	1 A F -	275	M
OPMTBFAG	REQUIRED OPERATIONAL MEAN TIME BETWEEN FAILURES	10 D - -	229	
TEMTBFAG	REQUIRED TECHNICAL MEAN TIME BETWEEN FAILURES	10 D - -	229	
OPMRBMAG	REQUIRED OPERATIONAL MEAN TIME BETWEEN MAINTENANCE ACTIONS	10 D - -	230	
TMTBMAAG	REQUIRED TECHNICAL MEAN TIME BETWEEN MAINTENANCE ACTIONS	10 D - -	230	
MTBRXXAG	REQUIRED MEAN TIME BETWEEN REMOVALS	10 D - -	235	

50.8 Table AH, Interoperability Requirement. This table identifies item name, national stock number (NSN), and the TM of the system/equipment with which the new system/equipment must be able to be transported by/interoperate with. Table keys consist of EIAC (EIACODXA), LCN (LSACONXB), ALC (ALTLCNXB), LCN Type (LCNTYPXB), Interoperable Item Name (IONAMEAH), and Interoperable Item Number Type (IOINTYAH). For a given row of information, the following cross-element edits apply to table AH:

a. Interoperable CAGE Number (IOCAGEAH) and Interoperable Reference Number (IOREFNAH) must either both be blank, or both have entries.

b. Interoperable Item National Item Identification Number (IONIINAH) and Interoperable Item NSN Federal Supply Classification (IONFSCAH) must either both be blank, or both have entries.

<u>CODE</u>	<u>DATA ELEMENT TITLE</u>	<u>FORMAT</u>	<u>DED</u>	<u>KEY</u>
EIACODXA	END ITEM ACRONYM CODE	10 X F -	096	F
LSACONXB	LSA CONTROL NUMBER (LCN)	18 X L -	199	F
ALTLCNXB	ALTERNATE LCN CODE	2 N F -	019	F
LCNTYPXB	LCN TYPE	1 A F -	203	F

MIL-STD-1388-2B
APPENDIX A

IONAMEAH	INTEROPERABLE ITEM NAME	19 X L -	182	K
IOINTYAH	INTEROPERABLE ITEM NUMBER TYPE	1 A F -	266	K
IOCAGEAH	INTEROPERABLE CAGE CODE	5 X F -	046	
IOREFNAH	INTEROPERABLE REFERENCE NUMBER	32 X L -	337	
IONIINAH	INTEROPERABLE ITEM NATIONAL ITEM IDENTIFICATION NUMBER	9 N F -	253	
IONFSCAH	INTEROPERABLE ITEM NATIONAL STOCK NUMBER FEDERAL SUPPLY CLASSIFICATION	4 N F -	253	
IOITNMAH	INTEROPERABLE ITEM TECHNICAL MANUAL NUMBER	30 X L -	440	

50.9 Table AI, Modeling Data. This table documents maintenance level specific information, for a given service designator code, to be used for LSA modeling. Table keys consist of EIAC (EIACODXA), Modeling Service Designator Code (SERDESAA), and Modeling O/M Level Code (OMLVLAI).

<u>CODE</u>	<u>DATA ELEMENT TITLE</u>	<u>FORMAT</u>	<u>DED</u>	<u>KEY</u>
EIACODXA	END ITEM ACRONYM CODE	10 X F -	096	F
SERDESAI	MODELING SERVICE DESIGNATOR CODE	1 A F -	376	K
OMLVLCAI	MODELING OPERATIONS AND MAINTENANCE LEVEL CODE	1 A F -	277	K
LABRATAI	LABOR RATE	4 N R 2	189	
NOSHPSAI	NUMBER OF SHOPS	2 N R -	263	
RPWSCSAI	REPAIR WORK SPACE COST	4 N R 2	352	
RQDSTKAI	REQUIRED DAYS OF STOCK	3 N R -	357	

50.10 Table AJ, Operations and Maintenance Shipping Requirement. This table identifies the O/M level from which a spare/repair part is shipped and the O/M level which receives the part. Table keys consist of EIAC (EIACODXA), LCN (LSACONXB), ALC (ALTLCNXB), LCN Type (LCNTYPXB), O/M Level From (OMLVLFAJ), O/M Level To (OMLVLTAJ).

<u>CODE</u>	<u>DATA ELEMENT TITLE</u>	<u>FORMAT</u>	<u>DED</u>	<u>KEY</u>
EIACODXA	END ITEM ACRONYM CODE	10 X L -	096	F
LSACONXB	LSA CONTROL NUMBER (LCN)	18 X L -	199	F
ALTLCNXB	ALTERNATE LCN CODE	2 N F -	019	F
LCNTYPXB	LCN TYPE	1 A F -	203	F
OMLVLFAJ	OPERATIONS AND MAINTENANCE LEVEL FROM	1 A F -	277	K
OMLVLTAJ	OPERATIONS AND MAINTENANCE LEVEL TO	1 A F -	277	K
SHPDISAJ	SHIP DISTANCE	4 N R -	085	
TIMESHAJ	SHIP TIME	3 N R -	379	

50.11 Table AK, System/End Item Narrative. This table may be used to identify Additional Supportability Considerations, Additional Supportability Parameters, and Operational Mission Failure Definition. Table keys consist of EIAC (EIACODXA), LCN (LSACONXB), ALC (ALTLCNXB), LCN Type (LCNTYPXB), System/EI Narrative Code (SEINCDAK), and System/EI Narrative Text Sequencing Code (TEXSEQAK).

MIL-STD-1388-2B
APPENDIX A

a. If the System/EI Narrative Code (SEINCDAK) is (B), then this table provides a narrative description of additional supportability considerations for the item under analysis (Additional Supportability Considerations, DED 010).

b. If the System/EI Narrative Code (SEINCDAK) is (A), then this table describes additional supportability parameters which will specify data elements and associated data when discrete fields are not provided (Additional Supportability Parameters, DED 011).

c. If the System/EI Narrative Code (SEINCDAK) is (C), then this table provides a narrative of the guidelines to be followed when defining operational mission failures (Operational Mission Failure Definition, DED 274).

<u>CODE</u>	<u>DATA ELEMENT TITLE</u>	<u>FORMAT</u>	<u>DED</u>	<u>KEY</u>
EIACODXA	END ITEM ACRONYM CODE	10 X F -	096	F
LSACONXB	LSA CONTROL NUMBER (LCN)	18 X L -	199	F
ALTLCNXB	ALTERNATE LCN CODE	2 N F -	019	F
LCNTYPXB	LCN TYPE	1 A F -	203	F
SEINCDAK	SYSTEM END ITEM NARRATIVE CODE	1 A F -	424	K
TEXSEQAK	SYSTEM END ITEM NARRATIVE TEXT SEQUENCING CODE	5 N R -	450	K
SEINARAK	SYSTEM END ITEM NARRATIVE	65 X - -	---	

MIL-STD-1388-2B
APPENDIX A

60. ITEM RELIABILITY, AVAILABILITY, AND MAINTAINABILITY CHARACTERISTICS; FAILURE MODES EFFECTS AND CRITICALITY ANALYSIS; AND, MAINTAINABILITY ANALYSIS. Data tables beginning with "B" in the first position of the table code are structured to provide a description of the function of each item of the end item; outline the maintenance concept to be utilized for design and support planning purposes; and, identify any design conditions such as fail safe requirements/environmental or nuclear hardness considerations imposed upon the system. The tables summarize the item reliability, maintainability, and related availability characteristics of the item resulting from the failure modes and effects, criticality, and maintainability analyses, and accommodate a narrative description of any analysis related to the potential redesign of an item. Figure 6 depicts the relational hierarchy of these tables/entities.

<u>TABLE CODE</u>	<u>TABLE TITLE</u>
BA	Reliability, Availability, and Maintainability Characteristics
BB	Reliability, Availability, and Maintainability Characteristics Narrative
BC	Reliability, Availability, and Maintainability Logistics Considerations
BD	Reliability, Availability, and Maintainability Indicator Characteristics
BE	War/Peace Reliability, Availability, and Maintainability Indicator Characteristics
BF	Failure Mode and Reliability Centered Maintenance Analysis
BG	Failure Mode and Reliability Centered Maintenance Narrative
BH	Failure Mode Task
BI	Failure Mode Indicator Mission Phase Code Characteristics
BJ	Failure Mode Indicator Mission Phase Code Characteristics Narrative
BK	Reliability, Availability, and Maintainability Criticality
BL	Mission Phase Operational Mode

60.1 Table BA, Reliability, Availability, and Maintainability Characteristics. This table contains logistics considerations, maintenance, and reliability characteristics of the item under analysis. Table keys consist of EIAC (EIACODXA), LCN (LSACONXB), ALC (ALTLCNXB), and LCN Type (LCNTYPXB). For a given row of information, the following cross-element edits apply to table BA:

- a. The RAM area can only be used if a (Y) is entered in the RAM Indicator (RAMINDXB) Table XB.

MIL-STD-1388-2B
APPENDIX A

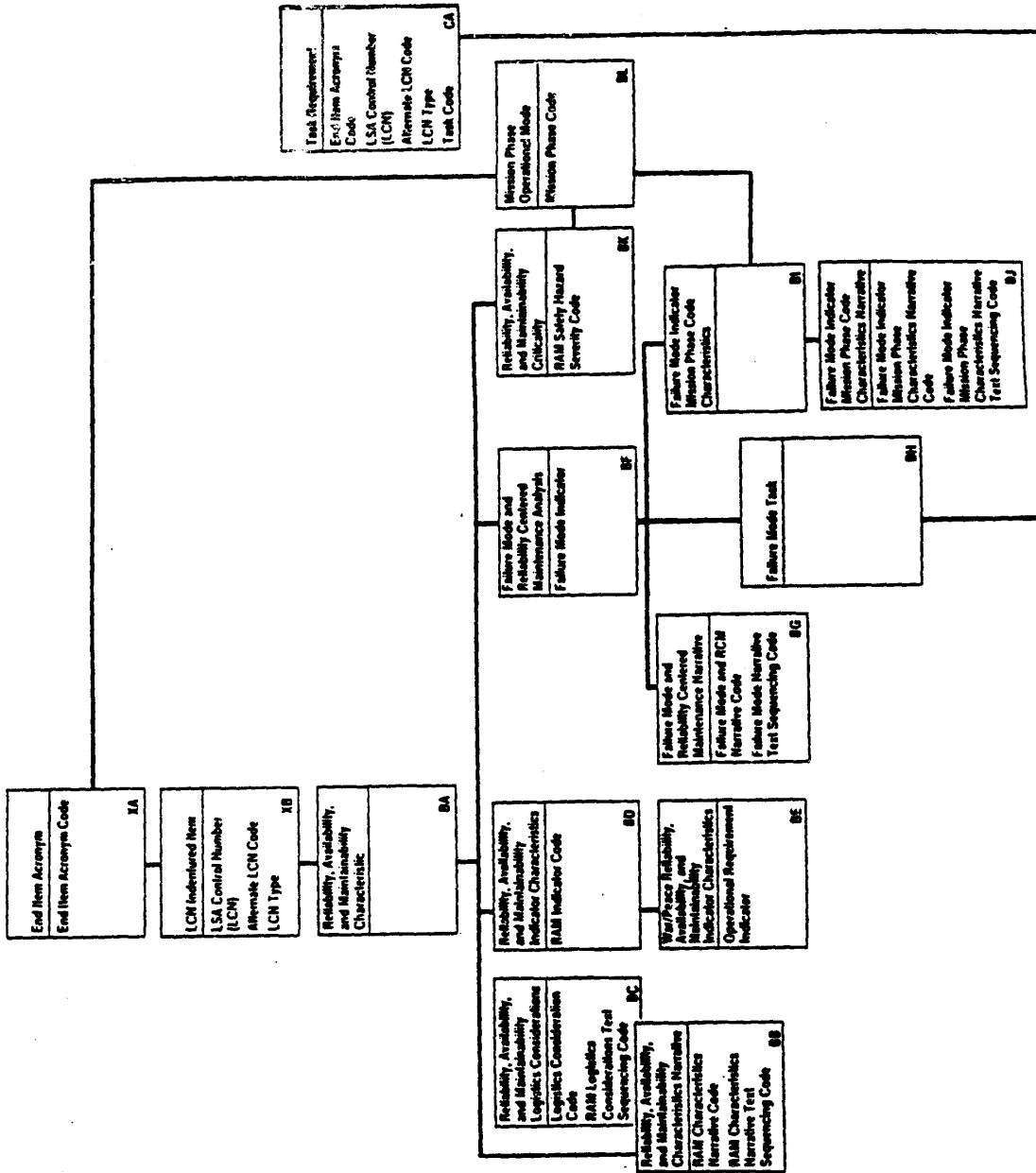

MIL-STD-1388-2B
APPENDIX A

b. Fault Isolation Percent Failure Group 1 (FIPFGABA) is not allowed without Fault Isolation Ambiguity Group 1 (FIAMBABA).

c. The combination in (b) is not allowed without Built in Test (BIT) Detection Level Percent group 1 (BDLPGABA).

d. That which applies for the combinations in Group 1 (b, c) also applies to the combination in group 2.

e. Wearout Life (WEOULIBA) and Wearout Life MB (WOLIMBBA) must either both be blank, or have entries.

<u>CODE</u>	<u>DATA ELEMENT TITLE</u>	<u>FORMAT</u>	<u>DED</u>	<u>KEY</u>
EIACODXA	END ITEM ACRONYM CODE	10 X L -	096	F
LSACONXB	LSA CONTROL NUMBER (LCN)	18 X L -	199	F
ALTLCNXB	ALTERNATE LCN CODE	2 N F -	019	F
LCNTYPXB	LCN TYPE	1 A F -	203	F
MEQLINBA	MINIMUM EQUIPMENT LIST INDICATOR	1 A F -	243	
CONVFABA	CONVERSION FACTOR	5 N - -	059	
FIAMBABA	FAULT ISOLATION AMBIGUITY GROUP 1	2 N R -	143	
FIPFGABA	FAULT ISOLATION PERCENT FAILURE GROUP 1	3 N R 1	143	
BDLPGABA	BUILT IN TEST DETECTABILITY LEVEL PERCENTAGE PER GROUP 1	2 N R -	032	
FIAMBBBA	FAULT ISOLATION AMBIGUITY GROUP 2	2 N R -	143	
FIPFGBBA	FAULT ISOLATION PERCENT FAILURE GROUP 2	3 N R 1	143	
BDLPGBBA	BUILT IN TEST DETECTABILITY LEVEL PERCENTAGE PER GROUP 2	2 N R -	032	
BITNDPBA	BUILT IN TEST CANNOT DUPLICATE PERCENTAGE	2 N R -	031	
BITROPBA	BUILT IN TEST RETEST OK PERCENT	2 N R -	033	
FRDATABA	FAILURE RATE DATA SOURCE	32 X - -	141	
PREOVCBA	PILOT REWORK OVERHAUL CANDIDATE	1 A F -	292	
SECCLEBA	SECURITY CLEARANCE	1 N F -	369	
SUPCONBA	SUPPORT CONCEPT	1 A F -	410	
WEOULIBA	WEAROUT LIFE	6 N R -	505	
WOLIMBBA	WEAROUT LIFE MEASUREMENT BASE	1 A F -	238	
LOGSTABA	LOGISTIC CONSIDERATIONS STANDARDIZATION	1 A F -	196	
LOGACCBA	LOGISTIC CONSIDERATIONS ACCESSIBILITY	1 A F -	196	
LOGMAIBA	LOGISTIC CONSIDERATIONS MAINTENANCE EASE	1 A F -	196	
LOGSAFBA	LOGISTIC CONSIDERATIONS SAFETY	1 A F -	196	
LOGTEPBA	LOGISTIC CONSIDERATIONS TEST POINTS	1 A F -	196	
LOGSKIBA	LOGISTIC CONSIDERATIONS SKILLS	1 A F -	196	
LOGTRABA	LOGISTIC CONSIDERATIONS TRAINING	1 A F -	196	
LOGCONBA	LOGISTIC CONSIDERATIONS	1 A F -	196	

MIL-STD-1388-2B
APPENDIX A

CONNECTORS				
LOGPATBA	LOGISTIC CONSIDERATIONS	1 A F -	196	
	PACKAGING AND TRANSPORTATION			
LOGFLOBA	LOGISTIC CONSIDERATION FAULT	1 A F -	196	
	LOCATION			
LOGLABBA	LOGISTIC CONSIDERATIONS	1 A F -	196	
	LABELING			
LOGDSPBA	LOGISTIC CONSIDERATIONS DESIGN	1 A F -	196	
	FOR SELF PROTECTION			
LOGCRCBA	LOGISTIC CONSIDERATIONS	1 A F -	196	
	CORROSION/RUST CONTROL			

60.2 Table BB, Reliability, Availability, and Maintainability Characteristics Narrative. This table may be used to identify RAM Item Functions, RAM Maintenance Concepts, RAM Minimum Equipment List, and RAM Qualitative and Quantitative Maintainability Requirements. Table keys consist of EIAC (EIACODXA), LCN (LSACONXB), ALC (ALTLCNXB), LCN Type (LCNTYPXB), RAM Characteristics Narrative Code (RAMCNABB), and RAM Narrative Text Sequencing Code (TEXSEQBB). For a given row of information, the following cross-element edits apply to table BE:

a. If the RAM Characteristics Narrative Code (RAMCNABB) is (A), then this table identifies the function, specification, and tolerances of the item under analysis (RAM Item Function, DED 180).

b. If the RAM Characteristics Narrative Code (RAMCNABB) is (B), then this table describes the broad, planned approach to be employed in sustaining the system/equipment at a defined level of readiness, or in a specified condition in support of the operational requirement (RAM Maintenance Concept, DED 207).

c. If the RAM Characteristics Narrative Code (RAMCNABB) is (C), then this table specifies any limitations on the end item when dispatched on its assigned mission with the item under analysis inoperative (RAM Minimum Equipment List Narrative, DED 244). RAM Minimum Equipment List Narrative (MEQLNABB) is not allowed without a (y) selected in table BA for the attribute RAM Minimum Equipment List Indicator (MEQLINBA).

d. If the RAM Characteristics Narrative Code (RAMCNABB) is (D), then this table describes the maintainability design constraints and characteristics that must be considered during the design process, to include fail safe requirements, environmental considerations, and nuclear hardened characteristics (RAM Qualitative and Quantitative Maintainability Requirements, DED 315).

e. If the RAM Characteristics Narrative Code (RAMCNABB) is (E), then this table describes the support data and analysis used in preparation of the maintenance plan (Maintenance Plan Rationale, DED 210).

<u>CODE</u>	<u>DATA ELEMENT TITLE</u>	<u>FORMAT</u>	<u>DED</u>	<u>KEY</u>
EIACODXA	END ITEM ACRONYM CODE	10 X L -	096	F
LSACONXB	LSA CONTROL NUMBER (LCN)	18 X L -	199	F
ALTLCNXB	ALTERNATE LCN CODE	2 N F -	019	F
LCNTYPXB	LCN TYPE	1 A F -	203	F

MIL-STD-1388-2B
APPENDIX A

RAMCNABB	RELIABILITY AVAILABILITY AND MAINTAINABILITY (RAM) CHARACTERISTICS NARRATIVE CODE	1 A F -	341	K
TEXSEQBB	RAM CHARACTERISTICS NARRATIVE TEXT SEQUENCING CODE	5 N R -	450	K
RAMNARBB	RAM CHARACTERISTICS NARRATIVE	65 X - -	---	

60.3 Table BC, Reliability, Availability, and Maintainability Logistics Considerations. This table contains narrative information associated with logistics considerations. Table keys consist of EIAC (EIACODXA), LCN (LSACONXB), ALC (ALTLCNXB), LCN Type (LCNTYPXB), Logistics Consideration Code (LOCOCOBC), and RAM Logistics Considerations Text Sequencing Code (TEXSEQBC).

<u>CODE</u>	<u>DATA ELEMENT TITLE</u>	<u>FORMAT</u>	<u>DED</u>	<u>KEY</u>
EIACODXA	END ITEM ACRONYM CODE	10 X L -	096	F
LSACONXB	LSA CONTROL NUMBER (LCN)	18 X L -	199	F
ALTLCNXB	ALTERNATE LCN CODE	2 N F -	019	F
LCNTYPXB	LCN TYPE	1 A F -	203	F
LOCOCOBC	LOGISTICS CONSIDERATION CODE	1 X F -	425	K
TEXSEQBC	RELIABILITY AVAILABILITY AND MAINTAINABILITY (RAM) LOGISTICS CONSIDERATIONS TEXT SEQUENCING CODE	5 N R -	450	K
LOGNARBC	RAM LOGISTICS CONSIDERATIONS	65 X - -	426	

60.4 Table BD, Reliability, Availability, and Maintainability Indicator Characteristics. This table contains reliability and maintainability characteristics of the item under analysis categorized by comparative analysis, allocated, predicted, or measured values. Table keys consist of EIAC (EIACODXA), LCN (LSACONXB), ALC (ALTLCNXB), LCN Type (LCNTYPXB), and RAM Indicator Code (RAMINDBD). For a given LCN, ALC, and LCN Type combination, each different measurement base must remain constant for all RAM Indicator Codes (RAMINDBD). For a given row of information, the following cross-element edits apply to table BD:

- a. Failure Rate (FAILRTBD) and Failure Rate MB (FARAMBBD) must either both be blank, or have entries.
- b. Percentile (PERCENBD) is not allowed without a Maximum Time to Repair (MAXTTRBD).
- c. Mean Time Between Failures Operational (OPMTBFBD) and Mean Time Between Failures Operational MB (OMTBFMBD) must either both be blank, or have entries.
- d. Mean Time Between Failures Technical (TEMTBFBD) and Mean Time Between Failures Technical MB (TMTBFMBD) must either both be blank, or have entries.
- e. Mean Time Between Maintenance Actions Operational (OMTBMABD) and Mean Time Between Maintenance Actions Operational MB (OMTBMABD) must either both be blank, or have entries.
- f. Mean Time Between Maintenance Actions Technical (TMTBMABD) and Mean Time Between Maintenance Actions Technical MB (TMTBMABD) must either both be

MIL-STD-1388-2B
APPENDIX A

blank, or have entries.

g. Mean Time Between Maintenance Induced (INMTBMBD) and Mean Time Between Maintenance Induced MB (IMTBMMBD) must either both be blank, or have entries.

h. Mean Time Between Maintenance Inherent (INHMTBBD) and Mean Time Between Maintenance Inherent MB (INHMTMBD) must either both be blank, or have entries.

i. Mean Time Between Maintenance No Defect (NOMTBMBD) and Mean Time Between Maintenance No Defect MB (NMTBMMBD) must either both be blank, or have entries.

j. Mean Time Between Preventive Maintenance (MTBMPVBD) and Mean Time Between Preventive Maintenance MB (MTBMPMBD) must either both be blank, or have entries.

k. Mean Time Between Removals (MTBRXXBD) and Mean Time Between Removals MB (MTBRMBBD) must either both be blank, or have entries.

l. Achieved Availability shall be calculated based on Mean Time Between Failure Technical (Table BD), Mean Time Between Maintenance - No Defect (Table BD), Mean Time Between Preventive Maintenance (Table BD), Elapsed Time (Table CA), and Task Frequency (CA). A change in any of these variables shall result in an update of the Achieved Availability (Table BD).

m. Inherent Availability shall be calculated based on Mean Time Between Failures Technical (Table BD) and Mean Time To Repair Technical (Table BD). A change in any of these variables shall result in an update of the Inherent Availability (Table BD).

<u>CODE</u>	<u>DATA ELEMENT TITLE</u>	<u>FORMAT</u>	<u>DED</u>	<u>KEY</u>
EIACODXA	END ITEM ACRONYM CODE	10 X L -	096	F
LSACONXB	LSA CONTROL NUMBER (LCN)	18 X L -	199	F
ALTLCNXB	ALTERNATE LCN CODE	2 N F -	019	F
LCNTYPXB	LCN TYPE	1 A F -	203	F
RAMINDBD	RAM INDICATOR CODE	1 A F -	347	K
ACHAVABD	ACHIEVED AVAILABILITY	8 N R 6	001	
INHAVABD	INHERENT AVAILABILITY	8 N R 6	164	
FAILRTBD	FAILURE RATE	10 D - -	140	
FARAMBBD	FAILURE RATE MEASUREMENT BASE	1 A F -	238	
INHMAFBD	INHERENT MAINTENANCE FACTOR	2 N R 1	165	
MAXTTRBD	MAXIMUM TIME TO REPAIR	5 N R 2	222	
PERCENBD	PERCENTILE	2 N F -	286	
MTTROPBD	MEAN TIME TO REPAIR OPERATIONAL	5 N R 2	236	
MTTRTHBD	MEAN TIME TO REPAIR TECHNICAL	5 N R 2	236	
OPMTBFBD	MEAN TIME BETWEEN FAILURES OPERATIONAL	10 D - -	229	
OMTBFMBD	MEAN TIME BETWEEN FAILURES OPERATIONAL MEASUREMENT BASE	1 A F -	238	
TEMTBFBD	MEAN TIME BETWEEN FAILURES TECHNICAL	10 D - -	229	
TMTBFMBD	MEAN TIME BETWEEN FAILURES TECHNICAL MEASUREMENT BASE	1 A F -	238	
OMTBMABD	MEAN TIME BETWEEN MAINTENANCE	10 D - -	230	

MIL-STD-1388-2B
APPENDIX A

OMTBMABD	ACTIONS OPERATIONAL MEAN TIME BETWEEN MAINTENANCE	1 A F -	238
TMTBMABD	ACTIONS OPERATIONAL MEASUREMENT BASE MEAN TIME BETWEEN MAINTENANCE	10 D - -	230
TMTBMABD	ACTIONS TECHNICAL MEAN TIME BETWEEN MAINTENANCE	1 A F -	238
INMTBMABD	ACTIONS TECHNICAL MEASUREMENT BASE MEAN TIME BETWEEN MAINTENANCE	10 D - -	231
IMTBMABD	INDUCED MEAN TIME BETWEEN MAINTENANCE	1 A F -	238
INHMTBBD	INDUCED MEASUREMENT BASE MEAN TIME BETWEEN MAINTENANCE	10 D - -	232
INHMTMBD	INHERENT MEAN TIME BETWEEN MAINTENANCE	1 A F -	238
NOMTBMABD	INHERENT MEASUREMENT BASE MEAN TIME BETWEEN MAINTENANCE	10 D - -	233
NMTBMABD	NO DEFECT MEAN TIME BETWEEN MAINTENANCE	1 A F -	238
MTBMPVBD	NO DEFECT MEASUREMENT BASE MEAN TIME BETWEEN PREVENTIVE	10 D - -	234
MTBMPMBD	MAINTENANCE MEAN TIME BETWEEN PREVENTIVE	1 A F -	238
MTBRXXBD	MAINTENANCE MEASUREMENT BASE MEAN TIME BETWEEN REMOVALS	10 D - -	235
MTBRMBBD	MEAN TIME BETWEEN REMOVALS MEASUREMENT BASE	1 A F -	238

60.5 Table BE, War/Peace Reliability, Availability, and Maintainability Indicator Characteristics. This table contains reliability and maintainability characteristics of the item under analysis categorized by wartime/peacetime scenarios and comparative, allocated, predicted, or measured values. Table keys consist of EIAC (EIACODXA), LCN (LSACONXB), ALC (ALTLCNXB), LCN Type (LCNTYPXB), RAM Indicator Code (RAMINDBD), and Operational Requirement Indicator (OPRQINBE).

<u>CODE</u>	<u>DATA ELEMENT TITLE</u>	<u>FORMAT</u>	<u>DED</u>	<u>KEY</u>
EIACODXA	END ITEM ACRONYM CODE	10 X L -	096	F
LSACONXB	LSA CONTROL NUMBER (LCN)	18 X L -	199	F
ALTLCNXB	ALTERNATE LCN CODE	2 N F -	019	F
LCNTYPXB	LCN TYPE	1 A F -	203	F
RAMINDBD	RAM INDICATOR CODE	1 A F -	347	F
OPRQINBE	RAM OPERATIONAL REQUIREMENT INDICATOR	1 A F -	275	K
ALDTXXBE	ADMINISTRATIVE AND LOGISTIC DELAY TIME	3 N R -	013	
OPAVAIBE	OPERATIONAL AVAILABILITY	8 N R 6	273	
STABYTBE	STANDBY TIME	4 N R -	403	

60.6 Table BF, Failure Mode and Reliability Centered Maintenance Analysis. This table contains failure mode information and reliability centered maintenance analysis results associated with the item under analysis failure

MIL-STD-1388-2B
APPENDIX A

modes. Table keys consist of EIAC (EIACODXA), LCN (LSACONXB), ALC (ALTLCNXB), LCN Type (LCNTYPXB), and Failure Mode Indicator (FAMOINBF). For a given row of information, the following cross-element edits apply to table BF:

a. Engineering Failure Mode Mean Time Between Failure (EFMTBFBF) and Engineering Failure Mode Mean Time Between Failure MB (EFMMBBF) must either both be blank, or have entries.

b. Engineering Failure Mode Mean Time Between Failure shall be calculated based on Failure Mode Ratio (Table BF) and Part Failure Rate (Table BD). A change in any of these variables shall result in an update of the Engineering Failure Mode Mean Time Between Failure (Table BF).

<u>CODE</u>	<u>DATA ELEMENT TITLE</u>	<u>FORMAT</u>	<u>DED</u>	<u>KEY</u>
EIACODXA	END ITEM ACRONYM CODE	10 X L -	096	F
LSACONXB	LSA CONTROL NUMBER (LCN)	18 X L -	199	F
ALTLCNXB	ALTERNATE LCN CODE	2 N F -	019	F
LCNTYPXB	LCN TYPE	1 A F -	203	F
FAMOINBF	FAILURE MODE INDICATOR	4 X F -	134	K
EFMTBFBF	ENGINEERING FAILURE MODE MEAN TIME BETWEEN FAILURE	10 D - -	097	
EFMMBBF	ENGINEERING FAILURE MODE MEAN TIME BETWEEN FAILURE MEASUREMENT BASE	1 A F -	238	
FMCLASBF	FAILURE MODE CLASSIFICATION	1 A F -	132	
FMRATOBF	FAILURE MODE RATIO	4 N R 3	136	
RCMR01BF	RELIABILITY CENTERED MAINTENANCE (RCM) LOGIC RESULTS 01	1 X F -	344	
RCMR02BF	RCM LOGIC RESULTS 02	1 X F -	344	
RCMR03BF	RCM LOGIC RESULTS 03	1 X F -	344	
RCMR04BF	RCM LOGIC RESULTS 04	1 X F -	344	
RCMR05BF	RCM LOGIC RESULTS 05	1 X F -	344	
RCMR06BF	RCM LOGIC RESULTS 06	1 X F -	344	
RCMR07BF	RCM LOGIC RESULTS 07	1 X F -	344	
RCMR08BF	RCM LOGIC RESULTS 08	1 X F -	344	
RCMR09BF	RCM LOGIC RESULTS 09	1 X F -	344	
RCMR10BF	RCM LOGIC RESULTS 10	1 X F -	344	
RCMR11BF	RCM LOGIC RESULTS 11	1 X F -	344	
RCMR12BF	RCM LOGIC RESULTS 12	1 X F -	344	
RCMR13BF	RCM LOGIC RESULTS 13	1 X F -	344	
RCMR14BF	RCM LOGIC RESULTS 14	1 X F -	344	
RCMR15BF	RCM LOGIC RESULTS 15	1 X F -	344	
RCMR16BF	RCM LOGIC RESULTS 16	1 X F -	344	
RCMR17BF	RCM LOGIC RESULTS 17	1 X F -	344	
RCMR18BF	RCM LOGIC RESULTS 18	1 X F -	344	
RCMR19BF	RCM LOGIC RESULTS 19	1 X F -	344	
RCMR20BF	RCM LOGIC RESULTS 20	1 X F -	344	
RCMR21BF	RCM LOGIC RESULTS 21	1 X F -	344	
RCMR22BF	RCM LOGIC RESULTS 22	1 X F -	344	
RCMR23BF	RCM LOGIC RESULTS 23	1 X F -	344	
RCMR24BF	RCM LOGIC RESULTS 24	1 X F -	344	
RCMR25BF	RCM LOGIC RESULTS 25	1 X F -	344	
RCMDSABF	RCM DISPOSITION A	1 X F -	084	
RCMDSBBF	RCM DISPOSITION B	1 X F -	084	

MIL-STD-1388-2B
APPENDIX A

RCMDSCBF	RCM DISPOSITION C	1 X F -	084
RCMDSDBF	RCM DISPOSITION D	1 X F -	084
RCMDSEBF	RCM DISPOSITION E	1 X F -	084
RCMDSFBF	RCM DISPOSITION F	1 X F -	084
RCMDSGBF	RCM DISPOSITION G	1 X F -	084
RCMDSHBF	RCM DISPOSITION H	1 X F -	084
RCMDSIBF	RCM DISPOSITION I	1 X F -	084
RCMDSJBF	RCM DISPOSITION J	1 X F -	084

60.7 Table BG, Failure Mode and Reliability Centered Maintenance Narrative.

This table may be used to identify Failure/Damage Mode Effect End Effect, Failure/Damage Mode Effect Local, Failure/Damage Mode Effect Next Higher, Failure Cause, Failure/Damage Mode, Failure Mode Detection Method, Failure Mode Predictability, Failure Mode Remarks, Reliability Centered Maintenance (RCM) Redesign Recommendations, and RCM Reasoning. Table keys consist of EIAC (EIACODXA), LCN (LSACONXB), ALC (ALTLCNXB), LCN Type (LCNTYPXB), Failure Mode Indicator (FAMOINBF), Failure Mode Narrative Code (FMNCNABG), and Failure Mode Narrative Text Sequencing Code (TEXSEQBG). For a given row of information, the following cross-element edits apply to table BG:

a. If the Failure Mode and RCM Narrative Code (FMNCNABG) is (A), then this table describes the consequences of each failure/damage mode end effect on the item operation, function, or status (Failure/Damage Mode Effect End Effect, DED 125).

b. If the Failure Mode and RCM Narrative Code (FMNCNABG) is (B), then this table describes the consequences of each failure/damage mode effect local on the item operation, function, or status (Failure/Damage Mode Effect Local, DED 126).

c. If the Failure Mode and RCM Narrative Code (FMNCNABG) is (C), then this table describes the consequences of each failure/damage mode effect next higher on the item operation, function, or status (Failure/Damage Mode Effect Next Higher, DED 127).

d. If the Failure Mode and RCM Narrative Code (FMNCNABG) is (D), then this table describes all possible failure causes postulated on the basis of the stated requirements in the system and failure definitions. All probable independent causes for each failure shall also be identified. (Failure Cause, DED 124).

e. If the Failure Mode and RCM Narrative Code (FMNCNABG) is (E), then this table describes all possible failure/damage mode postulated on the basis of the stated requirements in the system and failure definitions. All probable independent causes for each failure shall also be identified. A description of all possible damage modes which could result from specific threats (Failure/Damage Mode, DED 128).

f. If the Failure Mode and RCM Narrative Code (FMNCNABG) is (F), then this table describes the method(s) by which occurrence of a specific failure mode is detected by the operator or maintenance technician (Failure Mode Detection Method, DED 129).

MIL-STD-1388-2B
APPENDIX A

g. If the Failure Mode and RCM Narrative Code (FMNCNABG) is (G), then this table provides information on known incipient failure indicators which are peculiar to the item failure trends (Failure Predictability, DED 138).

h. If the Failure Mode and RCM Narrative Code (FMNCNABG) is (H), then this is a narrative table which states a condition not readily identified in a given data element. This table is related to a failure mode, therefore, it should preface with a reference to a specific failure mode (Failure Mode Remarks, DED 137).

i. If the Failure Mode and RCM Narrative Code (FMNCNABG) is (I), then this table describes recommended design changes, disposition of each recommendation, and the results of each recommendation for which analysis indicates a redesign is warranted (Redesign Recommendations, DED 426).

J. If the Failure Mode and RCM Narrative Code (FMNCNABG) is (J), then this table describes the type of age exploration and how it is to be used based on the results of the RCM analysis made in table BF (RCM Age Exploration, DED 343).

k. If the Failure Mode and RCM Narrative Code (FMNCNABG) is (K), then this table describes the reasoning behind the RCM logic results and disposition choices made in table BF (Reliability Centered Maintenance Reasoning, DED 346).

l. If the Failure Mode and RCM Narrative Code (FMNCNABG) is (L), then this table describes recommended RCM redesign changes, disposition of each recommendation, and the results of each recommendation for which analysis indicates a redesign is warranted (RCM Redesign Recommendations, DED 426).

<u>CODE</u>	<u>DATA ELEMENT TITLE</u>	<u>FORMAT</u>	<u>DED</u>	<u>KEY</u>
EIACODXA	END ITEM ACRONYM CODE	10 X L -	096	F
LSACONXB	LSA CONTROL NUMBER (LCN)	18 X L -	199	F
ALTLCNXB	ALTERNATE LCN CODE	2 N F -	019	F
LCNTYPXB	LCN TYPE	1 A F -	203	F
FAMOINBF	FAILURE MODE INDICATOR	4 X F -	134	F
FMNCNABG	FAILURE MODE AND RCM NARRATIVE CODE	1 A F -	131	K
TEXSEQBG	FAILURE MODE NARRATIVE TEXT SEQUENCING CODE	5 N R -	450	K
FMNNARBG	FAILURE MODE NARRATIVE	65 X - -	---	

60.8 Table BH, Failure Mode Task. This table identifies the maintenance task(s) that are required to correct the identified failure mode of the item under analysis and preventative maintenance tasks that deemed applicable and effective through an RCM analysis. Table keys consist of EIAC (EIACODXA), Failure Mode Task (FMT) LCN (LSACONBH), FMT ALC (ALTLCNBH), FMT LCN Type (LCNTYPBH), FMT Failure Mode Indicator (FAMOINBH), Task Requirement LCN (TLCNTYBH), Task Requirement ALC (TALCNBHC), Task Requirement LCN Type (TLCNTYBH), and Task Requirement Task Code (TTASKCBH). For a given row of information, the following cross-element edits apply to table BH:

a. The EIAC from Task Requirement Table CA and Failure Mode and RCM Analysis Table BF are the same; therefore, they are not duplicated.

MIL-STD-1388-2B
APPENDIX A

b. Table keys are migrated from table BF, but are given role name "FMT" to distinguish them (LSACONBH, ALTLCNBH, LCNTYPBH, and FAMOINBH). Table keys are migrated from table CA, but are given role name "Task Requirement" to distinguish them (TLSACNBH, TALCNCBH, TLCNTYBH, and TTASKCBH).

c. Maintenance Interval (MAININBH) and Maintenance Interval MB (MAINMBBH) must either both be blank, or have entries.

d. Edit c is not allowed unless a preventive Task Type (TATYPEBH) is selected.

e. Task Type (TATYPEBH) must be "P" or "U", if PMCS from the CA table is "Y".

<u>CODE</u>	<u>DATA ELEMENT TITLE</u>	<u>FORMAT</u>	<u>DED</u>	<u>KEY</u>
EIACODXA	END ITEM ACRONYM CODE	10 X L -	096	F
LSACONBH	FAILURE MODE TASK (FMT) LSA CONTROL NUMBER (LCN)	18 X L -	199	F
ALTLCNBH	FMT ALTERNATE LCN CODE	2 N F -	019	F
LCNTYPBH	FMT LCN TYPE	1 A F -	203	F
FAMOINBH	FMT FAILURE MODE INDICATOR	4 X F -	134	F
TLSACNBH	TASK REQUIREMENT LCN	18 X L -	199	F
TALCNCBH	TASK REQUIREMENT ALTERNATE LCN CODE	2 N F -	019	F
TLCNTYBH	TASK REQUIREMENT LCN TYPE	1 A F -	203	F
TTASKCBH	TASK CODE	7 X F -	427	F
TATYPEBH	TASK TYPE	1 A F -	433	
MAININBH	MAINTENANCE INTERVAL	10 D - -	208	
MAINMBBH	MAINTENANCE INTERVAL MEASUREMENT BASE	1 A F -	238	

60.9 Table BI, Failure Mode Indicator Mission Phase Code Characteristics.

This table contains FMECA results associated with the item under analysis categorized by failure mode and mission phase/operational mode. Table keys consist of EIAC (EIACODXA), LCN (LSACONXB), ALC (ALTLCNXB), LCN Type (LCNTYPXB), Failure Mode Indicator (FAMOINBF), and Mission Phase Code (MISSPCBL). For a given row of information, the following cross-element edits apply to table BI:

a. The EIAC from Mission Phase Operational Mode Table BL and Failure Mode Table BF are the same; therefore, they are not duplicated.

b. Operating Time (FMOPTIBI) and Operating Time MB (FMOTMBBI) must either both be blank, or have entries.

c. The Operating Time MB (FMOTMBBI) should be the same as the Failure Rate MB (FARAMBBD) from table BD for the calculations to be correct.

d. Failure Mode Criticality Number shall be calculated based on Failure Effect Probability (Table BI), Failure Mode Ratio (Table BI), Part Failure Rate (Table BD), and Operating Time (Table BI). A change in any of these variables shall result in an update of the Failure Mode Criticality Number (Table BI).

MIL-STD-1388-2B
APPENDIX A

<u>CODE</u>	<u>DATA ELEMENT TITLE</u>	<u>FORMAT</u>	<u>DED</u>	<u>KEY</u>
EIACODXA	END ITEM ACRONYM CODE	10 X L -	096	F
LSACONXB	LSA CONTROL NUMBER (LCN)	18 X L -	199	F
ALTLCNXB	ALTERNATE LCN CODE	2 N F -	019	F
LCNTYPXB	LCN TYPE	1 A F -	203	F
FAMOINBF	FAILURE MODE INDICATOR	4 X F -	134	F
MISSPCBL	MISSION PHASE CODE	1 X F -	246	F
FMSHSCBI	SAFETY HAZARD SEVERITY CODE	1 N F -	362	M
FEPROBBI	FAILURE EFFECT PROBABILITY	3 N R 2	130	
FACRNUBI	FAILURE MODE CRITICALITY NUMBER	10 D - -	133	
FPROBLBI	FAILURE PROBABILITY LEVEL	1 A F -	139	
FMOPTIBI	OPERATING TIME	6 N R 2	269	
FMOTMBBI	OPERATING TIME MEASUREMENT BASE	1 A F -	238	

60.10 Table BJ, Failure Mode Indicator Mission Phase Code Characteristics Narrative. This table may be used to identify Compensating Design Provisions and Compensating Operator Actions. Table keys consist of EIAC (EIACODXA), LCN (LSACONXB), ALC (ALTLCNXB), LCN Type (LCNTYPXB), Failure Mode Indicator (FAMOINBF), Mission Phase Code (MISSPCBL), Failure Mode Indicator Mission Phase Characteristics Narrative Code (FMMPCNBJ), and Failure Mode Indicator Mission Phase Code Characteristics Narrative Text Sequencing Code (TEXSEQBH). For a given row of information, the following cross-element edits apply to table BJ:

a. If the Failure Mode Indicator Mission Phase Characteristics Narrative Code (FMMPCNBJ) is (A), then this table describes compensating design provisions which circumvent or mitigate the effect of the failure (Compensating Design Provisions, DED 049).

b. If the Failure Mode Indicator Mission Phase Characteristics Narrative Code (FMMPCNBJ) is (B), then this table describes compensating operator action provisions which circumvent or mitigate the effect of the failure (Compensating Operator Action Provisions, DED 050).

<u>CODE</u>	<u>DATA ELEMENT TITLE</u>	<u>FORMAT</u>	<u>DED</u>	<u>KEY</u>
EIACODXA	END ITEM ACRONYM CODE	10 X L -	096	F
LSACONXB	LSA CONTROL NUMBER (LCN)	18 X L -	199	F
ALTLCNXB	ALTERNATE LCN CODE	2 N F -	019	F
LCNTYPXB	LCN TYPE	1 A F -	203	F
FAMOINBF	FAILURE MODE INDICATOR	4 X F -	134	F
MISSPCBL	MISSION PHASE CODE	1 X F -	246	F
FMMPCNBJ	FAILURE MODE INDICATOR MISSION PHASE CHARACTERISTICS NARRATIVE CODE	1 A F -	135	K
TEXSEQBJ	FAILURE MODE INDICATOR MISSION PHASE CHARACTERISTICS NARRATIVE TEXT SEQUENCING CODE	5 N R -	450	K
FMCNARBJ	FAILURE MODE INDICATOR MISSION PHASE CHARACTERISTICS NARRATIVE	65 X - -	---	

60.11 Table BK, Reliability, Availability, and Maintainability Criticality. This table sums up the failure mode criticality numbers related to the failure modes of an item within specific safety hazard severity classification (SHSC)

MIL-STD-1388-2B
APPENDIX A

and mission phases. Table keys consist of EIAC (EIACODXA), LCN (LSACONXB), ALC (ALTLCNXB), LCN Type (LCNTYPXB), Mission Phase Code (MISSPCBL), and RAM SHSC (FMSHSCBC).

a. Item Criticality Number shall be calculated based on the summation of the Failure Mode Criticality Numbers (Table BI).

b. A change in any of the Failure Mode Criticality Numbers (Table BI) shall result in an update of the Item Criticality Number (Table BK).

c. Safety Hazard Severity Code (BI.FMSHSCBI) must be established in table BI prior to establishing a RAM Safety Hazard Severity Code (BK.FMSHSCBK) in this table.

<u>CODE</u>	<u>DATA ELEMENT TITLE</u>	<u>FORMAT</u>	<u>DED</u>	<u>KEY</u>
EIACODXA	END ITEM ACRONYM CODE	10 X L -	096	F
LSACONXB	LSA CONTROL NUMBER (LCN)	18 X L -	199	F
ALTLCNXB	ALTERNATE LCN CODE	2 N F -	019	F
LCNTYPXB	LCN TYPE	1 A F -	203	F
MISSPCBL	MISSION PHASE CODE	1 X F -	246	F
FMSHSCBK	RAM SAFETY HAZARD SEVERITY CODE	1 N F -	362	K
RICRITBK	RAM ITEM CRITICALITY NUMBER	10 D - -	178	

60.12 Table BL, Mission Phase Operational Mode. This table identifies the mission phase/operational modes that the new system/equipment is expected to experience during normal operation. Table keys consist of EIAC (EIACODXA) and Mission Phase Code (MISSPCBL).

<u>CODE</u>	<u>DATA ELEMENT TITLE</u>	<u>FORMAT</u>	<u>DED</u>	<u>KEY</u>
EIACODXA	END ITEM ACRONYM CODE	10 X L -	096	F
MISSPCBL	MISSION PHASE CODE	1 X F -	246	K
MPOPLDBL	MISSION PHASE OPERATIONAL MODE	65 X - -	247	

MIL-STD-1388-2B
APPENDIX A

70. TASK INVENTORY, TASK ANALYSIS, PERSONNEL AND SUPPORT REQUIREMENTS. The following data tables identified by a "C" in the first position of the table code are required for documentation of task analysis and personnel and support requirement data. These tables equate to MIL-STD-1388-2A "C" and "D" records. Information will be presented in sufficient detail to define task times, skills, tools, support equipment, facilities, and supply support requirements. The task taxonomy utilized to analyze and inventory tasks is located in the glossary of MIL-STD-1388-1, Notice 3 and DED 372 of this standard. Figure 7 depicts the entity diagram for these tables.

<u>TABLE CODE</u>	<u>TABLE TITLE</u>
CA	Task Requirement
CB	Subtask Requirement
CC	Sequential Subtask Description
CD	Subtask Personnel Requirement
CE	Task Remark
CF	Task Remark Reference
CG	Task Support Equipment
CH	Task Manual
CI	Task Provisioned Item
CJ	Job and Duty Assignments
CK	Task Inventory

70.1 Table CA, Task Requirement. This table contains task level information such as Mean Elapsed Time, Task Frequency, Task Criticality, Task Identification (ID) and Task Code. It also contains information about personnel and training aspects of the task. In addition, this table provides the capability to reference an entire task. Table keys consist of LCN (LSACONXB), LCN Type (LCNTYPXB), ALC (ALTLCNXB), EIAC (EIACODXA), and Task Code (TASKCDCA).

a. For referencing purposes only, Referenced LCN (REFLCNCA), Referenced LCN Type (REFTYPCA), Referenced ALC (REFALCCA), Referenced EIAC (REFEIACA), and Referenced Task Code (REFTSKCA) are mandatory keys. This referencing capability should only be used when the data of this table and the subordinate tables (tables CB through CI) are the same for referenced and referencing tasks. All non-mandatory attributes in Table CA and all subordinate tables (Tables CB - CI) are pulled from the Referenced Task and it's subordinate tables. Key attributes entered in Table CA will migrate to all subordinate tables; but, additional keys which are needed in subordinate tables will be pulled from the Referenced Task and it's subordinate tables. In other words, only key entries and referenced entries are required in this table and no further entries are required in subordinate tables.

MIL-STD-1388-2B
APPENDIX A

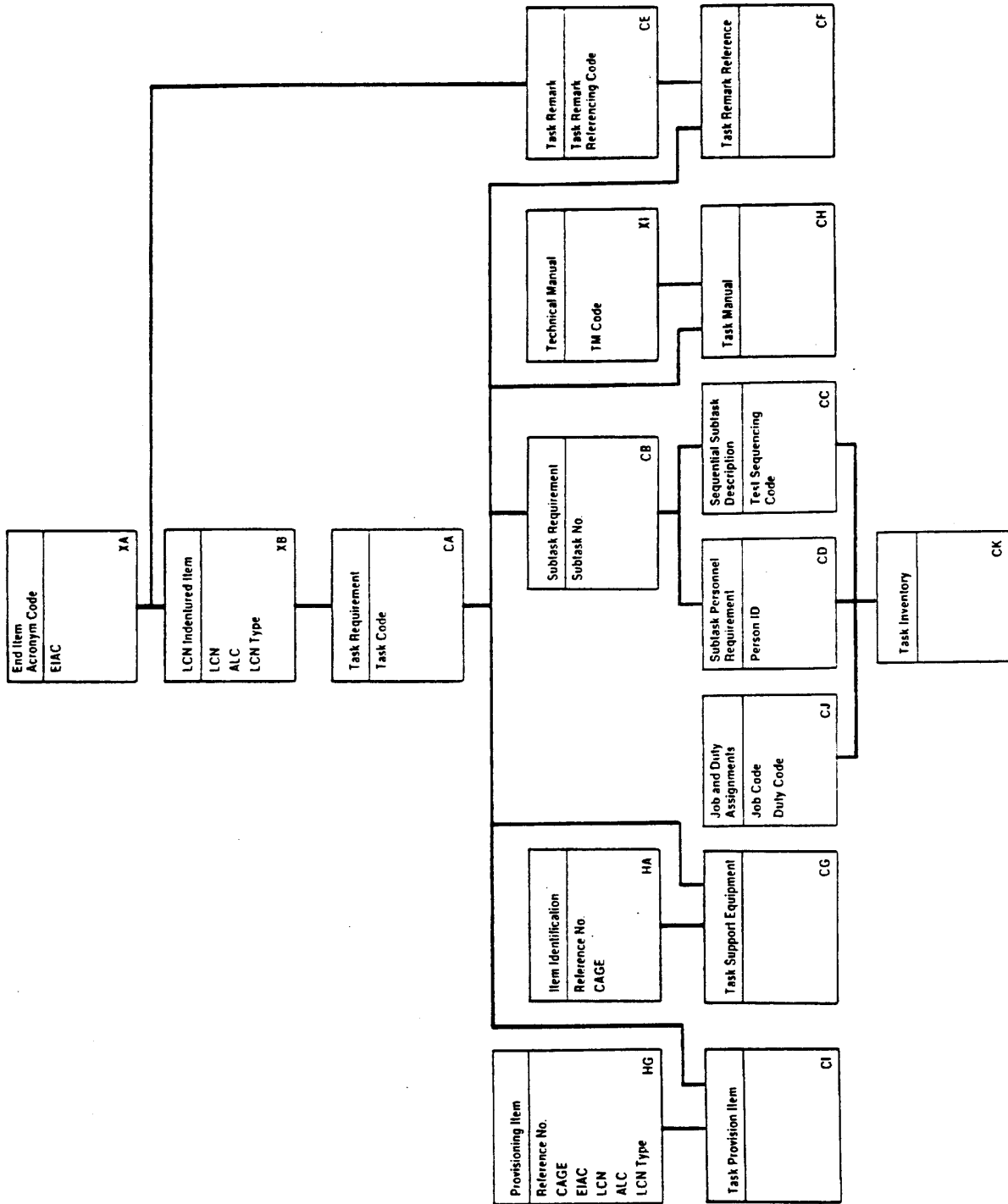

MIL-STD-1388-2B
APPENDIX A

b. Unscheduled task codes, task interval codes of "F", "G", or "J" (2d position of the task code), must have an MB entered which corresponds to the MB for the AOR. For this reason, the AOR LCN (AORLCNCA), AOR ALC (AORALCCA), AOR LCN Type (AORTYPCA), and the AOR MB (AORMSBCA) must match with a set of key values already established in Table AG.

c. Every Task Code (TASKCDCA) must have a Task ID (TASKIDCA).

d. Secondary Means of Detection (SMDTECCA) is not allowed without Primary Means of Detection (PMDTECCA).

e. Up to three Performance Standards (PRSTDACA, PRSTDBCA, PRSTDCCA) and Task Conditions (TCONDACA, TCONDBCA, TCONDCCA) can be entered for a given record.

f. Every task code requires a corresponding task frequency.

g. If the Facility Requirement Code (FTRNRQCA) is "Y", the Facility tables (F tables) should be addressed.

h. Up to four Training Location Rationale (TRNLOCCA) codes may be entered for each unique combination of LCN, EIAC, ALC, LCN Type, and task code (codes must be entered in a continuous string).

i. Up to four Training Rationale (TRNRATCA) codes may be entered for each unique combination of LCN, EIAC, ALC, LCN Type and task code (codes must be entered in a continuous string).

j. Measured Mean Man-Hours (MSDMMHCA) are calculated by summing the Mean Man-Minutes (SUBMMMCD) per Person ID for the given task (see DED 225) and dividing by 60.

k. Measured Mean Elapsed Time (MSDMETCA) is calculated by summing the Mean Minute Elapsed Times (SBMMETCB) for all subtasks of a task (see DED 225) and dividing by 60.

l. Task Frequency (corrective) shall be calculated based on Failure Mode Ratio (Table BF), Failure Rate (Table BD), Mean Time Between Maintenance Induced (Table BD), Mean Time Between Maintenance No Defect (Table BD), Conversion Factor (Table BA), and Annual Operating Requirements (Table AG). Task Frequency (preventive) shall be calculated based on Annual Operating Requirements (Table AG), Conversion Factor (Table BA), Maintenance Interval (Table BH), or Task Interval Code (Table CA). A change in any of these variables shall result in an update of Task Frequency (Table CA).

<u>CODE</u>	<u>DATA ELEMENT TITLE</u>	<u>FORMAT</u>	<u>DED</u>	<u>KEY</u>
EIACODXA	END ITEM ACRONYM CODE	10 X L -	096	F
LSACONXB	LSA CONTROL NUMBER (LCN)	18 X L -	199	F
ALTLCNXB	ALTERNATE LCN CODE	2 N F -	019	F
LCNTYPXB	LCN TYPE	1 A F -	203	F
TASKCDCA	TASK CODE	7 X F -	427	K
REFEIACA	REFERENCED END ITEM ACRONYM CODE	10 X L -	096	

MIL-STD-1388-2B
APPENDIX A

REFLCNCA	REFERENCED LCN	18 X L -	199	
REFALCCA	REFERENCED ALTERNATE LCN CODE	2 X L -	019	
REFTYPCA	REFERENCED LCN TYPE	1 A F -	203	
REFTSKCA	REFERENCED TASK CODE	7 X F -	427	
AORLCNCA	ANNUAL OPERATING REQUIREMENT (AOR) LCN	18 X L -	199	
AORALCCA	AOR ALC	2 N F -	019	
AORTYPCA	AOR LCN TYPE	1 A F -	203	
AORMSBCA	TASK AOR MEASUREMENT BASE	1 A F -	238	
TASKIDCA	TASK IDENTIFICATION	36 X L -	431	M
TSKFRQCA	TASK FREQUENCY	7 N R 4	430	
TSKCRCCA	TASK CRITICALITY CODE	1 A F -	429	
HRDCPCCA	HARDNESS CRITICAL PROCEDURE CODE	1 A F -	152	
HAZMPCCA	HAZARDOUS MAINTENANCE PROCEDURES CODE	1 A F -	155	
PMCSIDCA	PREVENTIVE MAINTENANCE CHECKS AND SERVICES INDICATOR CODE	1 A F -	296	
MSDMETCA	MEASURED MEAN ELAPSED TIME	5 N R 2	224	
PRDMETCA	PREDICTED MEAN ELAPSED TIME	5 N R 2	224	
MSDMMHCA	MEASURED MEAN MAN HOURS	5 N R 2	225	
PRDMMHCA	PREDICTED MEAN MAN HOURS	5 N R 2	225	
PMDTECCA	PRIMARY MEANS OF DETECTION	1 A F -	237	
SMDTECCA	SECONDARY MEANS OF DETECTION	1 A F -	237	
FTRNRQCA	FACILITY REQUIREMENT CODE	1 A F -	358	
TRNRQCCA	TRAINING EQUIPMENT REQUIREMENT CODE	1 A F -	358	
TRNRECCA	TRAINING RECOMMENDATION TYPE	1 A F -	463	
TRNLOCCA	TRAINING LOCATION RATIONALE	4 A L -	461	
TRNRATCA	TRAINING RATIONALE	4 A L -	462	
TSEREQCA	TOOL/SUPPORT EQUIPMENT REQUIREMENT CODE	1 A F -	358	
PRSTDACA	TASK PERFORMANCE STANDARD A	1 A F -	287	
PRSTDBCA	TASK PERFORMANCE STANDARD B	1 A F -	287	
PRSTDCCA	TASK PERFORMANCE STANDARD C	1 A F -	287	
TCONDACA	TASK CONDITION A	1 A F -	428	
TCONDBCA	TASK CONDITION B	1 A F -	428	
TCONDCCA	TASK CONDITION C	1 A F -	428	

70.2 Table CB, Subtask Requirement. This table contains data related to the subtask level such as Work Area Code and Mean Minute Elapsed Time. All task narrative will be written at the subtask level, then rolled into the task level. It is possible to reference subtask descriptions within this table. Table keys consist of LCN (LSACONXB), LCN Type (LCNTYPXB), ALC (ALTLCNXB), EIAC (EIACODXA), Task Code (TASKCDCA), and Subtask Number (SUBNUMCB).

a. For referencing purposes, Referenced Subtask Number (RFDSUBCB), Referenced Subtask Task Code (RFDTCDCEB), Referenced Subtask LCN (RFDLCNCB), Referenced Subtask ALC (RFDALCCB), Referenced Subtask LCN Type (RFDALCCB), and Referenced Subtask EIAC (RFDEIACB) must be included as nonidentifying keys. This referencing capability should only be used when the data of this table and the subordinate tables SEQUENTIAL TASK DESCRIPTION and SUBTASK PERSONNEL REQUIREMENTS (tables CC and CD) are the same for referenced and referencing subtasks. All non-key attributes in table CB and its subordinate tables (CC and CD) are pulled from the referenced subtask and its subordinate tables.

MIL-STD-1388-2B
APPENDIX A

Keys from table CB migrate down to tables CC and CD. Additional keys needed for tables CC and CD are pulled from referenced subtask tables CC and CD.

b. Subtask Numbers shall begin with 001 and run through 999 for each unique set of keys (e.g., EIAC, LCN, ALC, LCN Type, and task code). Skips are allowed when assigning subtask numbers.

<u>CODE</u>	<u>DATA ELEMENT TITLE</u>	<u>FORMAT</u>	<u>DED</u>	<u>KEY</u>
EIACODXA	END ITEM ACRONYM CODE	10 X L -	096	F
LSACONXB	LSA CONTROL NUMBER (LCN)	18 X L -	199	F
ALTLCNXB	ALTERNATE LCN CODE	2 N F -	019	F
LCNTYPXB	LCN TYPE	1 A F -	203	F
TASKCDCA	TASK CODE	7 X F -	427	F
SUBNUMCB	SUBTASK NUMBER	3 N F -	407	K
SUBTIDCB	SUBTASK IDENTIFICATION	36 X L -	431	
RFDEIACB	REFERENCED SUBTASK END ITEM ACRONYM CODE	10 X L -	096	
RFDLNCNB	REFERENCED SUBTASK LCN	18 X L -	199	
RFDALCCB	REFERENCED SUBTASK ALTERNATE LCN CODE	2 N F -	019	
RFDTYPCB	REFERENCED SUBTASK LCN TYPE	1 A F -	203	
RFDTDCB	REFERENCED SUBTASK TASK CODE	7 X F -	427	
RFDSUBCB	REFERENCED SUBTASK NUMBER	3 N F -	407	
SBMMETCB	SUBTASK MEAN MINUTE ELAPSE TIME	5 N R 1	227	
SUBWACCB	SUBTASK WORK AREA CODE	4 X L -	514	

70.3 Table CC, Sequential Subtask Description. This table contains the sequential task narrative entered at the subtask level. The narrative will be entered in a step-by-step basis in order to document all subtasks required to perform the task under analysis. Subtasks should be detailed and sequenced to eliminate possibilities of technically incorrect procedures. Elements are subordinate to subtasks. All requirements for power, compressed air, and environmental considerations will be specified. Qualifying notes must be included when performance to particular standards, survivability requirements, inspection criteria, special procedures, tolerances, measurement ranges, cautions and safety precautions are required. Notes and warnings for set up of tasks (e.g., identifying support items which need to be on hand and ready, but are not needed until later in the task) should be documented in the first subtask. Similarly, notes and warnings for close-down of a task should be documented in the last subtask. In cases of multi-personnel tasks, the communication and coordination requirements between personnel must be documented (i.e., communication and coordination between individuals in one crew area with individuals in another area). Table keys consist of LCN (LSACONXB), LCN Type (LCNTYPXB), ALC (ALTLCNXB), EIAC (EIACODXA), Task Code (TASKCDCA), Subtask Number (SUBNUMCB), and Text Sequencing Code (TEXSEQCC).

a. The Element Indicator "E" is documented against the first line of a given element narrative and is blank for all subsequent lines of that element narrative.

b. Element narratives must begin on unique lines (Text Sequence Codes). For example, one element cannot end on line 12 and the next element begin on line 12 also.

MIL-STD-1388-2B
APPENDIX A

<u>CODE</u>	<u>DATA ELEMENT TITLE</u>	<u>FORMAT</u>	<u>DED</u>	<u>KEY</u>
EIACODXA	END ITEM ACRONYM CODE	10 X L -	096	F
LSACONXB	LSA CONTROL NUMBER (LCN)	18 X L -	199	F
ALTLCNXB	ALTERNATE LCN CODE	2 N F -	019	F
LCNTYPXB	LCN TYPE	1 A F -	203	F
TASKCDCA	TASK CODE	7 X F -	427	F
SUBNUMCB	SUBTASK NUMBER	3 N F -	407	F
TEXSEQCC	SEQUENTIAL SUBTASK DESCRIPTION TEXT SEQUENCING CODE	5 N R	450	K
SUBNARCC	SEQUENTIAL SUBTASK DESCRIPTION	65 X - -	372	
ELEMNTCC	ELEMENT INDICATOR	1 A F -	095	

70.4 Table CD, Subtask Personnel Requirement. This table contains information pertaining to personnel and support requirements for each entered subtask. Table keys consist of LCN (LSACONXB), LCN Type (LCNTYPXB), ALC (ALTLCNXB), EIAC (EIACODXA), Task Code (TASKCDCA), Subtask Number (SUBNUMCB), and Person Identifier (SUBPIDCD).

a. SSC (SKSPCDGA) and New or Modified SSC (MDCSSCGB) are migrated into this table as nonidentifying attributes which means that they are not required to uniquely identify an instance of the entity.

b. Unique Person IDs (SUBPIDED) can be assigned to each person required to perform a subtask and that Person ID-to-Person combination can be carried for the entire weapon system/EI. This method of coding Person IDs is recommended because it facilitates reporting manpower and personnel information and can be used to relate the Person ID to a specific Job. If this assignment logic is not used, the alternate Person ID assignment logic calls for entering a code which uniquely identifies each person required to perform a subtask or part of a subtask. If a person is used to perform more than one subtask, the same Person ID will be used throughout the entire task analysis. However, from one task to another, the same Person ID code can be repeated for different personnel.

<u>CODE</u>	<u>DATA ELEMENT TITLE</u>	<u>FORMAT</u>	<u>DED</u>	<u>KEY</u>
EIACODXA	END ITEM ACRONYM CODE	10 X L -	096	F
LSACONXB	LSA CONTROL NUMBER (LCN)	18 X L -	199	F
ALTLCNXB	ALTERNATE LCN CODE	2 N F -	019	F
LCNTYPXB	LCN TYPE	1 A F -	203	F
TASKCDCA	TASK CODE	7 X F -	427	F
SUBNUMCB	SUBTASK NUMBER	3 N F -	407	F
SUBPIDCD	SUBTASK PERSON IDENTIFIER	3 X L -	288	K
SKSPCDGA	SKILL SPECIALTY CODE	7 X L -	387	
MDCSSCGB	NEW OR MODIFIED SKILL SPECIALTY CODE	7 X L -	257	
SUBMMDCD	SUBTASK MEAN MAN-MINUTES	4 N R 1	226	
SSECDECD	SKILL SPECIALTY EVALUATION CODE	1 A F -	388	

70.5 Table CE, Task Remark. This table contains remarks relating to the task under analysis which are incorporated in the LSA-004 and LSA-033 reports. Table keys are EIAC (EIACODXA) and Task Remark Reference Code (TSKRRCCE).

MIL-STD-1388-2B
APPENDIX A

NOTE: Every Task Remark Reference Code and Task Remark combination is unique across all rows of information for a given EIAC. In other words, for the same EIAC, a given Task Remark Reference Code can only correspond to one Task Remark statement throughout the file structure.

<u>CODE</u>	<u>DATA ELEMENT TITLE</u>	<u>FORMAT</u>	<u>DED</u>	<u>KEY</u>
EIACODXA	END ITEM ACRONYM CODE	10 X L -	096	F
TSKRRCCE	TASK REMARK REFERENCE CODE	2 X F -	349	K
TSKREMCE	TASK REMARK	240 X -	432	

70.6 Table CF, Task Remark Reference. This table serves as a tie-in table between the TASK REQUIREMENT table (CA) and the TASK REMARK table (CE). Table keys consist of LCN (LSACONXB), LCN Type (LCNTYPXB), ALC (ALTLCNXB), EIAC (EIACODXA), and Task Code (TASKCDCA), which are migrated from table CA and the Task Remark Reference Code (TSKRRCCE), which migrates from table CE. EIACODXA from tables CA and CE must always be identical, therefore, duplication of that key in this table is not needed.

<u>CODE</u>	<u>DATA ELEMENT TITLE</u>	<u>FORMAT</u>	<u>DED</u>	<u>KEY</u>
EIACODXA	END ITEM ACRONYM CODE	10 X L -	096	F
LSACONXB	LSA CONTROL NUMBER (LCN)	18 X L -	199	F
ALTLCNXB	ALTERNATE LCN CODE	2 N F -	019	F
LCNTYPXB	LCN TYPE	1 A F -	203	F
TASKCDCA	TASK CODE	7 X F -	427	F
TSKRRCCE	TASK REMARK REFERENCE CODE	2 X F -	349	F

70.7 Table CG, Task Support Equipment. This table contains information which relates data needed for the task under analysis to the Support Equipment (SE) tables. This table serves as the tie-in between Task Analysis and SE areas for data which is to be incorporated into the LSA-070 series of reports (e.g., LSA-070, 072, 074, etc.). Table keys consist of LCN (LSACONXB), LCN Type (LCNTYPXB), ALC (ALTLCNXB), EIAC (EIACODXA), Task Code (TASKCDCA), Task Support Reference Number (TSFEFNCG), and Task Support CAGE Code (TSCAGECG).

a. In a given row, Quantity Per Task and Quantity Per Task Unit of Measure must either both be blank, or both have entries.

b. Based on the definitions for Item Category Codes (ICC) (DED 177), it is recommended that only items which fall under the following ICCs (identified in table EA by SEICCDEA) be entered in this table: 7, 8, M, D, 1, H, 4, 5, 6, 2, G, N, P, R, 3, S, T, E, F, J, U, V, AC, AD, and AF.

c. If the Training Equipment Requirement Code (TRNRQCCA) in table CA is "Y" for the subject LCN, ALC, and Task Code, at least one item of support equipment identified by the Task Support Reference Number (TSREFNCG) must have an ICC (SEICCDEA) of "S", "T", or "AF" entered against it in the EA table (match TSREFNCG and TSCAGECG with SEREFNEA and SECAGEEA, then check ICC).

<u>CODE</u>	<u>DATA ELEMENT TITLE</u>	<u>FORMAT</u>	<u>DED</u>	<u>KEY</u>
EIACODXA	END ITEM ACRONYM CODE	10 X L -	096	F

MIL-STD-1388-2B
APPENDIX A

LSACONXB	LSA CONTROL NUMBER (LCN)	18 X L -	199	F
ALTLCNXB	ALTERNATE LCN CODE	2 N F -	019	F
LCNTYPXB	LCN TYPE	1 A F -	203	F
TASKCDCA	TASK CODE	7 X F -	427	F
TSCAGECG	TASK SUPPORT CAGE CODE	5 X F -	046	F
TSREFNCG	TASK SUPPORT REFERENCE NUMBER	32 X L -	337	F
SQTYTKCG	SUPPORT ITEM QUANTITY PER TASK	5 N R 2	319	
SQTKUMCG	SUPPORT ITEM QUANTITY PER TASK UNIT OF MEASURE	2 A F -	491	

70.8 Table CH, Task Manual. This table ties in the narrative for the task under analysis to the corresponding Technical Manual (TM) which will contain the narrative. Table keys consist of LCN (LSACONXB), LCN Type (LCNTYPXB), ALC (ALTLCNXB), EIAC (EIACODXA), Task Code (TASKCDCA), and TM Code (TMCODEXI).

<u>CODE</u>	<u>DATA ELEMENT TITLE</u>	<u>FORMAT</u>	<u>DED</u>	<u>KEY</u>
EIACODXA	END ITEM ACRONYM CODE	10 X L -	096	F
LSACONXB	LSA CONTROL NUMBER (LCN)	18 X L -	199	F
ALTLCNXB	ALTERNATE LCN CODE	2 N F -	019	F
LCNTYPXB	LCN TYPE	1 A F -	203	F
TASKCDCA	TASK CODE	7 X F -	427	F
TMCODEXI	TECHNICAL MANUAL CODE	3 X F -	437	F

70.9 Table CI, Task Provisioned Item. This table will be used to obtain data from the Task Analysis area, which will be used in determining provisioning technical factors. In other words, this table links the provisioning area directly to the task area. This table should be used for documenting spares and repair parts needed in support of the subject task. Table keys consist of Task LCN (TSKLCNCI), Task LCN Type (TSKLTICI), Task ALC (TSKALCCI), and Task Provision Task Code (TSKTCDCI), which are migrated from table CA and Task Provision LCN (PROLCNCI), Task Provision ALC (PROALCCI), Task Provision LCN Type (PROLTICI), Task Provision CAGE Code (PROCAGCI), and Task Provision Reference Number (PROREFCI), which migrate from table HG. The EIACs (EIACODXA), which are resident in tables CA and HG, must be identical.

a. In a given row, Quantity Per Task and Quantity Per Task Unit of Measure must either both be blank, or both have entries.

b. For task code functions (1st position of Task Code) of H, there must be one Task Provision LCN that matches the Task LCN for all items required to support subject task (i.e., remove/replace of that LCN).

c. Based on definitions for ICCs (DED 177), it is recommended that only items which fall under the following ICCs be entered in this table (identified in table HG by ITMCATHG): Q, W, X, Y, Z, 9, K, L, AA, AB, AD, and AE.

<u>CODE</u>	<u>DATA ELEMENT TITLE</u>	<u>FORMAT</u>	<u>DED</u>	<u>KEY</u>
EIACODXA	END ITEM ACRONYM CODE	10 X L	096	F
TSKLCNCI	TASK LSA CONTROL NUMBER (LCN)	18 X L	199	F
TSKALCCI	TASK ALTERNATE LCN CODE (ALC)	2 N F	019	F

MIL-STD-1388-2B
APPENDIX A

TSKLTYCI	TASK LCN TYPE	1 A F	203	F
TSKTCDCI	TASK PROVISION TASK CODE	7 X F	427	F
PROCAGCI	TASK PROVISION CAGE CODE	5 X F	046	F
PROREFCI	TASK PROVISION REFERENCE NUMBER	32 X L	337	F
PROLCNCI	TASK PROVISION LCN	18 X L	199	F
PROALCCI	TASK PROVISION ALC	2 N F	019	F
PROLTYCI	TASK PROVISION LCN TYPE	1 A F	203	F
PQTYTKCI	PROVISION QUANTITY PER TASK	5 N R 2	319	
PQTKUMCI	PROVISION QUANTITY PER TASK UNIT OF MEASURE	2 A F	491	

70.10 Table CJ, Job and Duty Assignments. This table should be used to document jobs and duties personnel perform in a system. Documentation in this table is required if the Task Inventory report (LSA-018) is to be processed. Key data elements are Job Code (JOBDCDCJ) and Duty Code (DUTYDCDCJ).

<u>CODE</u>	<u>DATA ELEMENT TITLE</u>	<u>FORMAT</u>	<u>DED</u>	<u>KEY</u>
JOBDCDCJ	JOB CODE	2 X L -	186	K
DUTYDCDCJ	DUTY CODE	4 X L -	091	K
JOBDESCJ	JOB	40 X L -	185	
DUTIESCJ	DUTY	240 X L -	090	

70.11 Table CK, Task Inventory. This table is used as a cross reference to produce the Task Inventory report (LSA-018). Tables CC, CD, and CJ are combined in this cross reference table to identify the tasks, subtasks, and elements that are required for a given Job and Duty. Table keys include all columns. EIACODXA, LSAONXB, ALTLONXB, LCNTYXPB, TASKCDCA, and SUBNUMCB must be identical for tables CC and CD, migrating SUBPIDCD. Text Sequence Code From (TSFROMCK) and Text Sequence Code To (TEXTTOCK) migrate from TEXSEQCC, and therefore, each must match with a TEXSEQCC value for the given subtask.

a. JOBDCDCJ and DUTYDCDCJ must exist in table CJ prior to table CK.

b. For a given task, Job Code (JOBDCDCJ) must have a unique Person ID (SUBPIDCD).

<u>CODE</u>	<u>DATA ELEMENT TITLE</u>	<u>FORMAT</u>	<u>DED</u>	<u>KEY</u>
JOBDCDCJ	JOB CODE	2 X L -	186	F
DUTYDCDCJ	DUTY CODE	4 X L -	091	F
EIACODXA	END ITEM ACRONYM CODE	10 X L -	096	F
LSAONXB	LSA CONTROL NUMBER (LCN)	18 X L -	199	F
ALTLONXB	ALTERNATE LCN CODE	2 N F -	019	F
LCNTYXPB	LCN TYPE	1 A F -	203	F
TASKCDCA	TASK CODE	7 X F -	427	F
SUBNUMCB	SUBTASK NUMBER	3 N F -	407	F
TSFROMCK	SEQUENTIAL SUBTASK DESCRIPTION TEXT SEQUENCING CODE FROM	5 N R	450	F
TEXTTOCK	SEQUENTIAL SUBTASK DESCRIPTION TEXT SEQUENCING CODE TO	5 N R	450	F
SUBPIDCD	SUBTASK PERSON IDENTIFIER	3 X L -	288	F

MIL-STD-1388-2B
APPENDIX A

80. SUPPORT EQUIPMENT AND TRAINING MATERIEL REQUIREMENTS. Data tables identified by an "E" in the first position of the table code are structured to consolidate the pertinent information related to existing or new support/test equipment or training equipment. These tables contain most of the data that was captured on the old "E and E1" records. Much of this information serves as administrative type data for the Support Equipment Recommendation Data (SERD) report. This information also serves as identification of hardware and software elements required to conduct off-line tests. Figure 8 provides an entity diagram of these tables.

<u>TABLE CODE</u>	<u>TABLE TITLE</u>
EA	Support Equipment
EB	Allocation Data
EC	Support Equipment Parameters
ED	Support Equipment Authorization
EE	Support Equipment Narrative
EF	Support Equipment Recommendation Data
EG	Support Equipment Recommendation Data Revision Remarks
EH	Alternate National Stock Numbers
EI	Input Power Source
EJ	Support Equipment Design Data
EK	Supercedure Data
EL	Support Equipment Integrated Logistic Support Requirement Category Code
EM	System Equipment

80.1 Table EA, Support Equipment. This table captures a large portion of data which occurs one time per support/training equipment item. This table is used as the foundation for support/training equipment documentation as a whole. Table keys are Support Equipment (SE) Reference Number (SEREFNEA) and SE CAGE Code (SECAGEEA).

a. If Adapter/Interconnection Device Required (AIDRQDEA) is "Y", tables UI and UJ must be completed.

b. If entries exist for Operating Dimensions or Weight, Storage Dimensions or Weight, or Support Equipment Shipping Dimensions or Weight, their respective units of measure must have entries also.

c. Up to eight Using Service Designator Codes (USESEREA) can be entered at one time in a continuous string. This capability allows for all possible

MIL-STD-1388-2B
APPENDIX A



MIL-STD-1388-2B
APPENDIX A

combinations of using services to be entered.

<u>CODE</u>	<u>DATA ELEMENT TITLE</u>	<u>FORMAT</u>	<u>DED</u>	<u>KEY</u>
SECAGEEA	SUPPORT EQUIPMENT CAGE CODE	5 X F	046	F
SEREFNEA	SUPPORT EQUIPMENT REFERENCE NUMBER	32 X L	337	F
FLITNMEA	SUPPORT EQUIPMENT FULL ITEM NAME	42 X L	412	
SEICCDEA	SUPPORT EQUIPMENT ITEM CATEGORY CODE	2 X L	177	
AQDCOFEA	ACQUISITION DECISION OFFICE	15 X L	002	
ENDARTEA	END ARTICLE ITEM DESIGNATOR	26 X - -	179	
AIDRQDEA	ADAPTOR/INTERCONNECTION DEVICE REQUIRED	1 A F	005	
DATFADEA	DATE OF FIRST ARTICLE DELIVERY	6 N F	071	
CALINTEA	CALIBRATION INTERVAL	2 N R	037	
CALITMEA	CALIBRATION ITEM	1 A F	038	
CALRQDEA	CALIBRATION REQUIRED	1 A F	040	
CALSTDEA	CALIBRATION STANDARD	1 A F	041	
CALTIMEA	CALIBRATION TIME	5 N R 1	042	
CMRSRCEA	CALIBRATION MEASUREMENT REQUIREMENT SUMMARY RECOMMEND	1 A F	035	
CNTRNOEA	SUPPORT EQUIPMENT CONTRACT NUMBER	19 X L	055	
CFEGFEEA	CONTRACTOR FURNISHED EQUIPMENT/ GOVERNMENT FURNISH EQUIPMENT	1 A F	056	
CUSTCDEA	CUSTODY CODE	1 A F	069	
DRWCLSEA	DRAWING CLASSIFICATION	3 X - -	088	
ECOANLEA	ECONOMIC ANALYSIS	1 A F	093	
FAMGRPEA	FAMILY GROUP	10 X L	142	
GENECDEA	GENERIC CODE	5 X L	148	
GOVDESEA	GOVERNMENT DESIGNATOR	20 X L	149	
HDWRPREA	HARDWARE DEVELOPMENT PRICE	8 N R -	153	
ILSPRCEA	INTEGRATED LOGISTIC SUPPORT PRICE	8 N R -	170	
DSNPRCEA	DESIGN DATA PRICE	8 N R -	080	
EXUNPREA	EXTENDED UNIT PRICE	8 N R -	103	
PASTHREA	PASS THRU PRICE	8 N R -	285	
OSCOSTEA	OPERATING AND SUPPORT COST	8 N R -	267	
RCURCSEA	RECURRING COST	8 N R -	332	
LICYSTEA	LIFE CYCLE STATUS	1 A F	190	
LIFSPNEA	LIFE SPAN	2 N R	191	
LGCTCDEA	LOGISTIC CONTROL CODE	1 A F	197	
LGDCOFEA	LOGISTICS DECISION OFFICE	15 X L	198	
LSARCDEA	LSA RECOMMENDATION CODE	1 A F	204	
MGTPLNEA	MANAGEMENT PLAN	1 A F	216	
MGCOATEA	MANAGING COMMAND/AGENCY	10 X L	217	
SEMTBFEA	SUPPORT EQUIPMENT MEAN TIME BETWEEN FAILURES	10 D - -	229	
SMTBMAEA	SUPPORT EQUIPMENT MEAN TIME BETWEEN MAINTENANCE ACTIONS	10 D - -	230	
SEMTTREA	SUPPORT EQUIPMENT MEAN TIME TO REPAIR	5 N R 2	236	

MIL-STD-1388-2B
APPENDIX A

MOBFACEA	MOBILE FACILITY CODE	1 A F	248
MODCHGEA	MODIFICATION OR CHANGE	1 A F	252
OPRHGTEA	OPERATING HEIGHT	4 N R 1	268
OPLNGEA	OPERATING LENGTH	4 N R 1	268
OPWIDTEA	OPERATING WIDTH	4 N R 1	268
OPRWGTEA	OPERATING WEIGHT	6 N R 1	270
LWHOUMEA	OPERATING DIMENSIONS UNIT OF MEASURE	2 A F -	491
WGTOUMEA	OPERATING WEIGHT UNIT OF MEASURE	2 A F -	491
PCBLVLEA	PRINTED CIRCUIT BOARD REPAIR OPERATIONS/MAINTENANCE LEVEL	1 A F	277
CALLVLEA	SUPPORT EQUIPMENT CALIBRATION OPERATIONS/MAINTENANCE LEVEL	1 A F	277
RPRLVLEA	SUPPORT EQUIPMENT (SE) REPAIR OPERATIONS/MAINTENANCE LEVEL	1 A F	277
SMRCSEEA	SE SOURCE, MAINTENANCE AND RECOVERABILITY CODE	6 X L -	389
TMRQCDEA	TECHNICAL MANUAL REQUIRED CODE	17 X L	441
OPRMANEA	OPERATORS MANUAL	16 X L	278
SSCOPREA	SKILL SPECIALTY CODE FOR SUPPORT EQUIPMENT OPERATOR	7 X L	387
PREATYEA	PREPARING ACTIVITY	25 X L	294
PROELEEA	PROGRAM ELEMENT	3 X L	301
PSICPOEA	PROGRAM SUPPORT INVENTORY CONTROL POINT	2 X F	303
SERICCEA	REPORTABLE ITEM CONTROL CODE	1 N F	356
REVASSEA	REVOLVING ASSETS	4 X F	361
SLFTSTEA	SELF TEST CODE	1 A F	370
SENTRAEA	SENSORS OR TRANSDUCERS	1 A F	371
SERDESEA	SE SERVICE DESIGNATOR	1 A F	376
USESEREA	USING SERVICE DESIGNATOR CODE	8 A L -	376
SKETCHEA	SKETCH	1 A F	383
SPRFACEA	SPARE FACTOR	4 X F	390
SPMGNTEA	SPECIAL MANAGMENT CODE	1 A F	393
SIASCNEA	STANDARD INTERSERVICE AGENCY SERIAL CONTROL NUMBER	7 X F	401
STOHGTEA	STORAGE HEIGHT	4 N R 1	405
STOLENEA	STORAGE LENGTH	4 N R 1	405
STOWDTEA	STORAGE WIDTH	4 N R 1	405
STOWGTEA	STORAGE WEIGHT	6 N R 1	406
LWHSUMEA	STORAGE DIMENSIONS UNIT OF MEASURE	2 A F -	491
WGTSUMEA	STORAGE WEIGHT UNIT OF MEASURE	2 A F -	491
SESHPHEA	SUPPORT EQUIPMENT SHIPPING HEIGHT	4 N R 1	419
SESHPLEA	SUPPORT EQUIPMENT SHIPPING LENGTH	4 N R 1	419
SESHPWEA	SUPPORT EQUIPMENT SHIPPING WIDTH	4 N R 1	419
SESHWTEA	SUPPORT EQUIPMENT SHIPPING WEIGHT	6 N R 1	420
UMSHIPEA	SUPPORT EQUIPMENT SHIPPING DIMENSIONS UNIT OF MEASURE	2 A F -	491

MIL-STD-1388-2B
APPENDIX A

UMSEWTEA	SUPPORT EQUIPMENT SHIPPING WEIGHT UNIT OF MEASURE	2 A F -	491
SEGRCDEA	SUPPORT EQUIPMENT GROUPING	3 N F	413
SEREQDEA	SUPPORT EQUIPMENT REQUIRED	1 A F	418
TECEVLEA	TECHNICAL EVALUATION PRIORITY CODE	3 X F	435
TSTLNGEA	TEST LANGUAGE	6 A L	443
TSTPTSEA	TEST POINTS	1 A F	446
TMDERCEA	TEST MEASUREMENT AND DIAGNOSTIC EQUIPMENT REGISTER CODE	1 A F	444
TMDERIEA	TEST MEASUREMENT AND DIAGNOSTIC EQUIPMENT REGISTER INDEX NUMBER	7 X F	445
TYPCLSEA	TYPE CLASSIFICATION	1 A F	479
TYPEEQEA	TYPE EQUIPMENT CODE	4 X L	480
YRFLDGEA	YEAR OF FIELDING	2 N F	518

80.2 Table EB, Allocation Data. This table allows documenting of specific information relating allocation documents to discrete facility types and maintenance levels. Ten allowance ranges can be documented to describe the quantity of SE or Automatic Test Equipment (ATE) items necessary to support the number of end articles related to each discrete range of supported end item density. DED 015 dictates the value of each range for the number of pieces of: (a) end items; (b) ATE items; or, (c) depot overhaul requirements that the entered quantity of SE can support. Table keys are SE Reference Number (SEREFNEA), SE CAGE Code (SECAGEEA), and Allowance Document Number (ALDCNMEB).

<u>CODE</u>	<u>DATA ELEMENT TITLE</u>	<u>FORMAT</u>	<u>DED</u>	<u>KEY</u>
SECAGEEA	SUPPORT EQUIPMENT (SE) CAGE CODE	5 X F	046	F
SEREFNEA	SE REFERENCE NUMBER	32 X L	337	F
ALDCNMEB	ALLOWANCE DOCUMENT NUMBER	10 X L	016	K
ALORG1EB	ALLOWABLE RANGE 1	3 N R -	015	
ALORG2EB	ALLOWABLE RANGE 2	3 N R -	015	
ALORG3EB	ALLOWABLE RANGE 3	3 N R -	015	
ALORG4EB	ALLOWABLE RANGE 4	3 N R -	015	
ALORG5EB	ALLOWABLE RANGE 5	3 N R -	015	
ALORG6EB	ALLOWABLE RANGE 6	3 N R -	015	
ALORG7EB	ALLOWABLE RANGE 7	3 N R -	015	
ALORG8EB	ALLOWABLE RANGE 8	3 N R -	015	
ALORG9EB	ALLOWABLE RANGE 9	3 N R -	015	
ALRG10EB	ALLOWABLE RANGE 10	3 N R -	015	
ALDNDSEB	ALLOCATION DESIGNATION DESCRIPTION	9 X L	015	
ALEXRNEB	ALLOCATION EXTENDED RANGE	3 X R	015	
ALLVCDEB	ALLOCATION LAND VESSEL CODE	1 A F	015	
ALMLVLEB	ALLOCATION MAINTENANCE LEVEL FUNCTION	2 X L	015	
ALSTIDEB	ALLOCATION STATION IDENTIFICATION CODE	5 X L	015	

80.3 Table EC, Support Equipment Parameters. This table allows documenting

MIL-STD-1388-2B
APPENDIX A

the discrete parameters which can be measured, generated, etc., by the support/training equipment. The capabilities documented here are the basis for determining suitability of an SE item when compared to the unit under test (UUT) parameters. This table can be used to document parameters for either CMRS Category II or Category III SE. Table keys are SE Reference Number (SEREFNEA), SE CAGE Code (SECAGEEA), and Parameter Group Code (PARGPCEC).

<u>CODE</u>	<u>DATA ELEMENT TITLE</u>	<u>FORMAT</u>	<u>DED</u>	<u>KEY</u>
SECAGEEA	SUPPORT EQUIPMENT CAGE CODE	5 X F -	046	F
SEREFNEA	SUPPORT EQUIPMENT REFERENCE NUMBER	32 X L -	337	F
PARGPCEC	SUPPORT EQUIPMENT PARAMETER GROUP CODE	2 A F -	284	K
CALPROEC	CALIBRATION PROCEDURE	20 X L -	039	
PARPAREC	SUPPORT EQUIPMENT PARAMETER	12 X L -	284	
RNGFRMEC	SUPPORT EQUIPMENT PARAMETER RANGE FROM	10 D - -	284	
RNGTOCEC	SUPPORT EQUIPMENT PARAMETER RANGE TO	10 D - -	284	
PARACCEC	SUPPORT EQUIPMENT PARAMETER ACCURACY	26 X L -	284	
SPARIOEC	SUPPORT EQUIPMENT PARAMETER INPUT OUTPUT CODE	1 A L -	284	
PARRVCEC	SUPPORT EQUIPMENT PARAMETER RANGE/VALUE CODE	1 A F -	284	

80.4 Table ED, Support Equipment Authorization. This table allows documenting specific activities and quantities to which the SE item is to be authorized, as well as the location of each activity. Table keys are SE Reference Number (SEREFNEA), SE CAGE Code (SECAGEEA), and Activity Name/Location (ACTNAMED).

<u>CODE</u>	<u>DATA ELEMENT TITLE</u>	<u>FORMAT</u>	<u>DED</u>	<u>KEY</u>
SECAGEEA	SUPPORT EQUIPMENT (SE) CAGE CODE	5 X F -	046	F
SEREFNEA	SE REFERENCE NUMBER	32 X L -	337	F
ACTNAMED	ACTIVITY NAME/LOCATION	50 X L -	399	K
TYPACTED	TYPE OF ACTIVITY	15 X L -	399	
NUMACTED	NUMBER OF ACTIVITIES	3 N R -	399	
SEQTYAED	SUPPORT EQUIPMENT QUANTITY PER ACTIVITY	3 N R -	399	

80.5 Table EE, Support Equipment Narrative. This table is used to document different types of narrative text for SE. Each type of narrative is dependent upon the SE CAGE Code (SECAGEEA) and SE Reference Number (SEREFNEA) as migrating keys from table EA. Additional keys include SE Narrative Text Sequencing Code (TEXSEQEE) and SE Narrative Code (SENARCEE). The SE Narrative Codes (DED 414) correspond to the different types of narratives. The following list gives each of these codes, related narrative title, and (DED) number to refer to for an understanding of the information that needs to be input:

MIL-STD-1388-2B
APPENDIX A

<u>CODE</u>	<u>NARRATIVE TITLE</u>	<u>DED NUMBER</u>
A	Functional Analysis	147
B	Description and Function of SE	078
C	SE Nonproliferation Effort	415
D	Characteristics of SE	044
E	Installation Factors or Other Facilities	169
F	Additional Skills and Special Training Requirements	008
G	SE Explanation	411
H	Justification	188

<u>CODE</u>	<u>DATA ELEMENT TITLE</u>	<u>FORMAT</u>	<u>DED</u>	<u>KEY</u>
SECAGEEA	SUPPORT EQUIPMENT CAGE CODE	5 X F -	046	F
SEREFNEA	SUPPORT EQUIPMENT REFERENCE NUMBER	32 X L -	337	F
TEXSEQEE	SUPPORT EQUIPMENT NARRATIVE TEXT SEQUENCING CODE	5 N R -	450	K
SENARCEE	SUPPORT EQUIPMENT NARRATIVE CODE	1 A F -	414	K
SEQNAREE	SUPPORT EQUIPMENT NARRATIVE	65 X - -	---	

80.6 Table EF, Support Equipment Recommendation Data. This table allows documenting SERD specific information such as, submittal and disposition dates. Table keys are SE Reference Number (SEREFNEA), SE CAGE Code (SECAGEEA), SERD Number (SERDNOEF), and SERD Revision (SRDREVEF).

<u>CODE</u>	<u>DATA ELEMENT TITLE</u>	<u>FORMAT</u>	<u>DED</u>	<u>KEY</u>
SECAGEEA	SUPPORT EQUIPMENT (SE) CAGE CODE	5 X F -	046	F
SEREFNEA	SE REFERENCE NUMBER	32 X L -	337	F
SERDNOEF	SUPPORT EQUIPMENT RECOMMENDATION DATA (SERD) NUMBER	10 X F -	416	K
SRDREVEF	SERD REVISION	2 A R -	360	K
STATUSEF	SERD STATUS	1 A F -	404	
INTSUBEF	SERD DATE OF INITIAL SUBMISSION	6 N F -	071	
DTGVDSEF	SERD DATE OF GOVERNMENT DISPOSITION	6 N F -	071	
DTRVSBEF	SERD DATE OF REVISION SUBMISSION	6 N F -	071	

80.7 Table EG, Support Equipment Recommendation Data Revision Remarks. This table allows documenting, for a SERD revision, the revision letter, revision date, action date, and revision remarks, which summarize the reason for revision, within a narrative field. For SERDs that have been revised more than once, this block shall include the revision data and remarks of all previous revisions, and therefore, serve as a history for the SERD. Table keys are SE Reference Number (SEREFNEA), SE CAGE Code (SECAGEEA), SERD Number (SERDNOEF), and Text Sequencing Code (TEXSEQEG).

MIL-STD-1388-2B
APPENDIX A

<u>CODE</u>	<u>DATA ELEMENT TITLE</u>	<u>FORMAT</u>	<u>DED</u>	<u>KEY</u>
SECAGEEA	SUPPORT EQUIPMENT CAGE CODE	5 X F -	046	F
SEREFNEA	SUPPORT EQUIPMENT REFERENCE NUMBER	32 X L -	337	F
SERDNOEF	SUPPORT EQUIPMENT RECOMMENDATION DATA (SERD) NUMBER	10 X F	416	F
SRDREVEF	SERD REVISION	2 A R -	360	F
TEXSEQEG	SERD REVISION TEXT SEQUENCING CODE	5 N R -	450	K
REVREMEG	SERD REVISION REMARKS	65 X L -	417	

80.8 Table EH, Alternate National Stock Number. This table allows documenting alternate NSNs of items which may be substituted for the subject Support/Training Equipment item. This information is used specifically by the SERD report (LSA-070). Table keys are SE Reference Number (SEREFNEA), SE CAGE Code (SECAGEEA), SERD Number (SERDNOEF), Alternate NSN Federal Supply Classification (ALTFSCHE), and Alternate NSN National Item Identification Code (ALTNIIEH).

<u>CODE</u>	<u>DATA ELEMENT TITLE</u>	<u>FORMAT</u>	<u>DED</u>	<u>KEY</u>
SECAGEEA	SUPPORT EQUIPMENT CAGE CODE	5 X F -	046	F
SEREFNEA	SUPPORT EQUIPMENT REFERENCE NUMBER	32 X L -	337	F
SERDNOEF	SUPPORT EQUIPMENT RECOMMENDATION DATA NUMBER	10 X F -	416	F
SRDREVEF	SERD REVISION	2 A R -	360	F
ALTFSCHE	ALTERNATE NATIONAL STOCK NUMBER (NSN) FEDERAL SUPPLY CLASSIFICATION	4 N F -	253	K
ALTNIIEH	ALTERNATE NSN NATIONAL ITEM IDENTIFICATION NUMBER	9 X F -	253	K

80.9 Table EI, Input Power Source. This table is utilized to document power requirements to operate the support/training equipment under analysis. Included are voltage levels, frequency ranges, power requirements, phase type, and alternating or direct current data. Table keys are SE Reference Number (SEREFNEA), SE CAGE Code (SECAGEEA), and Source Option Number (IPSOPNEI).

a. The Source Option Number should be assigned sequentially from 1 to 99 (manually or automatically) for each unique set of power requirements for a subject piece of SE.

b. A unique set of power requirements could have only one value different from another set of power requirements.

<u>CODE</u>	<u>DATA ELEMENT TITLE</u>	<u>FORMAT</u>	<u>DED</u>	<u>KEY</u>
SECAGEEA	SUPPORT EQUIPMENT CAGE CODE	5 X F	046	F
SEREFNEA	SUPPORT EQUIPMENT REFERENCE NUMBER	32 X L	337	F
IPSOPNEI	SOURCE OPTION NUMBER	2 N R	168	K

MIL-STD-1388-2B
APPENDIX A

IPACDCEI	INPUT POWER SOURCE ALTERNATING CURRENT/DIRECT CURRENT	1 A F	168
IPFRMXEI	INPUT POWER SOURCE FREQUENCY RANGE MAXIMUM	3 N R	168
IPRGMXEI	INPUT POWER SOURCE FREQUENCY RANGE MINIMUM	3 N R	168
IPSRGMEI	INPUT POWER SOURCE OPERATING RANGE MAXIMUM	3 N R	168
IPOPRGEI	INPUT POWER SOURCE OPERATING RANGE MINIMUM	3 N R	168
IPMXRPEI	INPUT POWER SOURCE PERCENT MAXIMUM RIPPLE	4 N R 2	168
IPPHASEI	INPUT POWER SOURCE PHASE	1 N F	168
IPPOWREI	INPUT POWER SOURCE WATTS	5 N R	168

80.10 Table EJ, Support Equipment Design Data. This table allows documenting detailed cost, requirement, and recommendation information for the various design data elements (see DED 079). Table keys are SE Reference Number (SEREFNEA), SE CAGE Code (SECAGEEA), as well as Design Data Category Code (codes for each design data element) (DSNDATEJ).

<u>CODE</u>	<u>DATA ELEMENT TITLE</u>	<u>FORMAT</u>	<u>DED</u>	<u>KEY</u>
SECAGEEA	SUPPORT EQUIPMENT CAGE CODE	5 X F	046	F
SEREFNEA	SUPPORT EQUIPMENT REFERENCE NUMBER	32 X L	337	F
DSNDATEJ	DESIGN DATA CATEGORY CODE (DDCC)	1 A F	079	K
CNTRECEJ	DDCC CONTRACTOR RECOMMENDED	1 A F	057	
ESTPRCEJ	DDCC ESTIMATED PRICE	8 N R	101	
GOVRQDEJ	DDCC GOVERNMENT REQUIRED	1 A F	150	
DDCCSCEJ	DDCC SCOPE	40 X L	365	

80.11 Table EK, Supercedure Data. This table provides information about the item replacing, or being replaced, by the SE item under analysis. This information is normally regulated by SERD number, but may be governed by reference number and CAGE. Table keys are SE Reference Number (SEREFNEA), SE CAGE Code (SECAGEEA), as well as Supercedure CAGE Code (SPRCAGEK) and Supercedure Reference Number (SPRREFEK), which migrate from table HA and are given the role name "Supercedure".

NOTE: It is mandatory that the Supercedure Type element (SUTYPEEK) be completed.

<u>CODE</u>	<u>DATA ELEMENT TITLE</u>	<u>FORMAT</u>	<u>DED</u>	<u>KEY</u>
SECAGEEA	SUPPORT EQUIPMENT CAGE CODE	5 X F	046	F
SEREFNEA	SUPPORT EQUIPMENT REFERENCE NUMBER	32 X L	337	F
SPRCAGEK	SUPERCEDURE CAGE CODE	5 X F	046	F
SPRREFEK	SUPERCEDURE REFERENCE NUMBER	32 X L	337	F
SUTYPEEK	SUPERCEDURE TYPE	1 X F	408	M
SUPITNEK	SUPERCEDURE ITEM NAME	19 X L -	182	

MIL-STD-1388-2B
APPENDIX A

SUSRNOEK	SUPERCEDURE SUPPORT EQUIPMENT RECOMMENDATION DATA NUMBER	10 X F	416
REASUPEK	REASON FOR SUPERCEDURE/DELETION	2 X F -	327
ICCODEEK	SUPERCEDURE INTERCHANGEABILITY CODE	2 X L -	172

80.12 Table EL, Support Equipment Integrated Logistic Support Requirement Category Code. This table allows documenting the element(s) of ILS which are required or recommended to be addressed for the SE item. Also included are the estimated price, whether government required or contractor recommended, and a scope (normally a data item description) for each ILS element documented. Table keys are SE Reference Number (SEREFNEA), SE CAGE Code (SECAGEEA), as well as SE ILS Requirement Category Code (IRCCODEL).

<u>CODE</u>	<u>DATA ELEMENT TITLE</u>	<u>FORMAT</u>	<u>DED</u>	<u>KEY</u>
SECAGEEA	SUPPORT EQUIPMENT CAGE CODE	5 X F	046	F
SEREFNEA	SUPPORT EQUIPMENT REFERENCE NUMBER	32 X L	337	F
IRCCODEL	INTEGRATED LOGISTIC SUPPORT REQUIREMENT CATEGORY CODE (IRCC)	1 A F	171	K
CONRECEL	IRCC CONTRACTOR RECOMMENDED	1 A F	057	
ESTPRCEL	IRCC ESTIMATED PRICE	8 N R	101	
GOVRQDEL	IRCC GOVERNMENT REQUIRED	1 A F	150	
IRCSOCEL	IRCC SCOPE	40 X L	365	

80.13 Table EM, System Equipment. This table allows documenting items which are components of the system/equipment and are necessary to be used in conjunction with the SE item to perform its intended function. For example, a wiring harness with the same part number as the one used on the system/equipment might be required at test bench in order to fault isolate a line replaceable unit (LRU). This wiring harness would be considered a required piece of system equipment. Table Keys include System CAGE (SCAGECEM) and System Reference Number (SREFNOEM) (both migrate from table HA, but are given "System" role name), and SE CAGE Code (SECAGEEA) and SE Reference Number (SEREFNEA) (migrate from table EA).

<u>CODE</u>	<u>DATA ELEMENT TITLE</u>	<u>FORMAT</u>	<u>DED</u>	<u>KEY</u>
SECAGEEA	SUPPORT EQUIPMENT (SE) CAGE CODE	5 X F -	046	F
SEREFNEA	SE REFERENCE NUMBER	32 X L -	337	F
SCAGECEM	SYSTEM CAGE CODE	5 X F -	046	F
SREFNOEM	SYSTEM REFERENCE NUMBER	32 X L -	337	F
QTYTSTEM	SYSTEM EQUIPMENT QUANTITY PER TEST	3 N R -	320	
GFAEIDEM	SYSTEM EQUIPMENT ITEM DESIGNATOR	26 X L -	179	

MIL-STD-1388-2B
APPENDIX A

90. UNIT UNDER TEST REQUIREMENTS AND DESCRIPTION. Data tables beginning with "U" in the first position of the table code are structured to identify the UUT and those hardware and software elements required to test the UUT with off-line support/test equipment. The unique combination of these elements required for a specific UUT and support/test equipment configuration is a Test Program Set (TPS). In addition to defining the TPS elements, this information provides the configuration identification of the UUT (i.e., the UUT and the support/test equipment to be used in the test). This information is established for each UUT which has a requirement to be tested by the support/test equipment documented. Additionally, Calibration and Measurement Requirement Summary (CMRS) information is captured in these tables. Figure 9 depicts the relational hierarchy of these tables/entities.

<u>TABLE CODE</u>	<u>TABLE TITLE</u>
UA	Article Requiring Support/Unit Under Test
UB	Unit Under Test Support Equipment
UC	Operational Test Program
UD	Unit Under Test Support Equipment Operational Test Program
UE	Test Program Instruction
UF	Unit Under Test Explanation
UG	Unit Under Test Parameter Group
UH	Unit Under Test Fault Isolated Replaceable Unit
UI	Adapter-Interconnector Device
UJ	Unit Under Test Support Equipment Adapter-Interconnector Device
UK	Automatic Test Equipment Test Station
UL	Unit Under Test Support Equipment Automatic Test Equipment
UM	Support Equipment Item Unit Under Test
UN	Support Equipment Unit Under Test Parameter Group

90.1 Table UA, Article Requiring Support/Unit Under Test. This table identifies the UUT which is a component of weapon system breakdown structure. A UUT can be either a component of the system/equipment or a piece of complex SE itself which must be documented under the end article (weapon system) for contractual or provisioning purposes. Table keys are migrated from table XB, but are given the role name "UUT" to distinguish them (UUTLCNUA, UUTALCUA, and UTLCNTUA). The EIAC must be the same as in table XB, therefore it, is not role named.

MIL-STD-1388-2B
APPENDIX A

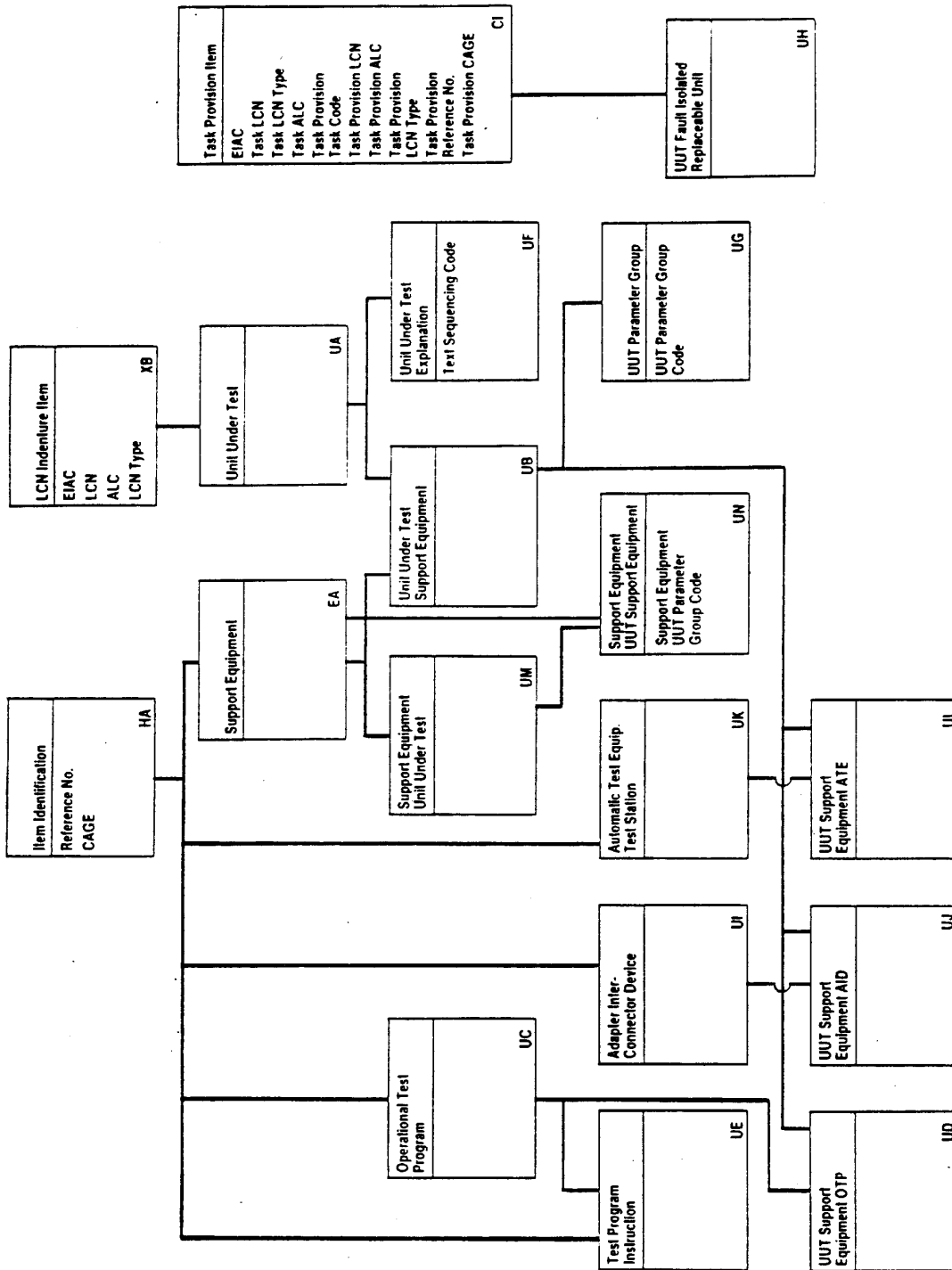

MIL-STD-1388-2B
APPENDIX A

NOTE: The keys (EIACODXA, UUTLCNUA, UUTALCUA, and UTLCNTUA) must have a matching set of identical values already established in table CA (Task Requirement).

<u>CODE</u>	<u>DATA ELEMENT TITLE</u>	<u>FORMAT</u>	<u>DED</u>	<u>KEY</u>
EIACODXA	END ITEM ACRONYM CODE	10 X L -	096	F
UUTLCNUA	UUT LSA CONTROL NUMBER (LCN)	18 X L -	199	F
UUTALCUA	UUT ALTERNATE LCN CODE	2 N F -	019	F
UTLCNTUA	UUT LCN TYPE	1 A F -	203	F
UTALLOUA	UUT ALLOWANCE	10 X L -	016	
UMNTPLUA	UUT MAINTENANCE PLAN NUMBER	23 X L -	209	
UTTRDNUA	UUT TEST REQUIREMENTS DOCUMENT NUMBER	15 X L -	448	
UTWPRFUA	UUT WORK PACKAGE REFERENCE	6 X L -	515	

90.2 Table UB, Unit Under Test Support Equipment. This table serves as the tie-in between the SE and the UUT. Keys are migrated into table UB from the EA and UA tables. Table keys are EIAC (EIACODXA), UUT LCN (UUTLCNUA), UUT ALC (UUTALCUA), UUT LCN Type (UTLCNTUA), SE Reference Number (SEREFNEA), and SE CAGE Code (SECAGEEA).

<u>CODE</u>	<u>DATA ELEMENT TITLE</u>	<u>FORMAT</u>	<u>DED</u>	<u>KEY</u>
EIACODXA	END ITEM ACRONYM CODE	10 X L -	096	F
UUTLCNUA	UUT LSA CONTROL NUMBER (LCN)	18 X L -	199	F
UUTALCUA	UUT ALTERNATE LCN CODE	2 N F -	019	F
UTLCNTUA	UUT LCN TYPE	1 A F -	203	F
SECAGEEA	SUPPORT EQUIPMENT CAGE CODE	5 X F	046	F
SEREFNEA	SUPPORT EQUIPMENT REFERENCE NUMBER	32 X L	337	F
UTSTCDUB	UUT CALIBRATION/MEASUREMENT REQUIREMENT SUMMARY STATUS	1 A F -	036	
UTCMRSUB	UUT CALIBRATION MEASUREMENT REQUIREMENTS SUMMARY RECOMMENDED CODE	1 X F -	035	

90.3 Table UC, Operational Test Program. This table allows documenting identification and cost data pertaining to the Operational Test Program (OTP). The OTP is used in conjunction with another support equipment item, normally ATE. This table provides supporting information to the UD table. Keys are migrated from the HA table and given the role name "OTP" to distinguish them (OTPCAGUC and OTPREFUC).

<u>CODE</u>	<u>DATA ELEMENT TITLE</u>	<u>FORMAT</u>	<u>DED</u>	<u>KEY</u>
OTPCAGUC	OPERATIONAL TEST PROGRAM (OTP) CAGE CODE	5 X F	046	F
OTPREFUC	OTP REFERENCE NUMBER	32 X L	337	F
OTPACRUC	OTP APPORTIONED UNIT COST RECURRING	8 N R	025	
OTPACNUC	OTP APPORTIONED UNIT COST NONRECURRING	8 N R	025	

MIL-STD-1388-2B
APPENDIX A

OTPCTPUC	OTP COORDINATED TEST PLAN	1 X F	060
OTPSFCUC	OTP STANDARDS FOR COMPARISON	1 X F	402
OTPSRDUC	OTP SUPPORT EQUIPMENT RECOMMENDATION DATA NUMBER	10 X F	416

90.4 Table UD, Unit Under Test Support Equipment Operational Test Program. This table ties together the relationship between the SE, UUT, and the OTP to maintain the specific application of the OTP. Table keys are EIAC (EIACODXA), UUT LCN (UUTLCNUA), UUT ALC (UUTALCUA), UUT LCN Type (UTLCNTUA), SE Reference Number (SEREFNEA), SE CAGE Code (SECAGEEA) (these migrate from the UB table), and OTP Reference Number (OTPREFUC) and OTP CAGE Code (OTPCAGUC), which migrate from the UC table.

<u>CODE</u>	<u>DATA ELEMENT TITLE</u>	<u>FORMAT</u>	<u>DED</u>	<u>KEY</u>
EIACODXA	END ITEM ACRONYM CODE	10 X L -	096	F
UUTLCNUA	UUT LSA CONTROL NUMBER (LCN)	18 X L -	199	F
UUTALCUA	UUT ALTERNATE LCN CODE	2 N F -	019	F
UTLCNTUA	UUT LCN TYPE	1 A F -	203	F
SECAGEEA	SUPPORT EQUIPMENT CAGE CODE	5 X F	046	F
SEREFNEA	SUPPORT EQUIPMENT REFERENCE NUMBER	32 X L	337	F
OTPCAGUC	OPERATIONAL TEST PROGRAM CAGE CODE	5 X F	046	F
OTPREFUC	OPERATIONAL TEST PROGRAM REFERENCE NUMBER	32 X L	337	F

90.5 Table UE, Test Program Instruction. This table allows documenting basic identification and cost information pertaining to a test program instruction (TPI). The TPI is used as an aid in the use of an OTP. Table keys are migrated from the HA table and given the role name "TPI" to form the following keys: TPI Reference Number (TPIREFUE) and TPI CAGE Code (TPICAGUE). Also, the keys from table UC (OTP CAGE and Reference Number) are migrated in as foreign keys.

<u>CODE</u>	<u>DATA ELEMENT TITLE</u>	<u>FORMAT</u>	<u>DED</u>	<u>KEY</u>
OTPCAGUC	OPERATIONAL TEST PROGRAM CAGE CODE	5 X F	046	F
OTPREFUC	OPERATIONAL TEST PROGRAM REFERENCE NUMBER	32 X L	337	F
TPICAGUE	TEST PROGRAM INSTRUCTION (TPI) CAGE CODE	5 X F	046	F
TPIREFUE	TPI REFERENCE NUMBER	32 X L	337	F
TPAUCRUE	TPI APPORTIONED UNIT COST RECURRING	8 N R	025	
TPAUCNUE	TPI APPORTIONED UNIT COST NONRECURRING	8 N R	025	
TPISTSUE	TPI SELF TEST	1 A F	370	
TPITDPUE	TPI TECHNICAL DATA PACKAGE	1 A F	434	

MIL-STD-1388-2B
APPENDIX A

TPISRDUE TPI SUPPORT EQUIPMENT 10 X F 416
 RECOMMENDATION DATA NUMBER

90.6 Table UF, Unit Under Test Explanation. Narrative statements may be entered in this table to further explain, justify, or substantiate any data entry concerning UUT (U tables) related data elements. When the information is related to a specific data element, the explanation should be prefaced with a reference to that element. Table keys are migrated from table UA and include EIAC (EIACODXA), UUT LCN (UUTLCNUA), UUT ALC (UUTALCUA), and UUT LCN Type (UTLCNTUA). Also, Text Sequencing Code (TEXSEQUF) is a key attribute.

<u>CODE</u>	<u>DATA ELEMENT TITLE</u>	<u>FORMAT</u>	<u>DED</u>	<u>KEY</u>
EIACODXA	END ITEM ACRONYM CODE	10 X L -	096	F
UUTLCNUA	UUT LSA CONTROL NUMBER (LCN)	18 X L -	199	F
UUTALCUA	UUT ALTERNATE LCN CODE	2 N F -	019	F
UTLCNTUA	UUT LCN TYPE	1 A F -	203	F
TEXSEQUF	UUT EXPLANATION TEXT SEQUENCING CODE	5 N R -	450	K
UTEXPLUF	UUT EXPLANATION	65 X - -	498	

90.7 Table UG, Unit Under Test Parameter Group. This table allows documenting specific information about individual parameters which the unit under test requires to have measured, generated, etc. by the support equipment. This table is used when the UUT is a subelement of the system/equipment (CMRS category I item), as opposed to being another piece of support equipment, with one exception. This table can be used to document parameters for a piece of complex SE which is an LSA candidate, thereby, making it the UUT. Table keys are EIAC (EIACODXA), UUT LCN (UUTLCNUA), UUT ALC (UUTALCUA), UUT LCN Type (UTLCNTUA), SE Reference Number (SEREFNEA), and SE CAGE Code (SECAGEEA).

NOTE: The UUT Parameter Grouping Code (UUTPGCUG) and the SE Parameter Grouping Code (PARGPCEC) (table EC) provide the common link between the parameters that need to be tested by the UUT and the parameters that the piece of SE can test. Therefore, the values for UUTPGCUG and PARGPCEC must be identical to link the UUT to the corresponding piece of SE.

<u>CODE</u>	<u>DATA ELEMENT TITLE</u>	<u>FORMAT</u>	<u>DED</u>	<u>KEY</u>
EIACODXA	END ITEM ACRONYM CODE	10 X L -	096	F
UUTLCNUA	UUT LSA CONTROL NUMBER (LCN)	18 X L -	199	F
UUTALCUA	UUT ALTERNATE LCN CODE	2 N F -	019	F
UTLCNTUA	UUT LCN TYPE	1 A F -	203	F
SECAGEEA	SUPPORT EQUIPMENT CAGE CODE	5 X F	046	F
SEREFNEA	SUPPORT EQUIPMENT REFERENCE NUMBER	32 X L	337	F
UUTPGCUG	UUT PARAMETER GROUP CODE	2 A F -	284	K
UUTPPCUG	UUT CALIBRATION MEASUREMENT REQUIREMENT SUMMARY PARAMETER CODE	1 A F	034	
UUTPACUG	UUT PARAMETER ACCURACY	26 X L	284	
UUTPIOUG	UUT PARAMETER INPUT/OUTPUT CODE	1 A F	284	

MIL-STD-1388-2B
APPENDIX A

UUTPSOUG	UUT PARAMETER OPERATIONAL/ SPECIFICATION CODE	1 A F	284
UUTPARUG	UUT PARAMETER	12 X L	284
UUTPRFUG	UUT PARAMETER RANGE FROM	10 D - -	284
UUTPRTUG	UUT PARAMETER RANGE TO	10 D - -	284
UUTPRVUG	UUT PARAMETER RANGE/VALUE CODE	1 A F	284
UUTPTAUG	UUT PARAMETER TEST ACCURACY RATIO (TAR) ACTUAL	1 X F	442
UUTPTDUG	UUT PARAMETER TAR DESIRED	1 X F	442

90.8 Table UH, Unit Under Test Fault Isolated Replaceable Unit. This table allows documenting the relationship between SE, UUT, task provisioned items, and Fault Isolated Replaceable Units (FIRU). The FIRU is an item which is subordinate to the UUT LCN (UUTLCNUA) and the Task LCN (TSKLCNCI) in hardware breakdown. In fact, the UUT LCN and the Task LCN are one in the same and therefore, must be identical to each other. This table also allows documenting the percentage of faults which can be isolated to a given ambiguity group (up to two groups) and its respective number of items per ambiguity group. Table keys include those which originate in table CI (EIACODXA, TSKLCNCI, TSKALCCI, TSKLTYCI, TSKTCDCI, PROLCNCI, PROALCCI, PROLTYCI, PROCAGCI, and PROREFCI) and are migrated to table UH. Keys from table EA migrate down as nonidentifying.

- a. PROLCNCI must be subordinate to TSKLCNCI.
- b. PROLCNCI identifies the FIRU item.
- c. To qualify as an FIRU, the PROLCNCI must have an ICC of X, Y, 9, AA, or AB (identified in table HG) and must be identifiable through fault isolation procedures for the TSKLCNCI.

<u>CODE</u>	<u>DATA ELEMENT TITLE</u>	<u>FORMAT</u>	<u>DED</u>	<u>KEY</u>
EIACODXA	END ITEM ACRONYM CODE	10 X L	096	F
TSKLCNCI	TASK LSA CONTROL NUMBER (LCN)	18 X L -	199	F
TSKALCCI	TASK ALTERNATE LCN CODE (ALC)	2 N F	019	F
TSKLTYCI	TASK LCN TYPE	1 A F -	203	F
TSKTCDCI	TASK PROVISION TASK CODE	7 X F -	427	F
PROLCNCI	TASK PROVISION LCN	18 X L -	199	F
PROALCCI	TASK PROVISION ALC	2 N F -	019	F
PROLTYCI	TASK PROVISION LCN TYPE	1 A F -	203	F
PROCAGCI	TASK PROVISION CAGE CODE	5 X F -	046	F
PROREFCI	TASK PROVISION REFERENCE NUMBER	32 X L -	337	F
SECAGEEA	SUPPORT EQUIPMENT CAGE CODE	5 X F	046	
SEREFNEA	SUPPORT EQUIPMENT REFERENCE NUMBER	32 X L	337	
UUTFA1UH	UUT FIRU AMBIGUITY GROUP 1	2 N R	143	
UUTFA2UH	UUT FIRU AMBIGUITY GROUP 2	2 N R	143	
UUTFP1UH	UUT FIRU PERCENT FAILURE 1	3 N R 1	143	
UUTFP2UH	UUT FIRU PERCENT FAILURE 2	3 N R 1	143	
UUTFTDUH	UUT FIRU TEST REQUIREMENTS DOCUMENT INDICATOR	1 A F	447	

MIL-STD-1388-2B
APPENDIX A

90.9 Table UI, Adapter Interconnector Device. This table contains pricing and identification information about items which are utilized to interface the UUT with the SE. The table keys are migrated from table HA and given the role names Adapter Interconnector Device (AID) Reference Number (AIDREFUI) and AID CAGE Code (AIDCAGUI).

<u>CODE</u>	<u>DATA ELEMENT TITLE</u>	<u>FORMAT</u>	<u>DED</u>	<u>KEY</u>
AIDCAGUI	ADAPTER INTERCONNECTOR DEVICE (AID) CAGE CODE	5 X F	046	F
AIDREFUI	AID REFERENCE NUMBER	32 X L	337	F
AIDUCNUI	AID APPORTIONED UNIT COST NONRECURRING	8 N R	025	
AIDUCRUI	AID APPORTIONED UNIT COST RECURRING	8 N R	025	
AIDSRDUI	AID SUPPORT EQUIPMENT RECOMMENDATION DATA NUMBER	10 X F	416	
AIDCUTUI	AID COMMON UNIT UNDER TEST	2 N R	048	

90.10 Table UJ, Unit Under Test Support Equipment Adapter Interconnector Device. This table cross-references data pertaining to the relationship between the SE, AID, and the UUT. Table keys include the CAGE and Reference Number for the AID (AIDCAGUI and AIDREFUI, respectively) from table UI and the keys migrated from table UB which are EIAC (EIACODXA), UUT LCN (UUTLCNUA), UUT ALC (UUTALCUA), UUT LCN Type (UTLCNTUA), SE Reference Number (SEREFNEA), and SE CAGE Code (SECAGEEA).

<u>CODE</u>	<u>DATA ELEMENT TITLE</u>	<u>FORMAT</u>	<u>DED</u>	<u>KEY</u>
EIACODXA	END ITEM ACRONYM CODE	10 X L -	096	F
UUTLCNUA	UUT LSA CONTROL NUMBER (LCN)	18 X L -	199	F
UUTALCUA	UUT ALTERNATE LCN CODE	2 N F -	019	F
UTLCNTUA	UUT LCN TYPE	1 A F -	203	F
SECAGEEA	SUPPORT EQUIPMENT CAGE CODE	5 X F	046	F
SEREFNEA	SUPPORT EQUIPMENT REFERENCE NUMBER	32 X L	337	F
AIDCAGUI	ADAPTER INTERCONNECTOR DEVICE (AID) CAGE CODE	5 X F	046	F
AIDREFUI	AID REFERENCE NUMBER	32 X L	337	F

90.11 Table UK, Automatic Test Equipment Test Station. This table is used to document identification and government designator information concerning the Automatic Test Equipment (ATE) Test Station required on a SERD summary. Table keys are migrated from table HA and given role names of ATE Reference Number (ATEREFUK) and ATE CAGE Code (ATECAGUK).

<u>CODE</u>	<u>DATA ELEMENT TITLE</u>	<u>FORMAT</u>	<u>DED</u>	<u>KEY</u>
ATECAGUK	ATE CAGE CODE	5 X F -	046	F
ATEREFUK	AUTOMATIC TEST EQUIPMENT (ATE) REFERENCE NUMBER	32 X L	337	F
ATEGDSUK	ATE GOVERNMENT DESIGNATOR	20 X L -	149	

MIL-STD-1388-2B
APPENDIX A

90.12 Table UL, Unit Under Test Support Equipment Automatic Test Equipment. This table cross-references the ATE Test Station (table UK) data with the UUT SE (table UB). Table keys are ATE Reference Number (ATEREFUK) and ATE CAGE Code (ATECAGUK) migrated from table UK and the keys migrated from table UB which are EIAC (EIACODXA), UUT LCN (UUTLCNUA), UUT ALC (UUTALCUA), UUT LCN Type (UTLCNTUA), SE Reference Number (SEREFNEA), and SE CAGE Code (SECAGEEA).

<u>CODE</u>	<u>DATA ELEMENT TITLE</u>	<u>FORMAT</u>	<u>DED</u>	<u>KEY</u>
EIACODXA	END ITEM ACRONYM CODE	10 X L -	096	F
UUTLCNUA	UUT LSA CONTROL NUMBER (LCN)	18 X L -	199	F
UUTALCUA	UUT ALTERNATE LCN CODE	2 N F -	019	F
UTLCNTUA	UUT LCN TYPE	1 A F -	203	F
SECAGEEA	SUPPORT EQUIPMENT CAGE CODE	5 X F	046	F
SEREFNEA	SUPPORT EQUIPMENT REFERENCE NUMBER	32 X L	337	F
ATECAGUK	ATE CAGE CODE	5 X F -	046	F
ATEREFUK	AUTOMATIC TEST EQUIPMENT (ATE) REFERENCE NUMBER	32 X L	337	F

90.13 Table UM, Support Equipment Item Unit Under Test. This table identifies pieces of SE (Calibration and Measurement Requirement Summary (CMRS) category II items) that are linked with CMRS category III items (SE in support of the category II SE). Normally, Tables UM and UN are only used if a CMRS (LSA-076) is required on contract. Table keys are migrated down from the EA table (Support Equipment) and given a role name of Support Equipment Unit Under Test to distinguish them (SUTCAGUM and SUTREFUM).

<u>CODE</u>	<u>DATA ELEMENT TITLE</u>	<u>FORMAT</u>	<u>DED</u>	<u>KEY</u>
SUTCAGUM	SUPPORT EQUIPMENT UNIT UNDER TEST (SE UUT) CAGE CODE	5 X F	046	F
SUTREFUM	SE UUT REFERENCE NUMBER	32 X L	337	F
SUTALLUM	SE UUT ALLOWANCE	10 X L	016	
SUTSTCUM	SE UUT CMRS STATUS	1 A F	036	
MNTPLNUM	SE UUT MAINTENANCE PLAN NUMBER	23 X L	209	
TRDNUMUM	SE UUT TEST REQUIREMENTS DOCUMENT NUMBER	15 X L	448	
WKPKRFUM	SE UUT WORK PACKAGE REFERENCE	6 X L	515	

90.14 Table UN, Support Equipment Unit Under Test Parameter Group. This table allows documenting specific information about individual parameters which a piece of support equipment (SE) (CMRS category II) requires to have calibrated, measured, etc. by another piece of SE (CMRS category III item). Data from this table will be used on the CMRS report (LSA-076). Table keys include the SE UUT Parameter Group Code (SEUPGCUN), keys migrated from table EA and given role names of "Testing" (TGSCAGUN and TGSREFUN), and keys from table UM are also migrated into this table (SUTREFUM and SUTCAGUM).

NOTE: The SE UUT Parameter Grouping Code (SEUPGCUN) and the SE Parameter Grouping Code (PARGPCEC) (table EC) provide the link between the parameters of CMRS category III items and category II items, respectively. Therefore,

MIL-STD-1388-2B
APPENDIX A

the values for PARGPEC and SEUPGCUN must be identical to link the SE UUT to the corresponding piece of testing SE.

<u>CODE</u>	<u>DATA ELEMENT TITLE</u>	<u>FORMAT</u>	<u>DED</u>	<u>KEY</u>
TGSCAGUN	TESTING SUPPORT EQUIPMENT (SE) CAGE CODE	5 X F -	046	F
TGSREFUN	TESTING SE REFERENCE NUMBER	32 X L -	337	F
SUTCAGUM	SE UNIT UNDER TEST (UUT) CAGE CODE	5 X F -	046	F
SUTREFUM	SE UUT REFERENCE NUMBER	32 X L -	337	F
SEUPGCUN	SE UUT PARAMETER GROUP CODE	2 A F -	284	K
UTPACMUN	SE UUT CALIBRATION MEASUREMENT REQUIREMENTS SUMMARY (CMRS) PARAMETER CODE	1 A F	034	
UTPAACUN	SE UUT PARAMETER ACCURACY	26 X L	284	
UTPAIOUN	SE UUT PARAMETER INPUT/OUTPUT CODE	1 A F	284	
UTPAPAUN	SE UUT PARAMETER	12 X L	284	
UTRGFRUN	SE UUT PARAMETER RANGE FROM	10 D - -	284	
UTPRRTUN	SE UUT PARAMETER RANGE TO	10 D - -	284	
UTPARVUN	SE UUT PARAMETER RANGE/VALUE CODE	1 A F	284	
UTPATAUN	SE UUT PARAMETER TEST ACCURACY RATIO (TAR) ACTUAL	1 X F	442	
UTPATDUN	SE UUT PARAMETER TAR DESIRED	1 X F	442	

MIL-STD-1388-2B
APPENDIX A

100. FACILITIES CONSIDERATIONS. Data tables beginning with "F" in the first position of the table code are structured to describe and justify all proposed special and additional facilities requirements, which are indicated as a result of the operational/maintenance task analysis. Figure 10 depicts the relational hierarchy of these tables/entities.

<u>TABLE CODE</u>	<u>TABLE TITLE</u>
FA	Facility
FB	Facility Narrative
FC	Baseline Facility Narrative
FD	New or Modified Facility Narrative
FE	Operations and Maintenance Task Facility Requirement

100.1 Table FA, Facility. This table identifies the facility by name, category code, and type that the system/equipment under analysis requires. The table keys are Facility Name (FACNAMFA), Facility Category Code (FACCCDFA), and Facility Type (FACTYPFA). For a given row of information, the following cross-element edits apply to table FB:

a. Facility Area (FAAREAFA) and Facility Area UM (FAARUMFA) must either both be blank, or both have entries.

b. Facility Construction Unit of Measure Price (FACNCOFA) and Construction Unit of Measure (CONUOMFA) must either both be blank, or both have entries.

<u>CODE</u>	<u>DATA ELEMENT TITLE</u>	<u>FORMAT</u>	<u>DED</u>	<u>KEY</u>
FACNAMFA	FACILITY NAME	32 X L -	118	K
FACCCDFA	FACILITY CATEGORY CODE	6 N L -	115	K
FACTYPFA	FACILITY TYPE	1 A F -	483	K
FACCLAFA	FACILITY CLASS	19 X L -	116	
DRCLASFA	FACILITY DRAWING CLASSIFICATION	3 X - -	088	
FADNUMFA	FACILITY DRAWING NUMBER	32 X L -	089	
FADREVFA	FACILITY DRAWING REVISION	2 A R -	360	
FAAREAFA	FACILITY AREA	6 N R -	112	
FAARUMFA	FACILITY AREA UNIT OF MEASURE	2 A F -	491	
FACNCOFA	FACILITY CONSTRUCTION UNIT OF MEASURE PRICE	10 NR 2 -	492	
CONUOMFA	CONSTRUCTION UNIT OF MEASURE	2 A F -	491	

100.2 Table FB, Facility Narrative. This table may be used to identify Facility Capability, and Facility Location of either the baseline facility or the new or modified facility. The table keys consist of Facility Name (FACNAMFA), Facility Category Code (FACCCDFA), Facility Type (FACTYPFA), Facility Narrative Code (FNCOFEFB), and Facility Narrative Text Sequencing Code (TEXSEQFB). For a given row of information, the following cross-element edits apply to table FB:

a. If the Facility Narrative Code (FNCOFEFB) is (A), then this table identifies the capacity impact on the work load of the facility (Facility

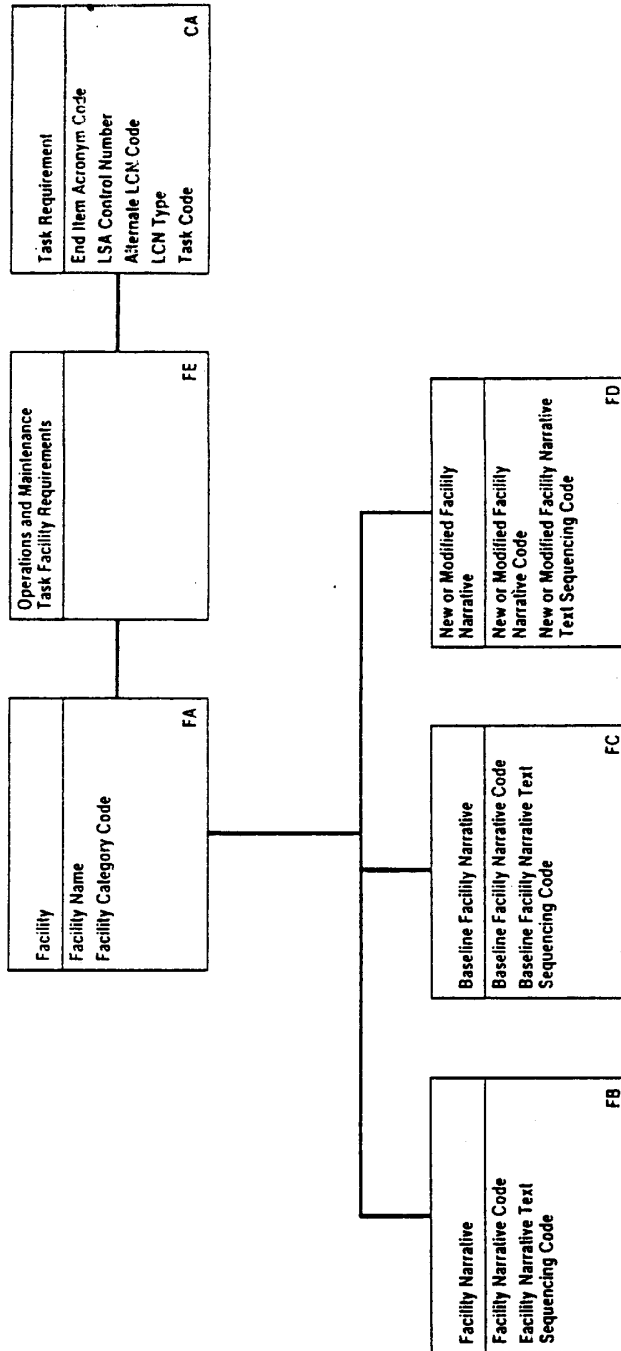

MIL-STD-1388-2B
APPENDIX A

Capability, DED 114).

b. If the Facility Narrative Code (FNCODEFB) is (B), then this table identifies the existing depot facility in terms of where the facility is located (e.g., depot name, building, bay, etc.) (Facility Location, DED 117).

<u>CODE</u>	<u>DATA ELEMENT TITLE</u>	<u>FORMAT</u>	<u>DED</u>	<u>KEY</u>
FACNAMFA	FACILITY NAME	32 X L -	118	F
FACCCDFA	FACILITY CATEGORY CODE	6 N L -	115	F
FACTYPFA	FACILITY TYPE	1 A F -	483	F
FNCODEFB	FACILITY NARRATIVE CODE	1 A F -	119	K
TEXSEQFB	FACILITY NARRATIVE TEXT SEQUENCING CODE	5 N R -	450	K
FACNARFB	FACILITY NARRATIVE	65 X - -	---	

100.3 Table FC, Baseline Facility Narrative. This table may be used to identify Facility Maintenance Requirements, Facility Requirements for Operations, Facility Training Requirement, Facility Requirements Special Considerations, and Facility Requirements Supply and Storage for a baseline facility. Baseline is describing the requirements needed for a facility, this applies to both an existing facility and a new or modified facility. The table keys consist of Baseline Facility Name (FACNAMFC), Baseline Facility Category Code (FACCCDFC), Baseline Facility Type (FACTYPFC), Baseline Facility Narrative Code (FBNACDFC), and Baseline Facility Narrative Text Sequencing Code (TEXSEQFC). For a given row of information, the following cross-element edits apply to table FC:

a. If Baseline Facility Narrative Code (FBNACDFC) is (A), then this table identifies the maintenance concept for the system/equipment under analysis and the facilities that are required to maintain the system (Facilities Maintenance Requirement, DED 107).

b. If Baseline Facility Narrative Code (FBNACDFC) is (B), then this table identifies what facilities are needed to support the system in its daily use (Facilities Requirements For Operations, DED 109).

c. If Baseline Facility Narrative Code (FBNACDFC) is (C), then this table identifies what facilities are needed for training (Facilities Requirement for Training, DED 110).

d. If Baseline Facility Narrative Code (FBNACDFC) is (D), then this table describes any special considerations which impact facility requirements (Facility Requirements Special Considerations, DED 120).

e. If Baseline Facility Narrative Code (FBNACDFC) is (E), then this table describes where the system/equipment will be stored, or if there is an impact in other storage facilities (Facility Requirements Supply/Storage, DED 121).

<u>CODE</u>	<u>DATA ELEMENT TITLE</u>	<u>FORMAT</u>	<u>DED</u>	<u>KEY</u>
FACNAMFC	BASELINE FACILITY NAME	32 X L -	118	F
FACCCDFC	BASELINE FACILITY CATEGORY CODE	6 N L -	115	F
FACTYPFC	BASELINE FACILITY TYPE	1 A F -	483	F
FBNACDFC	BASELINE FACILITY NARRATIVE CODE	1 A F -	113	K

MIL-STD-1388-2B
APPENDIX A

TEXSEQFC	BASELINE FACILITY NARRATIVE TEXT SEQUENCING CODE	5 N R -	450	K
FABNARFC	BASELINE FACILITY NARRATIVE	65 X - -	---	

100.4 Table FD, New or Modified Facility Narrative. This table contains information about modifications of existing facilities or requirements for new facilities. This table may be used to identify Facility Design Criteria, Facility Installation Lead Time, Facility Task Area Breakdown, Facility Utilization, Facility Requirements, Facility Unit Cost Rationale, Facility Justification, Type of Construction, and Utilities Requirement. The table keys consist of New or Modified Facility Name (FACNAMFD), New or Modified Facility Category Code (FACCCDFD), New or Modified Facility Type (FACTYPFD) New or Modified Facility Narrative Code (NMFNCDFD), and Text Sequencing Code (TEXSEQFD). For a given row of information, the following cross-element edits apply to table FD:

a. If the New or Modified Facility Narrative Code (NMFNCDFD) is (A), then this table describes the facility design requirements necessary to support the item under analysis (Facility Design Criteria, DED 105).

b. If the New or Modified Facility Narrative Code (NMFNCDFD) is (B), then this table describes the facilities installation lead time schedules for contractor produced and installed support, test equipment, and training devices (Facility Installation Lead Time, DED 106).

c. If the New or Modified Facility Narrative Code (NMFNCDFD) is (C), then this is a narrative description identifying the breakdown of a new or modified facility for the area by individual tasks at the job level to determine maximum use of space (Facility Task Area Breakdown, DED 122).

d. If the New or Modified Facility Narrative Code (NMFNCDFD) is (D), then this is a table describing the new or modified facility utilization rate (Facilities Utilization, DED 111).

e. If the New or Modified Facility Narrative Code (NMFNCDFD) is (E), then this table describes the location of and the functions to be performed at the new or modified facility (Facilities Requirements, DED 108).

f. If the New or Modified Facility Narrative Code (NMFNCDFD) is (F), then this is a narrative field identifying variations to the appropriate unit cost contained in the military construction guides (Facility Unit Cost Rationale, DED 123).

g. If the New or Modified Facility Narrative Code (NMFNCDFD) is (G), then this is a narrative field which identifies the major factors which led to the decision that a new facility was required (Facility Justification, DED 188).

h. If the New or Modified Facility Narrative Code (NMFNCDFD) is (H), then this table describes what type of construction is required at a new or modified facility (Type of Construction, DED 482).

i. If the New or Modified Facility Narrative Code (NMFNCDFD) is (I), then this is a narrative description identifying an estimate of the utilization required for a new or modified facility (Utilities Requirement, DED 502).

MIL-STD-1388-2B
APPENDIX A

<u>CODE</u>	<u>DATA ELEMENT TITLE</u>	<u>FORMAT</u>	<u>DED</u>	<u>KEY</u>
FACNAMFD	NEW OR MODIFIED FACILITY NAME	32 X L -	118	F
FACCCDFD	NEW OR MODIFIED FACILITY CATEGORY CODE	6 N L -	115	F
FACTYPFD	NEW OR MODIFIED FACILITY TYPE	1 A F -	483	F
NMFNCDFD	NEW OR MODIFIED FACILITY NARRATIVE CODE	1 A F -	255	K
TEXSEQFD	NEW OR MODIFIED FACILITY NARRATIVE TEXT SEQUENCING CODE	5 N R -	450	K
NMFNARFD	NEW OR MODIFIED FACILITY NARRATIVE	65 X - -	---	

100.5 Table FE, Operations and Maintenance Task Facility Requirement. This table identifies a need for operations/maintenance facilities for a given task. The table keys consist of EIAC (EIACODXA), LCN (LCNCODXB), ALC (ALTLCNXB), LCN Type (LCNTYPXB), Facility Name (FACNAMFA), Facility Category Code (FACCCDFA), Facility Type (FACTYPFA), and Task Code (TASKCDCA).

<u>CODE</u>	<u>DATA ELEMENT TITLE</u>	<u>FORMAT</u>	<u>DED</u>	<u>KEY</u>
EIACODXA	END ITEM ACRONYM CODE	10 X L -	096	F
LSACONXB	LSA CONTROL NUMBER (LCN)	18 X L -	199	F
ALTLCNXB	ALTERNATE LCN CODE	2 N F -	019	F
LCNTYPXB	LCN TYPE	1 A F -	203	F
TASKCDCA	TASK CODE	7 X F -	427	F
FACNAMFA	FACILITY NAME	32 X L -	118	F
FACCCDFA	FACILITY CATEGORY CODE	6 N L -	115	F
FACTYPFA	FACILITY TYPE	1 A F -	483	F

MIL-STD-1388-2B
APPENDIX A

110. PERSONNEL SKILL CONSIDERATIONS. Data tables beginning with "G" in the first position of the table code are structured to describe and justify any new or modified personnel skills required to support the system/equipment. Figure 11 depicts the relational hierarchy of these tables/entities.

<u>TABLE CODE</u>	<u>TABLE TITLE</u>
GA	Skill Specialty
GB	New or Modified Skill
GC	New or Modified Skill Narrative
GD	Skill Aptitude Data
GE	Physical and Mental Requirements Narrative

110.1 Table GA, Skill Specialty. This table contains information about military and civilian skill specialties. The table key is SSC (SKSPCDGA). For a given row, Hour Labor Rate (HRLARTGA) is per SSC (SKSPCDGA).

<u>CODE</u>	<u>DATA ELEMENT TITLE</u>	<u>FORMAT</u>	<u>DED</u>	<u>KEY</u>
SKSPCDGA	SKILL SPECIALTY CODE	7 X L -	387	K
SKLVCDGA	SKILL LEVEL CODE	1 A F -	386	
HRLARTGA	HOURLY LABOR RATE	4 N R 2	161	
TRNCOSGA	TRAINING COST	7 N R 2	460	

110.2 Table GB, New or Modified Skill. This table contains information about new or modified skill requirements. The key for this table is New or Modified SSC (MDCSSCGB). For a given row of information, the following cross-element edits apply to table GB:

a. SSC (SKSPCDGA) is migrated into this table as nonidentifying key which means that this key is not required to uniquely identify an instance of the entity.

b. A Security Clearance (SCRSSCGB) is required for each New or Modified SSC (MDCSSCGB).

c. ASVAB AFQT Expected Range Low (AAEXRLGB) and High (AAEXRHGB) are required for each ASVAB AFQT Score (ABAFQTGB).

d. ASVAB AFQT Lowest Percent Low (AALPRLGB) and High (AALPRHGB) are required for each ASVAB AFQT Score (ABAFQTGB).

<u>CODE</u>	<u>DATA ELEMENT TITLE</u>	<u>FORMAT</u>	<u>DED</u>	<u>KEY</u>
MDCSSCGB	NEW OR MODIFIED SKILL SPECIALTY CODE	7 X L -	257	K
MDSCLCGB	NEW OR MODIFIED SKILL LEVEL CODE	1 A F -	386	
SKSPCDGA	SKILL SPECIALTY CODE	7 X L -	387	
DPRNRSGB	DUTY POSITION REQUIRING A NEW OR REVISED SKILL	19 X L -	092	

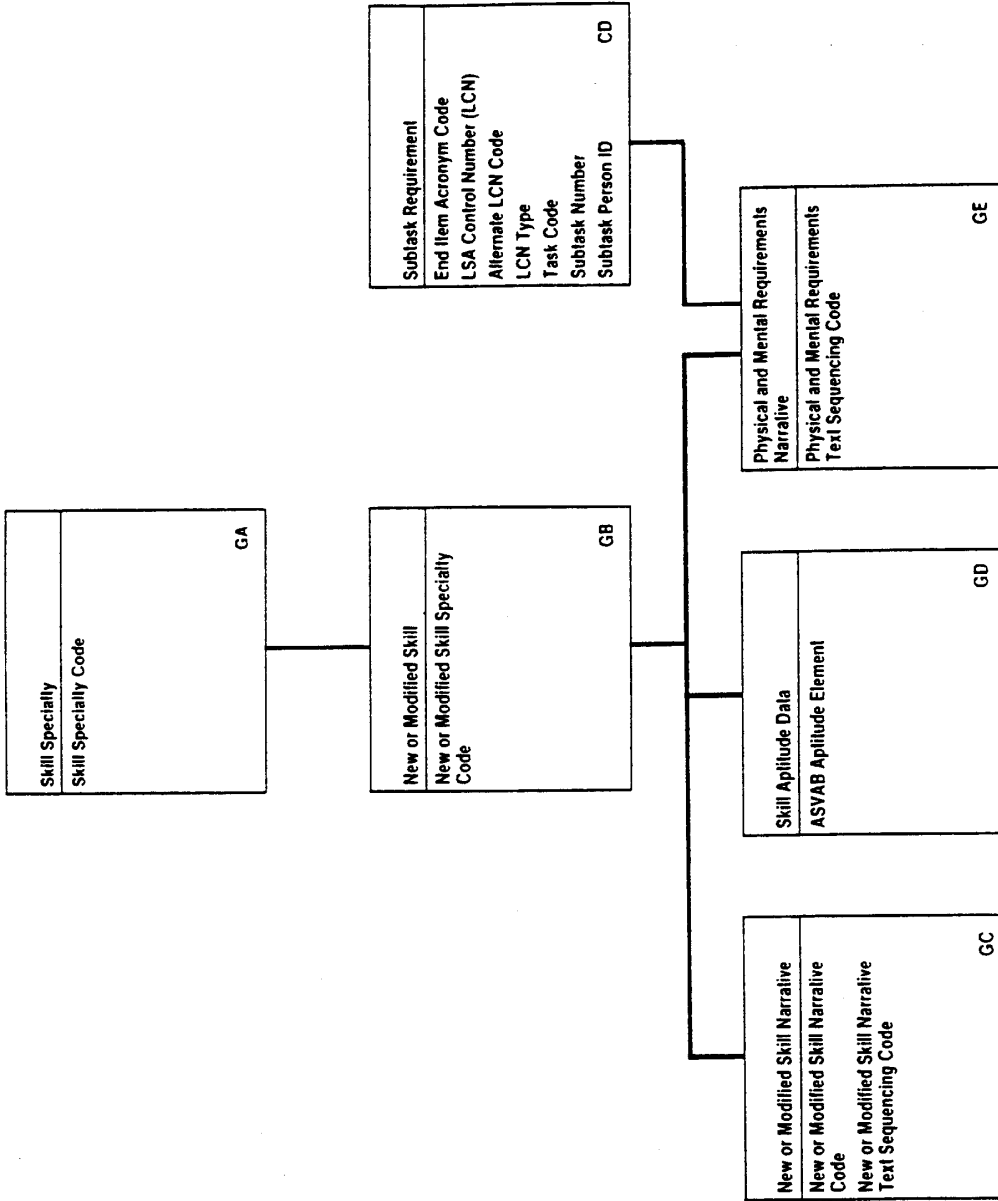

MIL-STD-1388-2B
APPENDIX A

RPPCIVGB	RECOMMENDED CIVILIAN GRADE	4 X F -	330
RPPMILGB	RECOMMENDED MILITARY RANK/RATE	3 X F -	330
SCRSSCGB	SECURITY CLEARANCE REQUIRED	1 N F -	369
SSCTESGB	TEST SCORE	3 N R -	449
ABAFQTGB	ARMED SERVICES VOCATIONAL APTITUDE BATTERY (ASVAB) ARMED FORCES QUALIFICATION TEST (AFQT) SCORE	2 N F-	026
AAEXRLGB	ASVAB AFQT EXPECTED RANGE LOW	2 N F -	026
AAEXRHGB	ASVAB AFQT EXPECTED RANGE HIGH	2 N F -	026
AALPRLGB	ASVAB AFQT LOWEST PERCENT-LOW	2 N F -	026
AALPRHGB	ASVAB AFQT LOWEST PERCENT-HIGH	2 N F -	026

110.3 Table GC, New or Modified Skill Narrative. This table may be used to identify New or Modified Skill Additional Requirements, Educational Qualifications, Skill Justification, and Additional Training Requirements. The table keys consist of New or Modified SSC (MDCSSCGB), New or Modified Skill Narrative Code (NMSNCDGC), and New or Modified Skill Narrative Text Sequencing Code (TEXSEQGC). For a given row of information, the following cross-element edits apply to table GC:

a. If the New or Modified Skill Narrative Code is (A), then this table describes the new skills that are required in order to operate and maintain the equipment under analysis (New or Modified Skill Additional Requirements, DED 007).

b. If the New or Modified Skill Narrative Code is (B), then this table describes the educational prerequisites recommended to acquire the skill necessary to perform the task (Educational Qualifications, DED 094).

c. If the New or Modified Skill Narrative Code is (C), then this table identifies the major factors which led to the decision that training is needed for the new or modified skill (Skill Justification, DED 188).

d. If the New or Modified Skill Narrative Code is (D), then this table describes the additional training required for maintenance, operator, and instructor personnel (Additional Training Requirements, DED 012).

<u>CODE</u>	<u>DATA ELEMENT TITLE</u>	<u>FORMAT</u>	<u>DED</u>	<u>KEY</u>
MDCSSCGB	NEW OR MODIFIED SKILL SPECIALTY CODE	7 X L -	257	F
NMSNCDGC	NEW OR MODIFIED SKILL NARRATIVE CODE	1 A F -	256	K
TEXSEQGC	NEW OR MODIFIED SKILL NARRATIVE TEXT SEQUENCING CODE	5 N R -	450	K
NMSNARGC	NEW OR MODIFIED SKILL NARRATIVE	65 X - -	---	

110.4 Table GD, Skill Aptitude Data. This table contains information about Armed Services Vocational Aptitude Battery scores. The table keys consist of New or Modified Skill Specialty Code (MDCSSCGB) and ASVAB Aptitude Element (ASVAPEGD).

a. ASVAB Aptitude Element Expected Range Low (AAEERLGD) and High

MIL-STD-1388-2B
APPENDIX A

(AAEERHGB) are required for each ASVAB Aptitude Element (ASVAPEGD).

b. ASVAB Aptitude Element Lowest Percent Low (AAELPLGD) and High (AAELPHGD) are required for each ASVAB Aptitude Element (ASVAPEGD).

<u>CODE</u>	<u>DATA ELEMENT TITLE</u>	<u>FORMAT</u>	<u>DED</u>	<u>KEY</u>
MDCSSCGB	NEW OR MODIFIED SKILL SPECIALTY CODE	7 X L -	257	F
ASVAPEGD	ASVAB APTITUDE ELEMENT	2 A R -	026	K
AAEERLGD	ASVAB APTITUDE ELEMENT EXPECTED RANGE-LOW	3 N F-	026	
AAEERHGD	ASVAB APTITUDE ELEMENT EXPECTED RANGE-HIGH	3 N F-	026	
AAELPLGD	ASVAB APTITUDE ELEMENT LOWEST PERCENT-LOW	3 N F-	026	
AAELPHGD	ASVAB APTITUDE ELEMENT LOWEST PERCENT-HIGH	3 N F-	026	

110.5 Table GE, Physical and Mental Requirements Narrative. This table contains information which identifies any unique physical/mental personnel attributes required or recommended as prerequisites to full qualification in the applicable task. The table keys consist of EIAC (EIACODXA), LCN (LCNCODXB), ALC (ALTLCNXB), LCN Type (LCNTYPXB), Task Code (TASKCDCA), Subtask Number (SUBNUMCB), Subtask Person Identifier (SUBPIDCD), New or Modified SSC (MDCSSCGB), and Physical and Mental Requirements Text Sequencing Code (TEXSEQGE).

<u>CODE</u>	<u>DATA ELEMENT TITLE</u>	<u>FORMAT</u>	<u>DED</u>	<u>KEY</u>
EIACODXA	END ITEM ACRONYM CODE	10 X L -	096	F
LSACONXB	LSA CONTROL NUMBER (LCN)	18 X L -	199	F
ALTLCNXB	ALTERNATE LCN CODE	2 N F -	019	F
LCNTYPXB	LCN TYPE	1 A F -	203	F
TASKCDCA	TASK CODE	7 X F -	427	F
SUBNUMCB	SUBTASK NUMBER	3 N F -	407	F
SUBPIDCD	SUBTASK PERSON IDENTIFIER	3 X L -	288	F
MDCSSCGB	NEW OR MODIFIED SKILL SPECIALTY CODE	7 X L -	257	F
TEXSEQGE	PHYSICAL AND MENTAL REQUIREMENTS TEXT SEQUENCING CODE	5 N R -	450	K
PAMENRGE	PHYSICAL AND MENTAL REQUIREMENTS NARRATIVE	65 X - -	290	

MIL-STD-1388-2B
APPENDIX A

120. PACKAGING AND PROVISIONING REQUIREMENT. The following "H" data tables are used to document packaging/provisioning data requirements. Included in these tables are static parts data (nonapplication dependent) related to provisioning screening and cataloging, packaging, and common maintenance data. Also included under these data tables are application data of items used to document the data required for initial support requirements determination, repair parts manuals, and design change information. Figure 12 depicts the data relationships for these tables.

<u>TABLE CODE</u>	<u>TABLE TITLE</u>
HA	Item Identification
HB	Additional Reference Number
HC	Contractor Technical Information Code CAGE
HD	Unit of Issue Price
HE	Unit of Measure Price
HF	Item Packaging Requirement
HG	Part Application Provisioning
HH	Overhaul-Kit Next Higher Assembly PLISN
HI	Provisioning Remark
HJ	Provisioning Reference Designation
HK	Parts Manual Description
HL	Parts Manual Provisioning Nomenclature
HM	Basis of Issue
HN	Provisioning Serial Number Usable On Code
HO	Provisioning System/End Item Usable On Code
HP	Design Change Information
HQ	Serial Number Effectivity
HR	Design Change Usable On Code

120.1 Table HA, Item Identification. This table contains parts information that is not dependent of the part application such as item identification, cataloging, common maintenance information, special management characteristics and units of measure and issue. Table keys consist of Reference Number and CAGE (REFNUMHA and CAGECDXH). For a given row of information, the following cross-element edits apply to table HA:

MIL-STD-1388-2B
APPENDIX A

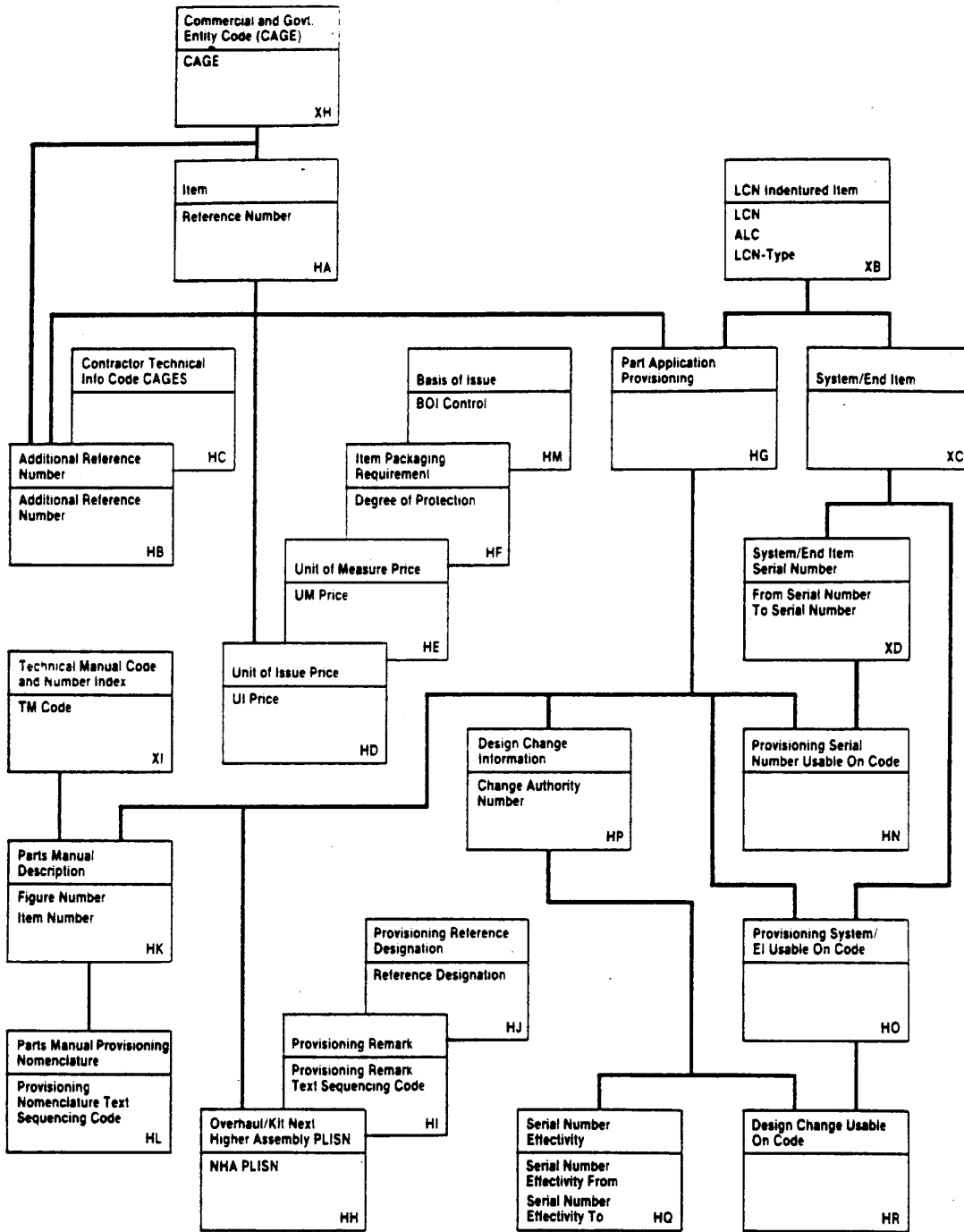

MIL-STD-1388-2B
APPENDIX A

- a. Acquisition Method Suffix Code (AMSUFCHA) is not allowed without Acquisition Method Code (ACQMETHA).
- b. Shelf Life Action Code (SLACTNHA) is not allowed without Shelf Life (SHLIFEHA).
- c. National Item Identification Number (NIINSNHA) is not allowed without Federal Supply Classification (FSCNSNHA).
- d. Unit Length (ULENGTHA), Width (UWIDTHHA), and Height (UHEIGHTHA) must either be all blank or all have entries.
- e. If UM (UNITMSHA) equals UI (UNITISHA), UI Conversion Factor (UICONVHA) must equal "00001". Conversely, if UI and UM are not equal, then UI Conversion Factor cannot equal "00001".
- f. If Special Material Content Code (SPMACCHA) is "E", then the Precious Metals Indicator Code (PMICODHA) cannot be "A".
- g. Material Leadtime (MTLEADHA) and Material Weight (MTLWGTHA) are not allowed without Industrial Materials Analysis of Capacity (INDMATHA).

<u>CODE</u>	<u>DATA ELEMENT TITLE</u>	<u>FORMAT</u>	<u>DED</u>	<u>KEY</u>
CAGECDXH	CAGE CODE	5 X F -	046	F
REFNUMHA	REFERENCE NUMBER	32 X L -	337	K
ITNAMEHA	ITEM NAME	19 X L -	182	
INAMECHA	ITEM NAME CODE	5 N F -	183	
REFNCCHA	REFERENCE NUMBER CATEGORY CODE	1 X F -	338	
REFNVCHA	REFERENCE NUMBER VARIATION CODE	1 N F -	339	
DLSCRCHA	DLSC SCREENING REQUIREMENT CODE	1 A F -	073	
DOCIDCHA	DOCUMENT IDENTIFIER CODE	3 A F -	087	
ITMMGCHA	ITEM MANAGEMENT CODE	1 A F -	181	
COGNSNHA	NATIONAL STOCK NUMBER (NSN) COGNIZANCE CODE	2 X F -	253	
SMMNSNHA	NSN SPECIAL MATERIAL IDENTIFICA- TION CODE/MATERIEL MANAGEMENT AGGREGATION CODE	2 X F -	253	
MATNSNHA	NSN MATERIEL CONTROL CODE	1 X F -	253	
FSCNSNHA	NSN FEDERAL SUPPLY CLASSIFICATION	4 N F -	253	
NIINSNHA	NSN NATIONAL ITEM IDENTIFICATION NUMBER	9 X F -	253	
ACTNSNHA	NSN ACTIVITY CODE	2 X F -	253	
UICONVHA	UNIT OF ISSUE CONVERSION FACTOR	5 N F -	489	
SHLIFEHA	SHELF LIFE	1 X F -	377	
SLACTNHA	SHELF LIFE ACTION CODE	2 X F -	378	
PPLSTHA	PROGRAM PARTS SELECTION LIST	1 A F -	302	
DOCAVCHA	DOCUMENT AVAILABILITY CODE	1 X F -	086	
PRDLTHA	PRODUCTION LEAD TIME	2 N R -	299	
SPMACCHA	SPECIAL MATERIAL CONTENT CODE	1 X F -	395	
SMAINCHA	SPECIAL MAINTENANCE ITEM CODE	1 A F -	392	
CRITCDHA	CRITICALITY CODE	1 A F -	066	
PMICODHA	PRECIOUS METAL INDICATOR CODE	1 X F -	293	
SAIPCDHA	SPARES ACQUISITION INTEGRATED WITH PRODUCTION	1 A F -	391	

MIL-STD-1388-2B
APPENDIX A

AAPLCCHA	GOVERNMENT FURNISHED PROVISIONING LIST CATEGORY CODE (PLCC)	1 A F -	308
BBPLCCHA	INTERIM SUPPORT ITEMS PLCC	1 A F -	308
CCPLCCHA	LONG LEAD TIME ITEM PLCC	1 A F -	308
DDPLCCHA	TOOLS AND TEST EQUIPMENT PLCC	1 A F -	308
EEPLCCHA	COMMON AND BULK ITEM PLCC	1 A F -	308
FFPLCCHA	REPAIRABLE ITEMS PLCC	1 A F -	308
GGPLCCHA	INTERIM RELEASED ITEM PLCC	1 A F -	308
HHPLCCHA	INSTALLATION AND CHECKOUT ITEM PLCC	1 A F -	308
JJPLCCHA	AUTHORIZATION STOCK LIST ITEM PLCC	1 A F -	308
KKPLCCHA	RECOMMENDED BUY LIST ITEM PLCC	1 A F -	308
LLPLCCHA	PRESCRIBED LOAD LIST ITEM PLCC	1 A F -	308
MMPLCCHA	SYSTEM SUPPORT PACKAGE COMPONENT LIST PLCC	1 A F -	308
PHYSECHA	PHYSICAL SECURITY PILFERAGE CODE	1 X F -	291
ADPEQPHA	ADP EQUIPMENT CODE	1 N F -	027
DEMILIIHA	DEMILITARIZATION CODE	1 X F -	076
ACQMETHA	ACQUISITION METHOD CODE	1 N F -	003
AMSUFCHA	ACQUISITION METHOD SUFFIX CODE	1 X F -	004
HMSCOSHA	HAZARDOUS MATERIALS STORAGE COST	8 N R -	156
HWDCOSHA	HAZARDOUS WASTE DISPOSAL COST	8 N R -	157
HWSCOSHA	HAZARDOUS WASTE STORAGE COST	8 N R -	158
CTICODHA	CONTRACTOR TECHNICAL INFORMATION CODE	2 A - -	058
UWEIGHHA	UNIT WEIGHT	5 X - -	497
ULENGTHA	UNIT SIZE LENGTH	4 N R 1	496
UWIDTHHA	UNIT SIZE WIDTH	4 N R 1	496
UHEIGHHA	UNIT SIZE HEIGHT	4 N R 1	496
HAZCODHA	HAZARDOUS CODE	1 A F -	154
UNITMSHA	UNIT OF MEASURE	2 A F -	491
UNITISHA	UNIT OF ISSUE	2 A F -	488
LINNUMHA	LINE ITEM NUMBER	6 X L -	193
CRITITHA	CRITICAL ITEM CODE	13 X L -	065
INDMATHA	INDUSTRIAL MATERIALS ANALYSIS OF CAPACITY	19 X L -	163
MTLEADHA	MATERIAL LEADTIME	3 N R -	219
MTLWGTHA	MATERIAL WEIGHT	6 N R 3	220
MATERLHA	MATERIAL	240 X L -	218

120.2 Table HB, Additional Reference Number. This table contains Additional Reference Numbers (ARN) that may be used to identify the item of supply. Table keys include item Reference Number (REFNUMHB) and CAGE (CAGECDHB) from table HA, additional CAGE (ADCAGEHB) from table XH, and ARN (ADDREFHB). In a given row, when the ARN and CAGE match the primary Reference Number and CAGE, there must be an entry in Reference Number Category Code (RNCC) and this entry must be different from the RNCC entry in table HA.

<u>CODE</u>	<u>DATA ELEMENT TITLE</u>	<u>FORMAT</u>	<u>DED</u>	<u>KEY</u>
CAGECDHB	ARN ITEM CAGE CODE	5 X F -	046	F
REFNUMHB	ARN ITEM REFERENCE NUMBER	32 X L -	337	F
ADCAGEHB	ARN CAGE CODE	5 X L -	046	F
ADDREFHB	ADDITIONAL REFERENCE NUMBER	32 X L -	006	K

MIL-STD-1388-2B
APPENDIX A

ADRNCCHB	ARN REFERENCE NUMBER CATEGORY CODE	1 X F -	338
ADRNVCHB	ARN REFERENCE NUMBER VARIATION CODE	1 N F -	339

120.3 Table HC, Contractor Technical Information Code (CTIC) CAGE. This table contains CTIC CAGES. Table keys include: item reference number (REFNUMHC), and CAGE, (CAGECDHC) from table HA, and CTIC CAGE (CTCAGEHC) from table XH. CTIC (CTICODHA) must be established in Table HA with values of either "-K", "-M", or "-N" for the reference number and CAGE combination, prior to establishing a value in this table.

<u>CODE</u>	<u>DATA ELEMENT TITLE</u>	<u>FORMAT</u>	<u>DED</u>	<u>KEY</u>
CAGECDHC	ITEM CAGE CODE	5 X F -	046	F
REFNUMHC	ITEM REFERENCE NUMBER	32 X L -	337	F
CTCAGEHC	CTIC CAGE CODE	5 X F -	046	F

120.4 Table HD, Item Unit of Issue Price. This table contains UI prices and associated information about the UI price. Table keys include: Reference Number (REFNUMHA), CAGE (CAGECDXH), and UI Price (UIPRICHD).

a. UI (HA.UNITISHA) must be established in table HA for the Reference Number and CAGE combination prior to establishing a value in this table.

b. For identical Reference Number and CAGE keys, only one row of information can be established with a "Y" Provisioning UI Price Code (PROUIPHD).

c. Lot Quantity From (LOTQFMHD) must be less than or equal to Lot Quantity To (LOTQTOHD) in any row.

<u>CODE</u>	<u>DATA ELEMENT TITLE</u>	<u>FORMAT</u>	<u>DED</u>	<u>KEY</u>
CAGECDXH	CAGE CODE	5 X F -	046	F
REFNUMHA	REFERENCE NUMBER	32 X L -	337	F
UIPRICHD	UNIT OF ISSUE (UI) PRICE	10 N R 2	490	K
LOTQFMHD	UI PRICE LOT QUANTITY FROM	6 N R -	205	
LOTQTOHD	UI PRICE LOT QUANTITY TO	6 N R -	205	
CURPRCHD	UI PRICE CONCURRENT PRODUCTION CODE	1 A F -	051	
TUIPRCHD	UI PRICE TYPE OF PRICE CODE	1 A F -	485	
PROUIPHD	UI PRICE PROVISIONING	1 A F -	314	
FISCYRHD	UI PRICE FISCAL YEAR	2 N F -	145	

120.5 Table HE, Item Unit of Measure Price. This table contains UM prices and associated information about the UM price. Table keys include: Reference Number (REFNUMHA); CAGE (CAGECDXH); and, UM Price (UMPRICHE).

a. UM (HA.UNITMSHA) must be established in table HA for the Reference Number and CAGE combination prior to establishing a value in this table.

MIL-STD-1388-2B
APPENDIX A

b. For identical Reference Number and CAGE keys, only one row of information can be established with a "Y" Provisioning UM Price Code (PROUMPHE).

c. Lot Quantity From (LOTQFMHE) must be less than or equal to Lot Quantity To (LOTQTOHE) in any row.

<u>CODE</u>	<u>DATA ELEMENT TITLE</u>	<u>FORMAT</u>	<u>DED</u>	<u>KEY</u>
CAGECDXH	CAGE CODE	5 X F -	046	F
REFNUMHA	REFERENCE NUMBER	32 X L -	337	F
UMPRICHE	UNIT OF MEASURE (UM) PRICE	10 N R 2	492	K
LOTQFMHE	UM PRICE LOT QUANTITY FROM	6 N R -	205	
LOTQTOHE	UM PRICE LOT QUANTITY TO	6 N R -	205	
CURPRCHE	UM PRICE CONCURRENT PRODUCTION CODE	1 A F -	051	
TUMPRCHE	UM PRICE TYPE OF PRICE CODE	1 A F -	485	
PROUMPHE	UM PRICE PROVISIONING	1 A F -	314	
FISCYRHE	UM PRICE FISCAL YEAR	2 N F -	145	

120.6 Table HF, Item Packaging Requirement. This table contains packaging data, as specified by MIL-STD-2073-1 and MIL-STD-2073-2. Table keys are: Reference Number (REFNUMHA); CAGE (CAGECDXH); and, Degree of Protection (DEGPROHF).

a. Unit Pack Length (LENUPKHF), Width (WIDUPKHF), and Depth (DEPUPKHF) must either all be blank or all have entries for a row of information.

b. Unit Pack entries must be greater than or equal to Unit Size entries in table HA (LENUPKHF greater than or equal to ULENGTHA; WIDUPKHF greater than or equal to UWIDTHHA; and, DEPUPKHF greater than or equal to UHEIGHTHA).

c. For numeric entry, Unit Pack Weight (UNPKWTHF) must be greater than or equal to Unit Weight (UWEIGHTHA).

d. Packaging data preparer CAGE (PKCAGEHF) is a nonidentifying key migrating from table XH.

e. When packaging in accordance with special packaging instruction (SPI) enter code ZZ in the Method of Preservation Code (MEPRESHF) and omit entries in the following fields: Cleaning and Drying Procedures (CDPROCHF), Preservation Material Code (PRSMATHF), Wrapping Material (WRAPMTHF), Cushioning and Dunnage Material (CUSHMAHF), Cushioning Thickness (CUSTHIHF), and Unit Container (UNICONHF).

f. The Container National Stock Number (CONNSNHF) is the only the 4th-16th position of DED 253, National Stock Number and Related Data.

<u>CODE</u>	<u>DATA ELEMENT TITLE</u>	<u>FORMAT</u>	<u>DED</u>	<u>KEY</u>
CAGECDXH	CAGE CODE	5 X F -	046	F
REFNUMHA	REFERENCE NUMBER	32 X L -	337	F
DEGPROHF	DEGREE OF PROTECTION CODE	1 A F -	074	K
UNICONHF	UNIT CONTAINER CODE	2 X F -	486	
UCLEVLHF	UNIT CONTAINER LEVEL	1 X F -	487	

MIL-STD-1388-2B
APPENDIX A

PKGCODHF	PACKING CODE	3 X F -	283
PACCATHF	PACKAGING CATEGORY CODE	4 X F -	282
MEPRESHF	METHOD OF PRESERVATION CODE	2 X F -	239
CDPROCHF	CLEANING AND DRYING PROCEDURES	1 X F -	045
PRSMATHF	PRESERVATION MATERIAL CODE	2 X F -	295
WRAPMTHF	WRAPPING MATERIAL	2 X F -	517
CUSHMAHF	CUSHIONING AND DUNNAGE MATERIAL	2 X F -	067
CUSTHIHF	CUSHIONING THICKNESS	1 X F -	068
QTYUPKHF	QUANTITY PER UNIT PACK	3 X - -	321
INTCONHF	INTERMEDIATE CONTAINER CODE	2 X F -	174

THIS PAGE INTENTIONALLY LEFT BLANK

MIL-STD-1388-2B
APPENDIX A

INCQTYHF	INTERMEDIATE CONTAINER QUANTITY	3 X - -	175
SPEMRKHF	SPECIAL MARKING CODE	2 X F -	394
UNPKWTHF	UNIT PACK WEIGHT	5 X - -	495
LENUPKHF	UNIT PACK LENGTH	4 N R 1	494
WIDUPKHF	UNIT PACK WIDTH	4 N R 1	494
DEPUPKHF	UNIT PACK DEPTH	4 N R 1	494
UNPKCUHF	UNIT PACK CUBE	7 N R 3	493
OPTPRIHF	OPTIONAL PROCEDURES INDICATOR	1 X F -	279
SPINUMHF	SPECIAL PACKAGING INSTRUCTION (SPI) NUMBER	10 X L -	396
SPIREVHF	SPI NUMBER REVISION	1 A F -	397
SPDATEHF	SPI NUMBER JULIAN DATE	5 N L -	187
CONNSNHF	CONTAINER NATIONAL STOCK NUMBER	20 X - -	253
SUPPKDHF	SUPPLEMENTAL PACKAGING DATA	59 X L -	409
PKCAGEHF	PACKAGING DATA PREPARER CAGE	5 X F -	046

120.7 Table HG, Part Application Provisioning. This table contains parts related information to the part in a specific hardware application. Table keys include: Reference Number (REFNUMHA); CAGE (CAGECDXH); EIAC (EIACODXA); LCN (LSACONXB); ALC (ALTLCNXB); and, LCN Type (LCNTYPXB).

- a. LCN Type must always be "P" (Physical).
- b. Maintenance Action Code (MAIACHG) is not allowed without Maximum Allowable Operating Time (MAOTIMHG).
- c. Maintenance Task Distribution subfields (OMTDOOHG, FMTDFFHG, HMTDHHHG, LMTDLLHG, DMTDDDHG, CBDMTDHG, and CADMTDHG) must always total to 100 percent.
- d. Replacement Task Distribution subfields (ORTDOOHG, FRTDFFHG, HRTDHHHG, LRTDLLHG, and DRTDDDHG) must always total to 100 percent.
- e. PCCN (PCCNUMXC) and Provisioning List Item Sequence Number (PLISN) (PLISNOHG) combinations must be unique across all rows of information (PLISNs are mapped to respective PCCNs in Table XC through Table HO).
- f. Same as PLISN (SAPLISHG) must be contained in this table as a PLISN (PLISNOHG) having an identical PCCN. The same as PLISN must be the lowest (EBCDIC value) PLISN in the table for the same Reference Number, CAGE, and PCCN combinations (without an associated "D" TOCC).
- g. Repair Cycle Time (ORCTOOHG, FRCTFFHG, HRCTHHHG, LRCTLLHG, DRCTDDHG and CONRCTHG) for each Operations/Maintenance (O/M) Level (identified by the first position of the short name) must be either blank or greater for each higher O/M level. The O/M levels in ascending order are O, F, H, L, D, and CON (contractor).
- h. When numeric, the Quantity Per End Item (QTYPEIHG) must be greater than or equal to the Quantity Per Assembly (QTYASYHG).
- i. Maintenance Task Distribution and Replacement Task Distribution.
 - (1) OMTDOOHG must be less than or equal to ORTDOOHG.

MIL-STD-1388-2B
APPENDIX A

(2) OMTDOOHG and FMTDFFHG must be less than or equal to ORTDOOHG and FMTDFFHG.

(3) OMTDOOHG, FMTDFFHG, and HMTDHHHG must be less than or equal to ORTDOOHG, FRTDFFHG, and HRTDHHHG.

(4) OMTDOOHG, FMTDFFHG, HMTDHHHG, and LMTDLLHG must be less than or equal to ORTDOOHG, FRTDFFHG, HRTDHHHG, and LRTDLLHG.

(5) OMTDOOHG, FMTDFFHG, HMTDHHHG, LMTDLLHG, and DMTDDDHG must be less than or equal to ORTDOOHG, FRTDFFHG, HRTDHHHG, LRTDLLHG, and DRTDDDHG.

j. Maintenance Task Distribution and Repair Cycle Time (RCT). When OMTDOOHG, FMTDFFHG, HMTDHHHG, LMTDLLHG and DMTDDDHG have an entry, then the corresponding RCT O/M subfield (identified by the first position of the short name) must also have an entry (ORCTOOHG, FRCTFFHG, HRCTHHHG, LRCTLLHG, and DRCTDDHG).

k. An Allowance Item Quantity (ALIQTYHG) cannot be entered without an Allowance Item Code (ALLOWCHG).

l. When the Source, Maintenance, and Recoverability (SMR) (SMRCODHG) source code is "PC", the Shelf Life (SHLIFEHA) in table HA cannot be "0".

m. If the SMR (SMRCODHG) Source Code is "PB", then the Essentiality Code (ESSCODHG) cannot be "3".

n. If LRU (LRUNITHG) is "Y", then Essentiality Code (ESSCODHG) cannot be "3".

o. If the Special Maintenance Item Code (SMAINCHA) from table HA is "B", and if RCT has entries, then there must be an entry in the contractor RCT (CONRCTHG). If CONRCTHG is entered, then SMAINCHA can only be "B".

p. Maintenance Replacement Rate (MRR) I shall be calculated based on the Task Frequency (Table CA) and the Quantity per Task (Table CI). A change in any of these variables shall result in an update of the MRRI.

<u>CODE</u>	<u>DATA ELEMENT TITLE</u>	<u>FORMAT</u>	<u>DED</u>	<u>KEY</u>
CAGECDXH	CAGE CODE	5 X F -	046	F
REFNUMHA	REFERENCE NUMBER	32 X L -	337	F
EIACODXA	END ITEM ACRONYM CODE	10 X L -	096	F
LSACONXB	LSA CONTROL NUMBER (LCN)	18 X L -	199	F
ALTLCNXB	ALTERNATE LCN CODE	2 N F -	019	F
LCNTYPXB	LCN TYPE	1 A F -	203	F
PLISNOHG	PROVISIONING LIST ITEM SEQUENCE NUMBER (PLISN)	5 X L -	309	
QTYASYHG	QUANTITY PER ASSEMBLY	4 X - -	316	
SUPINDHG	SUPPRESSION INDICATOR	1 A F -	422	
DATASCHG	DATA STATUS CODE	1 A F -	070	
PROSICHG	PROVISIONING SYSTEM IDENTIFIER CODE	3 X L -	312	

MIL-STD-1388-2B
APPENDIX A

LLIPTDHG	LONG LEAD TIME ITEMS LIST (PROV- ISIONING TECHNICAL DOCUMENT- ATION SELECTION CODE (PTD))	1 A F -	313
PPLPTDHG	PROVISIONING PARTS LIST (PTD)	1 A F -	313
SFPPTDHG	SHORT FORM PROVISIONING PARTS LIST (PTD)	1 A F -	313
CBLPTDHG	COMMON AND BULK ITEMS LIST (PTD)	1 A F -	313
RILPTDHG	REPAIRABLE ITEMS LIST (PTD)	1 A F -	313
ISLPTDHG	INTERIM SUPPORT ITEMS LIST (PTD)	1 A F -	313
PCLPTDHG	POST CONFERENCE LIST (PTD)	1 A F -	313
TTLPTDHG	TOOL AND TEST EQUIPMENT LIST (PTD)	1 A F -	313
SCPPTDHG	SYSTEM CONFIGURATION PROVISIONING PARTS LIST (PTD)	1 A F -	313
ARAPTDHG	AS REQUIRED LIST A (PTD)	1 A F -	313
ARBPTDHG	AS REQUIRED LIST B (PTD)	1 A F -	313
TOCCODHG	TYPE OF CHANGE CODE	1 A F -	481
INDCODHG	INDENTURE CODE	1 X F -	162
QTYPEIHG	QUANTITY PER END ITEM	5 X - -	317
PIPLISHG	PRIOR ITEM PLISN	5 X L -	297
SAPLISHG	SAME AS PLISN	5 X L -	364
HARDCIHG	HARDNESS CRITICAL ITEM	1 A F -	151
REMIPIHG	REMAIN IN PLACE INDICATOR	1 A F -	348
LRUNITHG	LINE REPLACEABLE UNIT	1 A F -	194
ITMCATHG	ITEM CATEGORY CODE	2 X L -	177
ESSCODHG	ESSENTIALITY CODE	1 N F -	100
SMRCODHG	SOURCE, MAINTENANCE AND RECOVERABILITY CODE	6 X L -	389
MRRONEHG	MAINTENANCE REPLACEMENT RATE I	8 N R 4	211
MRRTWOHG	MAINTENANCE REPLACEMENT RATE II	8 N R 3	212
MRRMODHG	MAINTENANCE REPLACEMENT RATE MODIFIER	7 X F -	213
ORTDOOHG	ORGANIZATIONAL REPLACEMENT TASK DISTRIBUTION (RTD)	3 N R -	355
FRTDFFHG	INTERMEDIATE/DIRECT SUPPORT RTD	3 N R -	355
HRTDHHHG	INTERMEDIATE/GENERAL SUPPORT RTD	3 N R -	355
LRTDLLHG	SPECIAL REPAIR ACTIVITY RTD	3 N R -	355
DRTDDDHG	DEPOT/SHIPYARD RTD	3 N R -	355
MINREUHG	MINIMUM REPLACEMENT UNIT	3 N R -	245
MAOTIMHG	MAXIMUM ALLOWABLE OPERATING TIME	4 X - -	221
MAIACHTG	MAINTENANCE ACTION CODE	1 A F -	206
RISSBUHG	RECOMMENDED INITIAL SYSTEM STOCK BUY	3 N R -	328
RMSSLIHG	RECOMMENDED MINIMUM SYSTEM STOCK LEVEL	3 N R -	329
RTLLQTHG	RECOMMENDED TENDER LOAD LIST QUANTITY	3 N R -	331
TOTQTYHG	TOTAL QUANTITY RECOMMENDED	6 N R -	453
OMTDOOHG	ORGANIZATIONAL MAINTENANCE TASK DISTRIBUTION (MTD)	2 N R -	214
FMTDFFHG	INTERMEDIATE/DIRECT SUPPORT MTD	2 N R -	214
HMTDHHHG	INTERMEDIATE/GENERAL SUPPORT MTD	2 N R -	214
LMTDLLHG	SPECIAL REPAIR ACTIVITY MTD	2 N R -	214
DMTDDDHG	DEPOT/SHIPYARD MTD	2 N R -	214
CBDMTDHG	CONDEMNED BELOW DEPOT MTD	2 N R -	214
CADMTDHG	CONDEMNED AT DEPOT MTD	2 N R -	214

MIL-STD-1388-2B
APPENDIX A

ORCTOOHG	ORGANIZATIONAL REPAIR CYCLE TIME (RCT)	3 N R -	350
FRCTFFHG	INTERMEDIATE/DIRECT SUPPORT RCT	3 N R -	350
HRCTHHHG	INTERMEDIATE/GENERAL SUPPORT RCT	3 N R -	350
LRCTLLHG	SPECIAL REPAIR ACTIVITY RCT	3 N R -	350
DRCTDDHG	DEPOT/SHIPYARD RCT	3 N R -	350
CONRCTHG	CONTRACTOR RCT	3 N R -	350
NORETSHG	NOT REPAIRABLE THIS STATION	3 N R -	261
REPSURHG	REPAIR SURVIVAL RATE	3 N R -	351
DRPONEHG	DESIGNATED REWORK POINT ONE	6 X L -	081
DRPTWOHG	DESIGNATED REWORK POINT TWO	6 X L -	081
WRKUCDHG	WORK UNIT CODE	7 X L -	516
ALLOWCHG	ALLOWANCE ITEM CODE	2 X F -	017
ALIQTYHG	ALLOWANCE ITEM QUANTITY	3 N R -	018

120.8 Table HH, Overhaul-Kit Next Higher Assembly PLISN. This table contains all Next Higher Assembly (NHA), kit or overhaul PLISNs, any associated NHA PLISN Indicators, and Overhaul Replacement Rates. Table keys include: Reference Number (REFNUMHA); CAGE (CAGECDXH); EIAC (EIACODXA); LCN (LSACONXB); ALC (ALTLCNXB); LCN type (LCNTYPXB); and NHA PLISN (NHAPLIHH). NHA PLISN must be a PLISN contained in table XC (PLISNOXC) or table HG (PLISNOHG) with an identical PCCN (PCCNUMXC).

<u>CODE</u>	<u>DATA ELEMENT TITLE</u>	<u>FORMAT</u>	<u>DED</u>	<u>KEY</u>
CAGECDXH	CAGE CODE	5 X F -	046	F
REFNUMHA	REFERENCE NUMBER	32 X L -	337	F
EIACODXA	END ITEM ACRONYM CODE	10 X L -	096	F
LSACONXB	LSA CONTROL NUMBER (LCN)	18 X L -	199	F
ALTLCNXB	ALTERNATE LCN CODE	2 N F -	019	F
LCNTYPXB	LCN TYPE	1 A F -	203	F
NHAPLIHH	NEXT HIGHER ASSEMBLY (NHA) PROVISIONING LIST ITEM SEQUENCE NUMBER (PLISN)	5 X L -	258	K
NHAINDHH	NHA PLISN INDICATOR	1 X F -	259	
OVHREPHH	OVERHAUL REPLACEMENT RATE	3 N R 2	281	

120.9 Table HI, Provisioning Remark. This table contains text remarks associated with a part application for provisioning. Table keys include: Reference Number (REFNUMHA); CAGE (CAGECDXH); EIAC (EIACODXA); LCN (LSACONXB); ALC (ALTLCNXB); LCN Type (LCNTYPXB); and, Text Sequencing Code (TEXSEQHI).

<u>CODE</u>	<u>DATA ELEMENT TITLE</u>	<u>FORMAT</u>	<u>DED</u>	<u>KEY</u>
CAGECDXH	CAGE CODE	5 X F -	046	F
REFNUMHA	REFERENCE NUMBER	32 X L -	337	F
EIACODXA	END ITEM ACRONYM CODE	10 X L -	096	F
LSACONXB	LSA CONTROL NUMBER (LCN)	18 X L -	199	F
ALTLCNXB	ALTERNATE LCN CODE	2 N F -	019	F
LCNTYPXB	LCN TYPE	1 A F -	203	F
TEXSEQHI	PROVISIONING TEXT SEQUENCING CODE	5 N R -	450	K
REMARKHI	PROVISIONING REMARKS	65 X - -	311	

MIL-STD-1388-2B
APPENDIX A

120.10 Table HJ, Provisioning Reference Designation. This table contains Reference Designations associated with a part application for provisioning. Table keys include: Reference Number (REFNUMHA); CAGE (CAGECDXH); EIAC (EIACODXA); LCN (LSACONXB); ALC (ALTLCNXB); LCN Type (LCNTYPXB); and, Reference Designation (REFDESHJ). Nonidentifying keys, Technical Manual (TM) Code (TMCODEXI); Figure Number (FIGNUMHK); and Item Number (ITEMNOHK) migrate from table HK, if applicable, on matching foreign keys.

<u>CODE</u>	<u>DATA ELEMENT TITLE</u>	<u>FORMAT</u>	<u>DED</u>	<u>KEY</u>
CAGECDXH	CAGE CODE	5 X F -	046	F
REFNUMHA	REFERENCE NUMBER	32 X L -	337	F
EIACODXA	END ITEM ACRONYM CODE	10 X L -	096	F
LSACONXB	LSA CONTROL NUMBER (LCN)	18 X L -	199	F
ALTLCNXB	ALTERNATE LCN CODE	2 N F -	019	F
LCNTYPXB	LCN TYPE	1 A F -	203	F
REFDESHJ	REFERENCE DESIGNATION	64 X L -	335	K
RDCODEHJ	REFERENCE DESIGNATION CODE	1 A F -	336	
TMCODEXI	TECHNICAL MANUAL (TM) CODE	3 X F -	437	
FIGNUMHK	FIGURE NUMBER	4 X R -	144	
ITEMNOHK	ITEM NUMBER	4 X R -	184	

120.11 Table HK, Parts Manual Description. This table contains Repair Parts Manual data associated with a part application for provisioning. Table keys include: Reference Number (REFNUMHA); CAGE (CAGECDXH); EIAC (EIACODXA); LCN (LSACONXB); ALC (ALTLCNXB), LCN Type (LCNTYPXB); TM Code (TMCODEXI); Figure Number (FIGNUMHK); and Item Number (ITEMNOHK).

<u>CODE</u>	<u>DATA ELEMENT TITLE</u>	<u>FORMAT</u>	<u>DED</u>	<u>KEY</u>
CAGECDXH	CAGE CODE	5 X F -	046	F
REFNUMHA	REFERENCE NUMBER	32 X L -	337	F
EIACODXA	END ITEM ACRONYM CODE	10 X L -	096	F
LSACONXB	LSA CONTROL NUMBER (LCN)	18 X L -	199	F
ALTLCNXB	ALTERNATE LCN CODE	2 N F -	019	F
LCNTYPXB	LCN TYPE	1 A F -	203	F
TMCODEXI	TECHNICAL MANUAL (TM) CODE	3 X F -	437	F
FIGNUMHK	FIGURE NUMBER	4 X R -	144	K
ITEMNOHK	ITEM NUMBER	4 X R -	184	K
TMFGCDHK	TM FUNCTIONAL GROUP CODE (REPAIR PARTS MANUAL)	11 X L-	438	
TMINDCHK	TM INDENTURE CODE	1 N F -	439	
QTYFIGHK	QUANTITY PER FIGURE	3 N R -	318	
TMCHGNHK	TM CHANGE NUMBER	2 N R -	436	

120.12 Table HL, Parts Manual Provisioning Nomenclature. This table contains text for repair parts manual data associated with a part application for provisioning. Table keys include: Reference number (REFNUMHA); CAGE (CAGECDXH); EIAC (EIACODXA); LCN (LSACONXB); ALC (ALTLCNXB), LCN Type (LCNTYPXB); TM Code (TMCODEXI); Figure Number (FIGNUMHK); Item Number (ITEMNOHK); and, Text Text Sequencing Code (TEXSEQHL).

MIL-STD-1388-2B
APPENDIX A

<u>CODE</u>	<u>DATA ELEMENT TITLE</u>	<u>FORMAT</u>	<u>DED</u>	<u>KEY</u>
CAGECDXH	CAGE CODE	5 X F -	046	F
REFNUMHA	REFERENCE NUMBER	32 X L -	337	F
EIACODXA	END ITEM ACRONYM CODE	10 X L -	096	F
LSACONXB	LSA CONTROL NUMBER (LCN)	18 X L -	199	F
ALTLCNXB	ALTERNATE LCN CODE	2 N F -	019	F
LCNTYPXB	LCN TYPE	1 A F -	203	F
TMCODEXI	TECHNICAL MANUAL CODE	3 X F -	437	F
FIGNUMHK	FIGURE NUMBER	4 X R -	144	F
ITEMNOHK	ITEM NUMBER	4 X R -	184	F
TEXSEQHL	PARTS MANUAL TEXT SEQUENCING CODE	5 N R -	450	K
PROVNOHL	PROVISIONING NOMENCLATURE	65 X - -	310	

120.13 Table HM, Item Basis of Issue. This table contains part manual (tool list) Basis Of Issue (BOI) information. Table keys include: Reference Number (REFNUMHA); CAGE (CAGECDXH); and, BOI Control (BOICTRHM).

a. Either BOI-Level (LVLBOIHM) or BOI-End Item (RATIOBHM) must be entered to establish a row of information in this table. When one of these is entered, the other must be blank. Each LVLBOIHM and RATIOBHM value must be a unique value for a given Reference Number and CAGE combination.

b. A PLCC (DDPLCCHA) entry must be contained in table HA, and an entry in table HK for the item Reference Number and CAGE combination must occur prior to an entry in this table.

<u>CODE</u>	<u>DATA ELEMENT TITLE</u>	<u>FORMAT</u>	<u>DED</u>	<u>KEY</u>
CAGECDXH	CAGE CODE	5 X F -	046	F
REFNUMHA	REFERENCE NUMBER	32 X L -	337	F
BOICTRHM	BASIS OF ISSUE CONTROL	1 N F -	030	K
QTYBOIHM	BASIS OF ISSUE QUANTITY	5 N R -	030	M
RATIOBHM	BASIS OF ISSUE END ITEM	8 X L -	030	
LVLBOIHM	BASIS OF ISSUE LEVEL	1 A F -	030	

120.14 Table HN, Provisioning Serial Number Usable On Code. This table relates a part application to the applicable system/EI Serial Number (S/N) and S/N UOC associated with the part application. Please refer to table XD. Table keys include all columns. Table keys CAGECDHN, REFNUMHN, LSACONHN, and ALTLCNHN migrate from table HG. Table keys LCNSEIHN, ALCSEIHN, FRSNUMHN, and TOSNUMHN migrate from table XD. EIACODXA and LCNTYPXB are identical in both tables XD and HG.

<u>CODE</u>	<u>DATA ELEMENT TITLE</u>	<u>FORMAT</u>	<u>DED</u>	<u>KEY</u>
EIACODXA	END ITEM ACRONYM CODE	10 X L -	096	F
LCNTYPXB	LCN TYPE	1 A F -	203	F
CAGECDHN	S/N PROVISIONING CAGE CODE	5 X F -	046	F
REFNUMHN	S/N PROVISIONING REFERENCE NUMBER	32 X L -	337	F
LSACONHN	S/N PROVISIONING LSA CONTROL NUMBER (LCN)	18 X L -	199	F

MIL-STD-1388-2B
APPENDIX A

ALTLCNHN	S/N PROVISIONING ALTERNATE LCN CODE (ALC)	2 N F -	019	F
LCNSEIHN	S/N PROVISIONING SYSTEM/EI LCN	18 X L -	199	F
ALCSEIHN	S/N PROVISIONING SYSTEM/EI ALC	2 N F -	019	F
FRSNUMHN	S/N PROVISIONING SERIAL NUMBER FROM	10 X L -	373	F
TOSNUMHN	S/N PROVISIONING SERIAL NUMBER TO	10 X L -	373	F

120.15 Table HO, Provisioning System/End Item Usable On Code. This table relates a part application to the applicable System/End Item UOCs and Provisioning Contract Control Number (PCCN) associated with the part application. Table keys include all columns. Table keys CAGEDHO, REFNUMHO, LSACONHO, and ALTLCNHO migrate from table HG. Table keys LCNSEIHO and ALCSEIHO migrate from table XC, from which UOCs and the PCCN are extracted. EIACODXA and LCNTYPXB are identical in both tables XC and HG.

NOTE: Part application LCNs (LSACONHO) are mapped to their respective system/end items by matching on EIAC, LCN Type, LCN, and ALC between tables HO and XC to extract applicable UOCs and the PCCN. A part application can have multiple UOCs, but only one PCCN, with the exception of separately provisioned end items.

<u>CODE</u>	<u>DATA ELEMENT TITLE</u>	<u>FORMAT</u>	<u>DED</u>	<u>KEY</u>
EIACODXA	END ITEM ACRONYM CODE	10 X L -	096	F
LCNTYPXB	LCN TYPE	1 A F -	203	F
CAGECDHO	UOC PROVISIONING CAGE CODE	5 X F -	046	F
REFNUMHO	UOC PROVISIONING REFERENCE NUMBER	32 X L -	337	F
LSACONHO	UOC PROVISIONING LSA CONTROL NUMBER (LCN)	18 X L -	199	F
ALTLCNHO	UOC PROVISIONING ALTERNATE LCN CODE (ALC)	2 N F -	019	F
LCNSEIHO	UOC PROVISIONING SYSTEM/EI LCN	18 X L -	199	F
ALCSEIHO	UOC PROVISIONING SYSTEM/EI ALC	2 N F -	019	F

120.16 Table HP, Design Change Information. This table contains information about the parts application item affected by a design change. Table keys include: Reference Number (REFNUMHA); CAGE (CAGECDXH); EIAC (EIACODXA); LCN (LSACONXB); ALC (ALTLCNXB); LCN Type (LCNTYPXB); and, Change Authority Number (CANUMBHP).

a. Replaced or Superseding PLISN (RSPLISHP) must be established in either table HG or XC matching the PCCN of the HP table keys (less CANUMBHO). A Replaced or Superseded PLISN Indicator (RSPLINDHP) cannot be entered without a Replaced or Superseded PLISN (RSPLISHP).

b. Quantity Procured (QTYPROHP) must be entered if there is an entry in Quantity Shipped (QTYSHPHP). The QTYPROHP must be greater than or equal to the QTYSHPHP.

c. Prorated Exhibit Line Item (PROELIHP) must be entered if there is an entry in Prorated ELIN Quantity (PROQTYHP).

MIL-STD-1388-2B
APPENDIX A

<u>CODE</u>	<u>DATA ELEMENT TITLE</u>	<u>FORMAT</u>	<u>DED</u>	<u>KEY</u>
CAGECDXH	CAGE CODE	5 X F -	046	F
REFNUMHA	REFERENCE NUMBER	32 X L -	337	F
EIACODXA	END ITEM ACRONYM CODE	10 X L -	096	F
LSACONXB	LSA CONTROL NUMBER (LCN)	18 X L -	199	F
ALTLCNXB	ALTERNATE LCN CODE (ALC)	2 N F -	019	F
LCNTYPXB	LCN TYPE	1 A F -	203	F
CANUMBHP	CHANGE AUTHORITY NUMBER	15 X L -	043	K
RSPLISHP	REPLACED OR SUPERSEDING (R-S) PROVISIONING LIST ITEM SEQUENCE NUMBER (PLISN)	5 X L -	353	
RSPINDHP	R-S PLISN INDICATOR	1 A F -	354	
INTCHCHP	INTERCHANGEABILITY CODE	2 A F -	172	
TOTICHHP	TOTAL ITEM CHANGES	2 N R -	452	
QTYSHPHP	QUANTITY SHIPPED	6 N R -	323	
QTYPROHP	QUANTITY PROCURED	6 N R -	322	
PROELIHP	PRORATED EXHIBIT LINE ITEM NUMBER (ELIN)	6 X - -	305	
PROQTYHP	PRORATED QUANTITY	6 N R -	306	

120.17 Table HQ, Serial Number Effectivity. This table contains the serial number effectivity ranges which are affected by the design change. Table keys include all columns.

<u>CODE</u>	<u>DATA ELEMENT TITLE</u>	<u>FORMAT</u>	<u>DED</u>	<u>KEY</u>
CAGECDXH	CAGE CODE	5 X F -	046	F
REFNUMHA	REFERENCE NUMBER	32 X L -	337	F
EIACODXA	END ITEM ACRONYM CODE	10 X L -	096	F
LSACONXB	LSA CONTROL NUMBER (LCN)	18 X L -	199	F
ALTLCNXB	ALTERNATE LCN CODE	2 N F -	019	F
LCNTYPXB	LCN TYPE	1 A F -	203	F
CANUMBHP	CHANGE AUTHORITY NUMBER	15 X L -	043	F
FMSRNOHQ	FROM SERIAL NUMBER EFFECTIVITY	10 X L -	374	K
TOSRNOHQ	TO SERIAL NUMBER EFFECTIVITY	10 X L -	374	K

120.18 Table HR, Design Change Usable On Code. This table references to the UOC affected by a design change. Table keys include all columns. Design change UOC is extracted from table XC through table HO for the key of UOC system/EI (LCNSEIHO and ALCSEIHO) and UOC provisioning LCN/ALC (LSACONHO and ALTLCNHO). REFNUMHO, CAGECDHO, LSACONHO, and ALTLCNHO must be identical with REFNUMHA, CAGECDXH, LSACONXB, and ALTLCNXB from table HP migrating CANUMBHP into this table. EIACODXA and LCNTYPXB must be identical in Tables XC, HO, and HR.

<u>CODE</u>	<u>DATA ELEMENT TITLE</u>	<u>FORMAT</u>	<u>DED</u>	<u>KEY</u>
EIACODXA	END ITEM ACRONYM CODE	10 X L -	096	F
LCNTYPXB	LCN TYPE	1 A F -	203	F
CAGECDHO	UOC PROVISIONING CAGE CODE	5 X F -	046	F
REFNUMHO	UOC PROVISIONING REFERENCE NUMBER	32 X L -	337	F

MIL-STD-1388-2B
APPENDIX A

LSACONHO	UOC PROVISIONING LSA CONTROL NUMBER (LCN)	18 X L -	199	F
ALTLCNHO	UOC PROVISIONING ALTERNATE LCN CODE (ALC)	2 N F -	019	F
LCNSEIHO	UOC PROVISIONING SYSTEM/EI LCN	18 X L -	199	F
ALCSEIHO	UOC PROVISIONING SYSTEM/EI ALC	2 N F -	019	F
CANUMBHP	CHANGE AUTHORITY NUMBER	15 X L -	043	F

MIL-STD-1388-2B
APPENDIX A

130. TRANSPORTABILITY ENGINEERING ANALYSIS. Data tables beginning with "J" in the first position of the table code are structured to capture the information pertaining to the transportability shipping modes and to the transported end item. In the event that the end item is sectionalized for transport, the information shall be completed for each section of the end item. Figure 13 depicts the relational hierarchy of these tables/entities.

<u>TABLE CODE</u>	<u>TABLE TITLE</u>
JA	Transportation
JB	Transportation Shipping Mode
JC	Transported End Item
JD	Transported End Item Narrative
JE	Transport by Fiscal Year
JF	Transportation Narrative

130.1 Table JA, Transportation. This table identifies the transportation characteristics of the system/equipment under analysis. It describes what is required for the system/equipment to be transported. The table keys consist of EIAC (EIACODXA), LCN (LSACONXB), ALC (ALTLCNXB), LCN Type (LCNTYPXB). For a given row of information, the following cross-element edits apply to table JA:

- a. The transportability area can only be used if an item has been identified by a Sectionalized Item Transportation Indicator (SECITMXB) table XB, or by a Transportation End Item Indicator (TRASEIXC) table XC.
- b. If the system/equipment is being sectionalized for transportation, then a Sectionalized Identification (SECTIDJA) should be filled out.
- c. If the system/equipment has environmental considerations, a (y) should be entered in the Environmental Handling and Transportation Indicator (ENHATCJA).

<u>CODE</u>	<u>DATA ELEMENT TITLE</u>	<u>FORMAT</u>	<u>DED</u>	<u>KEY</u>
EIACODXA	END ITEM ACRONYM CODE	10 X L -	096	F
LSACONXB	LSA CONTROL NUMBER (LCN)	18 X L -	199	F
ALTLCNXB	ALTERNATE LCN CODE	2 N F -	019	F
LCNTYPXB	LCN TYPE	1 A F -	203	F
TRNINDJA	TRANSPORTATION INDICATOR	1 A F -	468	
SECTIDJA	SECTIONALIZED IDENTIFICATION	2 N R -	366	
ENHATCJA	ENVIRONMENTAL HANDLING AND TRANSPORTATION INDICATOR	1 A F -	098	
DELSCHJA	DELIVERY SCHEDULE	1 A F -	075	
CONNUMJA	TRANSPORTATION CONTRACT NUMBER	19 X L -	055	
PROPSNJA	PROPER SHIPPING NAME	60 X - -	304	
SPSPEDJA	SPEED	3 N R -	400	
TWSPEDJA	TOWING SPEED	3 N R -	455	
MILUNTJA	MILITARY UNIT TYPE	240 X - -	242	

MIL-STD-1388-2B
APPENDIX A

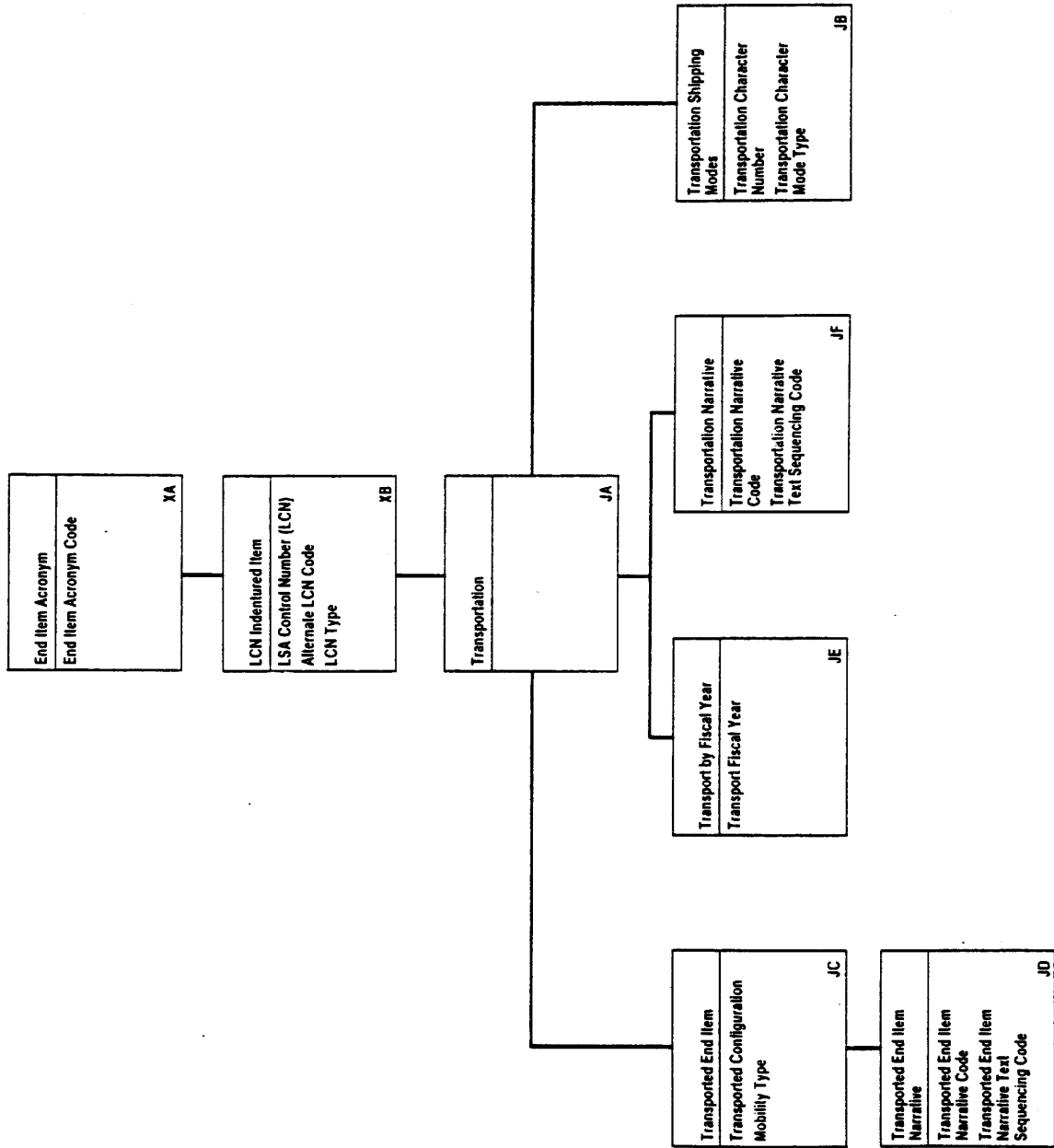

MIL-STD-1388-2B
APPENDIX A

TRCHRDJA	REVISION DATE	6 N F -	071
TRCHTHJA	THEATER OF OPERATION	5 A L -	451
NOPRFFJA	NONOPERATIONAL FRAGILITY FACTOR	2 N R -	260
NETEXWJA	NET EXPLOSIVE WEIGHT	10 N R -	254

130.2 Table JB, Transportation Shipping Modes. This table identifies the different possible transportation shipping modes for the system/equipment under analysis. This table can identify the different types of aircraft and whether the aircraft will transport the item under analysis externally or internally. This table can identify the different type of helicopters, their mission capabilities, and whether the helicopter will transport the item under analysis externally or internally. This table can identify the highway prime and alternate model types and what type of payload capacity the transporter has. This table can identify the type of lighterages and whether the item under analysis can be stowed on deck. This table can identify the type of rail system that will be used and which countries the rail system will run through for the item under analysis. This table can identify the type of ships and whether the item under analysis can be stowed on deck. The table keys consist of EIAC (EIACODXA), LCN (LSACONXB), ALC (ALTLCNXB), LCN Type (LCNTYPXB), Transportation Characteristic Number (TRANCNJB), and Transportation Mode Type (TRCHMTJB). For a given row of information, the following cross-element edits apply to table JB:

a. This table can only be used if an (S or B) has been entered in the Transportation Indicator (TRNINDJA) table JA.

b. Transportation Item Designator (TRITDRJB) and External or Internal Load Indicator (EOILINJB) should only be used when the Transportation Character Mode Type of (A) for an aircraft is entered.

c. External or Internal Load Indicator (EOILINJB) and Transportation Item Designator (TRITDRJB) for an aircraft must either both be blank, or have entries.

d. Transportation Item Designator (TRITDRJB), Helicopter Mission Altitude (HMATLRJB), Helicopter Mission Distance (HMDISRJB), Helicopter Mission Payload (HMPAYRJB), Helicopter Mission Temperature (HMTMPRJJB), Helicopter Mission Time (HMTIMRJB), and External or Internal Load Indicator (EOILINJB) should only be filled out when the Transportation Character Mode Type (TRCHMTJB) of (B) for a helicopter is entered.

e. External or Internal Load Indicator (EOILINJB) and Transportation Item Designator (TRITDRJB) for a helicopter must either both be blank, or have entries.

f. Highway Prime Load (HIPRMLJB), Highway Prime Model Type (HIPRMTJB), Highway Alternate Load (HALTMLJB), and Highway Alternate Model Type (HALTMTJB) should only be filled out when the Transportation Character Mode Type (TRCHMTJB) of (C) is entered.

g. Highway Prime Model Load (HIPRMLJB) and Highway Prime Model Type (HIPRMTJB) must either both be blank, or have entries.

MIL-STD-1388-2B
APPENDIX A

h. Highway Alternate Model Load (HALTMLJB) and Highway Alternate Model Type (HALTMTJB) must either both be blank, or have entries.

i. Sea Deck Stowage (SDECKSJB) and Transportation Item Designator (TRITDRJB) and should only be filled out when the Transportation Character Mode Type (TRCHMTJB) of (D) for a lighterage is entered.

j. Sea Deck Stowage (SDECKSJB) and Transportation Item Designator (TRITDRJB) must either both be blank, or have entries.

k. Transportation Item Designator (TRITDRJB), Rail Use (RAILUSJB) and Rail Transportation Country (RAILTCJB) should only be filled out when the Transportation Character Mode Type (TRCHMTJB) of (E) is entered.

l. Rail Use (RAILUSJB) and Rail Transportation Country (RAILTCJB) must either both be blank, or have entries.

m. Sea Deck Stowage (SDECKSJB) and Transportation Item Designator (TRITDRJB) should only be filled out when the Transportation Character Mode Type (TRCHMTJB) of (F) for a ship is entered.

n. Sea Deck Stowage (SDECKSJB) and Transportation Item Designator (TRITDRJB) must either both be blank, or have entries.

o. Container Length (CONLENJB) and Container Type (CONTYPJB) must either both be blank, or have entries.

<u>CODE</u>	<u>DATA ELEMENT TITLE</u>	<u>FORMAT</u>	<u>DED</u>	<u>KEY</u>
EIACODXA	END ITEM ACRONYM CODE	10 X L -	096	F
LSACONXB	LSA CONTROL NUMBER (LCN)	18 X L -	199	F
ALTLCNXB	ALTERNATE LCN CODE	2 N F -	019	F
LCNTYPXB	LCN TYPE	1 A F -	203	F
TRANCNJB	TRANSPORTATION CHARACTER NUMBER	2 N R -	465	K
TRCHMTJB	TRANSPORTATION CHARACTER MODE TYPE	1 A F -	464	K
TRITDRJB	TRANSPORTATION ITEM DESIGNATOR	26 X L -	469	
SHPCONJB	SHIPPING CONFIGURATION	2 A L -	380	
CONLENJB	CONTAINER LENGTH	2 N R -	053	
CONTYPJB	CONTAINER TYPE	36 X L -	054	
FRCLASJB	FREIGHT CLASSIFICATION	7 X L -	146	
EOILINJB	EXTERNAL OR INTERNAL LOAD INDICATOR	1 A F -	104	
HMATLRJB	HELICOPTER MISSION ALTITUDE	5 N R -	159	
HMDISRJB	HELICOPTER MISSION DISTANCE	3 N R -	159	
HMPAYRJB	HELICOPTER MISSION PAYLOAD	5 N R -	159	
HMTMPRJB	HELICOPTER MISSION TEMPERATURE	3 N R -	159	
HMTIMRJB	HELICOPTER MISSION TIME	3 N R 1	159	
HIPRMLJB	HIGHWAY PRIME MODEL LOAD	1 A F -	250	
HIPRMTJB	HIGHWAY PRIME MODEL TYPE	19 X L -	251	
HALTMLJB	HIGHWAY ALTERNATE MODEL LOAD	1 A F -	250	
HALTMTJB	HIGHWAY ALTERNATE MODEL TYPE	19 X L -	251	
RAILUSJB	RAIL USE	5 A L -	326	
RAILTCJB	RAIL TRANSPORTATION COUNTRY	240 X - -	325	
SDECKSJB	SEA DECK STOWAGE	1 A F -	072	

MIL-STD-1388-2B
APPENDIX A

130.3 Table JC, Transported End Item. This table provides information pertaining to a System/EI that is to be transported. The table keys consist of EIAC (EIACODXA), LCN (LSACONXB), ALC (ALTLCNXB), LCN Type (LCNTYPXB), Transported Configuration Number (TRANCNJC), and Mobility Type (MOBTYPJC). For a given row of information, the following cross-element edits apply to table JC:

a. This table can only be used if an (E or B) has been entered in the Transportation Indicator (TRNINDJA) table JA.

b. Operational Weight Empty (OPWEEMJC) and Military Load Classification Empty (HICLNEJC) must either both be blank, or have entries.

c. Operational Weight Loaded (OPWELDJC) and Military Load Classification Loaded (HICLNLJC) must either both be blank, or have entries.

d. Skid Number of Skids (SNUMSKJC), Skid Area (SDSICGJC), and Skid Area UM (SKADUMJC) should only be used when the Mobility Type (MOBTYPJC) of (A) is entered.

e. Skid Area (SDSICGJC) and Skid Area UM (SKADUMJC) must either both be blank, or have entries.

f. Tracked Ground Pressure (TRGRPRJC), Tracked Road Wheel Weight (TRRWWTJC), Tracked Pads Touching (TRNUPTJC), Tracked Pad Shoe Area (TRPSARJC), and Tracked Pad Shoe Area UM (TPSAUMJC) should only be used when the Mobility Type (MOBTYPJC) of (B) is entered. Wheeled Inflation Pressure (WHINPRJC), Wheeled Number of Tires (WHNUTIJC), Wheeled Tire Load Ratings (WHTLDRJC), Wheeled Tire Size (WHTIFTJC), and Wheeled Weight Ratings (WHWERAJC) may also apply to tracked vehicles.

g. Tracked Pad Shoe Area (TRPSARJC) and Tracked Pad Shoe Area UM (TPSAUMJC) must either both be blank, or have entries.

h. Wheeled Inflation Pressure (WHINPRJC), Wheeled Number of Tires (WHNUTIJC), Wheeled Tire Load Ratings (WHTLDRJC), Wheeled Tire Size (WHTIFTJC), and Wheeled Weight Ratings (WHWERAJC) should be used when the Mobility Type (MOBTYPJC) of (C) is entered.

<u>CODE</u>	<u>DATA ELEMENT TITLE</u>	<u>FORMAT</u>	<u>DED</u>	<u>KEY</u>
EIACODXA	END ITEM ACRONYM CODE	10 X L -	096	F
LSACONXB	LSA CONTROL NUMBER (LCN)	18 X L -	199	F
ALTLCNXB	ALTERNATE LCN CODE	2 N F -	019	F
LCNTYPXB	LCN TYPE	1 A F -	203	F
TRCONMJC	TRANSPORTED CONFIGURATION NUMBER	2 N R -	473	K
MOBTYPJC	MOBILITY TYPE	1 A F -	249	K
OPWEEMJC	OPERATIONAL WEIGHT EMPTY	4 N R 1	276	
HICLNEJC	MILITARY LOAD CLASSIFICATION EMPTY	2 N R -	241	
OPWELDJC	OPERATIONAL WEIGHT LOADED	4 N R 1	276	
HICLNLJC	MILITARY LOAD CLASSIFICATION LOADED	2 N R -	241	
SHWEEMJC	SHIPPING WEIGHT EMPTY	4 N R 1	381	
SHWELDJC	SHIPPING WEIGHT LOADED	4 N R 1	381	

MIL-STD-1388-2B
APPENDIX A

CREANGJC	CREST ANGLE	2 N R -	063
TRGRPRJC	TRACKED GROUND PRESSURE	7 N R -	456
TRRWWTJC	TRACKED ROAD WHEEL WEIGHT	6 N R 1	459
TRNUPTJC	TRACKED PADS TOUCHING	2 N R -	458
TRPSARJC	TRACKED PAD SHOE AREA	6 N R 1	457
TPSAUMJC	TRACKED PAD SHOE AREA	2 A F -	491
	UNIT OF MEASURE		
WHINPRJC	WHEELED INFLATION PRESSURE	3 N R -	507
WHNUPLJC	WHEELED NUMBER OF PLYS	2 N R -	508
WHNUTIJC	WHEELED NUMBER TIRES	2 N R -	509
WHTLDRJC	WHEELED TIRE LOAD RATINGS	10 X L -	510
WHTIFTJC	WHEELED TIRE SIZE	10 X L -	512
WHWERAJC	WHEELED WEIGHT RATINGS	10 X L -	513
TWALFIJC	LENGTH FRONT INSIDE	4 N R 1	029
TWALFOJC	LENGTH FRONT OUTSIDE	4 N R 1	029
TWALRIJC	LENGTH REAR INSIDE	4 N R 1	029
TWALROJC	LENGTH REAR OUTSIDE	4 N R 1	029
SNUMSKJC	SKID NUMBER OF SKIDS	2 N R -	264
SDSICGJC	SKID AREA	6 N R 1	384
SKADUMJC	SKID AREA UNIT OF MEASURE	2 A F -	491

130.4 Table JD, Transported End Item Narrative. This table may be used to identify Tire Requirements, Skid Remarks, Tracked Wheeled Remarks, Turning Information, Axle and Suspension Remarks, and Other Transported Equipment. The table keys consist of EIAC (EIACODXA), LCN (LSACONXB), ALC (ALTLCNXB), LCN Type (LCNTYPXB), Transported Configuration Number (TRANCNJC), and Mobility Type (MOBTYPJC), Transported End Item Narrative Code (TREINCJD), and Transported End Item Narrative Text Sequencing Code (TEXSEQJD). For a given row of information, the following cross-element edits apply to table JD:

- a. If the Transported End Item Narrative Code (TREINCJD) is (A), then this table identifies any pertinent information pertaining to the tires for the system under analysis (Wheeled Tire Requirements, DED 511).
- b. If the Transported End Item Narrative Code (TREINCJD) is (B), then this table describes any pertinent information pertaining to skid areas for the system under analysis (Skid Remarks DED, 385).
- c. If the Transported End Item Narrative Code (TREINCJD) is (C), then this table describes the tracked/ wheeled turning diameter which will include wall-to-wall, curb-to-curb (Turning Information, DED 477).
- d. If the Transported End Item Narrative Code (TREINCJD) is (D), then this table describes any information pertaining to the axle and suspension system of the item under analysis (Wheeled Axle and Suspension Remarks, DED 506).
- e. If the Transported End Item Narrative Code (TREINCJD) is (E), then this table captures all other information pertaining to a item that is being transported which is not tracked, wheeled, or skid mounted (Transported Other Equipment, DED 475).

<u>CODE</u>	<u>DATA ELEMENT TITLE</u>	<u>FORMAT</u>	<u>DED</u>	<u>KEY</u>
EIACODXA	END ITEM ACRONYM CODE	10 X L -	096	F

MIL-STD-1388-2B
APPENDIX A

LSACONXB	LSA CONTROL NUMBER (LCN)	18 X L -	199	F
ALTLCNXB	ALTERNATE LCN CODE	2 N F -	019	F
LCNTYPXB	LCN TYPE	1 A F -	203	F
TRCONMJC	TRANSPORTED CONFIGURATION NUMBER	2 N R -	473	F
MOBTYPJC	MOBILITY TYPE	1 A F -	249	F
TREINCJD	TRANSPORTED END ITEM NARRATIVE CODE	1 A F -	474	K
TEXSEQJD	TRANSPORTED END ITEM NARRATIVE TEXT SEQUENCING CODE	5 N R -	450	K
WHTRLOJD	TRANSPORTED END ITEM NARRATIVE	65 X - -	---	

130.5 Table JE, Transport by Fiscal Year. This table contains information about the system/equipment procurement and delivery schedule. The table keys consist of EIAC (EIACODXA), LCN (LSACONXB), ALC (ALTLCNXB), LCN Type (LCNTYPXB), and Transport Fiscal Year (TRAFYRJE).

<u>CODE</u>	<u>DATA ELEMENT TITLE</u>	<u>FORMAT</u>	<u>DED</u>	<u>KEY</u>
EIACODXA	END ITEM ACRONYM CODE	10 X L -	096	F
LSACONXB	LSA CONTROL NUMBER (LCN)	18 X L -	199	F
ALTLCNXB	ALTERNATE LCN CODE	2 N F -	019	F
LCNTYPXB	LCN TYPE	1 A F -	203	F
TRAFYRJE	TRANSPORT FISCAL YEAR	2 N F -	145	K
FIQPQTJE	FIRST QUARTER PROCUREMENT QUANTITY	3 N R -	298	
SQPQTYJE	SECOND QUARTER PROCUREMENT QUANTITY	3 N R -	298	
TQPQTYJE	THIRD QUARTER PROCUREMENT QUANTITY	3 N R -	298	
FQPQTYJE	FOURTH QUARTER PROCUREMENT QUANTITY	3 N R -	298	

130.6 Table JF, Transportation Narrative. This table may be used to identify Transportation Shock and Vibration Requirements, Lifting and Tiedown Remarks, Projection Characteristics, Regulatory Requirements, Special Services and Equipment, Sectionalized Remarks, Transportation Remarks, Transport To/From Remarks, Environmental Considerations, Military Distance Classification, Unusual and Special Requirements, Venting and Protective Clothing, and Disaster Response Force. The table keys consist of EIAC (EIACODXA), LCN (LSACONXB), ALC (ALTLCNXB), LCN Type (LCNTYPXB), Transportation Narrative Code (TRANCDJF), and Transportation Narrative Text Sequencing Code (TRANARJF). For a given row of information, the following cross-element edits apply to table JF:

a. If the Transportation Narrative Code (TRANCDJF) is (A), then this table should state the fragility, shock, and vibration considerations required for the system/equipment under analysis (Transportation Shock Vibration Remarks, DED 382).

b. If the Transportation Narrative Code (TRANCDJF) is (B), then this table identifies the number, location, and strength of the lifting provisions and tiedown remarks for the system/equipment under analysis (Lifting and Tiedown Remarks, DED 192).

MIL-STD-1388-2B
APPENDIX A

c. If the Transportation Narrative Code (TRANCDJF) is (C), then this table states the dimensions and locations of any significant projections of the system under analysis (Transportation Projection Remarks, DED 471).

d. If the Transportation Narrative Code (TRANCDJF) is (D), then this table describes data to show compliance with regulatory requirements (Regulatory Requirements, DED 340).

e. If the Transportation Narrative Code (TRANCDJF) is (E), then this table provides a narrative field for transportation remark which may include towing, self-propelled, handling, and air dropped information, plus any transportation information not captured in other data elements or other narrative fields. (Transportation Remarks, DED 472).

f. If the Transportation Narrative Code (TRANCDJF) is (F), then this table describes any information concerning the requirements for special services and equipment (railcars, highway vehicles, or materiel handling equipment) when required for the system under analysis (Special Service and Equipment, DED 398).

g. If the Transportation Narrative Code (TRANCDJF) is (G), then this table provides the sectionalization information for each section that is being transported (Sectionalized Remarks, DED 368).

h. If the Transportation Narrative Code (TRANCDJF) is (H), then this table describes from where the item is transported and to where the item is transported (Transported To and From, DED 476).

i. If the Transportation Narrative Code (TRANCDJF) is (I), then this table provides information concerning any special environmental/hazardous considerations required for the transportation of the system/equipment under analysis (Environmental/Hazardous Materials Considerations, DED 099). For this table to be used, a (Y) must be entered into the Environmental Handling and Transportation Indicator (ENHATCJA) table JA.

j. If the Transportation Narrative Code (TRANCDJF) is (J), then this table describes the military quantity distance class and storage compatibility groups (Military Distance Classification, DED 240). For this table to be used, a (Y) must be entered into the Environmental Handling and Transportation Indicator (ENHATCJA) table JA.

k. If the Transportation Narrative Code (TRANCDJF) is (K), then this table describes any unusual item transportation characteristics (e.g. temperature limits, humidity limits, escorts required, etc.) (Unusual and Special Requirements, DED 500). For this table to be used, a (Y) must be entered into the Environmental Handling and Transportation Indicator (ENHATCJA) table JA.

l. If the Transportation Narrative Code (TRANCDJF) is (L), then this table describes the venting and protective clothing requirements (Venting and Protective Clothing, DED 504). For this table to be used, a (Y) must be entered into the Environmental Handling and Transportation Indicator (ENHATCJA) table JA.

m. If the Transportation Narrative Code (TRANCDJF) is (M), then this

MIL-STD-1388-2B
APPENDIX A

table describes in detail all disaster response force requirements for a transportation disaster encountered while transporting the item (Disaster Response Force Requirements, DED 082). For this table to be used, a (Y) must be entered into the Environmental Handling and Transportation Indicator (ENHATCJA) table JA.

<u>CODE</u>	<u>DATA ELEMENT TITLE</u>	<u>FORMAT</u>	<u>DED</u>	<u>KEY</u>
EIACODXA	END ITEM ACRONYM CODE	10 X L -	096	F
LSACONXB	LSA CONTROL NUMBER (LCN)	18 X L -	199	F
ALTLCNXB	ALTERNATE LCN CODE	2 N F -	019	F
LCNTYPXB	LCN TYPE	1 A F -	203	F
TRANCDJF	TRANSPORTATION NARRATIVE CODE	1 A F -	470	K
TEXSEQJF	TRANSPORTATION NARRATIVE TEXT	5 N R -	450	K
	SEQUENCING CODE			
TRANARJF	TRANSPORTATION NARRATIVE	65 X - -	---	

THIS PAGE LEFT INTENTIONALLY BLANK

APPENDIX B

LOGISTIC SUPPORT ANALYSIS RECORD REPORTS

10. PURPOSE. This appendix contains a listing and description of the Logistic Support Analysis (LSA) Record (LSAR) reports and guidance for data utilization. Reports will be selected by the requiring authority to tailor and document the results of the support analysis tasks based on criteria as stated in Appendix D. This documentation provides the capability of developing product summaries from a common data source, thus, enhancing data uniformity and reducing data product cost. These reports may be automatically produced from a validated LSAR automated data processing ADP system. Requirements of this appendix will be referenced and implemented in contractual documents, as specified in the Contract Data Requirements List (CDRL).

20. CONCEPT. An LSAR ADP system will, as a minimum, produce the reports shown on figures 15 through 60 on an individual basis from computer stored data. This capability permits automatic generation of product and analysis reports capable of satisfying the cited data item descriptions in paragraph 6 of this standard. A validated LSAR ADP system can be used to automatically generate the summaries contained in this appendix based upon the specific ADP processing requirements of the validated system. When required, any or all of the LSAR reports contained in this appendix can be manually produced. When the LSAR reports are manually prepared, they shall be in accordance with (IAW) the content, format, sequence and computational requirements contained in paragraph 30 and figure 14.

20.1 LSAR data table to report matrix. Figure 14 contains a matrix of LSAR data tables to reports. Finding a report across the top of figure 14, and then reading down the column, a user can determine the specific data elements required to produce the given report. The data appearing on the summaries; required to qualify an item for a summary; used in report calculations; modified when used on an output; and, keys of the tables directly impacting a report generation, are all specified by an identifying code. The data table "business rules" and edits may dictate that additional data tables must be established prior to making a specific table entry, e.g., establishing a foreign key.

20.2 General report selection criteria. Unless otherwise specified in the report description, LSA summaries described in this appendix shall be in ASCII sequence. The following basic rules are provided as guidance for report selection:

a. For Service Designator Code (DED 368) selections, choosing A, F, N, or M results in the selection of the matched service designator code and X and J codes. Choosing T results in selection of both T and J codes. All other code selections results in extraction of matched code data only. Service designator qualification in many instances will occur by task code (DED 419).

b. Lower-tiered or "trailer" LSA Control Number (LCN) and Alternate LCN Code (ALC) selections may be made against any report which specifies selection by LCN/ALC range. This further defining a report selection is used when multiple configurations, alternate design or maintenance concepts, or

alternate vendors are contained in the LSAR. For example, as a rule, the basic configuration of an equipment is identified by LCNs with no ALC entry. Where alternate(s) at the component level are documented and the alternate is required on the specified report, the basic selection would have no ALC entry. However, a lower indentured LCN may also be used with the report selection to obtain the specific LCN(s) and ALC(s) of the assembly(s) to be substituted for the basic configuration. Lower indentured LCN selections will include the subordinate items to the alternate selected. Once the alternate assembly(s) and their breakdown have been selected, the selection process will revert back to the original LCN selection.

c. The Usable On Code (UOC) (DED 501) is a primary (and often mandatory) selection criteria when selecting LSAR reports by LCN. It is used to identify the model/configuration relationship of each LCN comprising a system/equipment and to control these relationships for LSAR report generation. The UOC is critical, and should therefore be used when establishing an LSAR. This requirement holds even if only one configuration/model of a system/equipment is being documented. In accordance with table XC, contained in appendix A of this standard, each configuration/model is assigned a unique UOC at the system/end item level LCN. Each individual assembly/component/piece part is also "linked" to the assigned UOC of the model of which it is applicable through tables XF and HO. When an assembly/component/piece part is applicable to more than one configuration/model, then multiple UOCs are "linked" to the component for a single LCN and ALC via tables XF and HO. This eliminates the requirement of duplicating analysis and related data, merely because an item has application to multiple configurations/models. For further information on the UOC, LCN, and ALC relationship, refer to appendix C.

30. LSAR REPORTS.

30.1 LSA-001, Man-Hours by Skill Specialty Code and Level of Maintenance. A report divided into two parts. It is used to determine manpower requirements of the system/equipment, and to determine the time required and number of personnel, by Skill Specialty Code (SSC), and person identifier to perform each task. The format is contained on figure 15. Spacing between rows and columns is not critical on this report.

30.1.1 Part I contains a summary of annual man-hour expenditures by maintenance levels and SSC. Man-hour totals are based on the number of systems supported by level of maintenance. The number of maintenance tasks used to develop the report are displayed. The man-hour values displayed in each column (level of maintenance) are derived for each SSC by multiplying the task frequency, times the sum of the man-minutes per person identifier, divided by 60 and summing those values for each maintenance task performed by a particular SSC. At the option of the user, more than one end item, system, component, etc., supported, at any given maintenance level, may be requested. Then the annual maintenance man-hours displayed on the output report will be for the number of end items, systems, components, etc., specified. These values are obtained by multiplying the number of items supported by each maintenance level times the annual maintenance man-hours involved. Part I is sequenced by ascending SSC.

30.1.2 Part II contains a report of the man-hours, by person identifier, expended on each maintenance task. Man-hours are the sum of the man-minutes per person identifier for the same person identifier involved in a task,

divided by 60. An evaluation of the skill specialty and the requirement for training equipment is provided for each task code. It provides annual man-hours per item per maintenance task, and total man-hours per maintenance task based on number of systems supported, and can be obtained for a specific SSC/ Skill Evaluation Code. The annual man-hours per item column is obtained by multiplying the task frequency times the man-minutes involved for the maintenance task for a specific person identifier. The total annual man-hours column is derived by multiplying the number of systems supported, as specified by the user, times the annual man-hours per item column. Part II is sequenced by ascending SSC, then LCN, and finally task code.

30.2 LSA-003, Maintenance Summary. A report which compares the current status of the system maintenance parameters with the requirements recorded on the A data tables. The format is contained on figure 16. Spacing between rows and columns is not critical on this report.

30.2.1 Task code functions of "O", "T", "U", "V", "Y", and "3 - 9", and task code interval of "Y" are not used in the LSA-003 report calculations. The elapsed time and man-hour values printed on the status line of the report are calculated from data on the C data tables in the following manner:

$$ETm = \frac{\sum_{i=1}^N (ETi) (TFi)}{N}$$

$$M-Hm = \frac{\sum_{i=1}^N (M-Hi) (TFi)}{N}$$

ETm = Mean elapsed time
M-Hm = Mean man-hours
ETi = Elapsed time for task i (DED 224)
TFi = Task frequency for task i (DED 430)
M-Hi = Total man-hours for task i (DED 225)
N = Total number of tasks performed

The preceding computations are performed for each of the following groupings of tasks at crew and organizational operation/maintenance (O/M) Levels:

- a. Daily Inspection (task code position 1 is "A", and position 2 is "C").
- b. Preoperative Inspection (task code position 1 is "A", and position 2 is "A").
- c. Post Operative Inspection (task code position 1 is "A", and position 2 is "H").
- d. Periodic Inspection (task code position 1 is "A", and position 2 is "E" or "B").
- e. Mission Profile Change (task code position 1 is "M").
- f. Turnaround (task code position 5 is "F").

Also, the preceding computations are performed for unscheduled tasks (task code position 2 is F, G, or J) at all maintenance levels.

MIL-STD-1388-2B
APPENDIX B

30.2.2 The scheduled and unscheduled values for annual man-hours per end item are derived utilizing data from the C tables for a given LCN using the task interval codes F, G, and J for unscheduled tasks and all remaining task interval codes scheduled. The following calculations are performed at each maintenance level:

$$(M-Hs)_a = \sum_{i=1}^N (TF_i) (M-Hs)_i \qquad (M-Hu)_a = \sum_{i=1}^N (TF_i) (M-Hu)_i$$

(M-Hs)_a = Annual man-hours for scheduled maintenance
(M-Hu)_a = Annual man-hours for unscheduled maintenance
TF_i = Task frequency for task i (DED 430)
(M-Hs)_i = Total man-hours for scheduled maintenance
task i (DED 225)
(M-Hu)_i = Total man-hours for unscheduled maintenance
task i (DED 225)
N = Total number of tasks performed

The scheduled and unscheduled values are summed to yield total annual man-hours per end item.

30.2.3 The scheduled and unscheduled man-hours per operating hour are calculated by dividing the annual man-hours per end item from the LSA-003 Report by the annual operating requirements specified on the A table. This calculation is performed at each O/M level.

30.2.4 The status totals for all levels are calculated by summing the man-hours for each level of maintenance.

30.2.5 The organizational inspection section is always shown first. The remainder of the report is sequenced by ascending maintenance level (crew to depot).

30.3 LSA-004, Maintenance Allocation Chart Summary. The maintenance allocation chart (MAC) Summary is a report consisting of four sections, three of which are obtainable from the LSAR. Section I, Introduction, is "boiler plate" information developed IAW either figures 20 or 21 of MIL-M-63038 (TM) Manuals, Technical (Army). Sections II, MAC; III, Tool and Test Equipment Requirements; and IV, Remarks are produced as separate sections of this summary. The report is provided in standard or aviation format IAW figures 20, and 21, respectively, of MIL-M-63038 (TM) (Army). A report may be printed on plain bond paper. It is used as source information for the final MAC contained in the organizational maintenance TM. Formats for the proof standard, and aviation, and draft MAC are contained on figure 17. Spacing between rows and columns is not critical on the draft MAC.

30.3.1 Section II, consists of the man-hour allocations by maintenance function and maintenance level. Task functions (1st position task code) for the draft MAC will appear as they do in the LSAR database. Task functions not allowed on a proof MAC will be automatically included as follows:

- a. Access, Disassemble/Assemble, and Fault Locate times are included as

part of the repair time.

- b. End-of-Runway Inspection times are included as part of inspect time.
- c. Remove and Install times are included as part of the Remove/Install time.
- d. Remove and Replace times are included as Replace time.
- e. Lubricate times are included as part of the service times.
- f. Task Function Codes of "Q", "M", "U", "V", "O", "Y", "T", and "2 - 9" are not included on the MAC. The Task Interval Code "Y" is also not included on the MAC.

30.3.2 Operations/Maintenance (O/M) Level "G" is not included on the proof MAC. The O/M level "L" is included as part of Maintenance Category "H" on the standard MAC. Only O/M levels of "O", "F", and "D" apply when the aviation MAC is developed. Maintenance category aviation unit (AVUM) equates to "O"; aviation intermediate (AVIM) to "F"; and Depot to "D".

30.3.3 For each O/M Level, the mean-man hours is calculated for all tasks with the same task function as follows:

$$M-Hm = \frac{\sum_{i=1}^N (TFi) (M-Hi)}{\sum_{i=1}^N TFi}$$

- M-Hm = Mean man-hours
- M-Hi = Man-hours for task i (DED 225)
- TFi = Task frequency for task i (DED 430)
- N = Total number of tasks performed

Man-hours are rounded to the nearest tenth of an hour. Section II is sequenced by ascending LCN or Functional Group Code (FGC) (depending on the display option selected), then by ascending maintenance function based on the first position of the task code.

30.3.4 Section III, Tool and Test Equipment Requirements. This section of the MAC consists of tools and test equipment required by task function and maintenance level. The section may be selected by item category code (ICC) or combination of ICCs. The section is used to identify tools and test equipment required to perform the maintenance functions listed on the Section II Maintenance Allocation Summary. Sections II and III are cross-indexed by the "Tool or Test Equipment Reference Code." Section III is sequenced by ascending reference numbers.

30.3.5 Section IV, Remarks. The Remarks section is based upon Remarks entered against qualified MAC tasks. Sections II and IV are cross indexed by the Remarks Code contained in column 6 of section II and the Reference Code of

section IV. Only the proof MAC and Aviation MAC contain section IV. Section IV is sequenced by ascending remarks reference code.

30.4 LSA-005, Support Item Utilization Summary. A report, by ICC, showing the use of the item by maintenance level and LCN. The report should be used to justify the requirement for support equipment and determine the quantity and distribution requirements. The report should also be used to determine recommended order quantities of repair parts based on their total use. The format is contained on figure 18. Spacing between rows and columns is not critical on this report.

30.4.1 The user has the option to choose between elapsed time an item of support equipment is used, or the quantity of support items utilized. If the elapsed time option is selected, only the following ICCs are allowed: D, E, F, G, H, J, M, N, P, R, S, T, U, V, AC, and 1 through 8. If the quantity option is selected, only the following ICCs are utilized in the report: K, L, Q, W, X, Y, Z, AA, AB, AD, AE, and 9.

30.4.2 At each O/M Level, the total elapsed time for all tasks, where a particular item of support equipment is used, is calculated as follows:

$$ETt = \sum_{i=1}^N (TFi) (ETi)$$

ETt = Total elapsed time
TFi = Task frequency for task i (DED 430)
ETi = Elapsed time for task i (DED 224)
N = Total number of tasks performed

30.4.3 At each O/M Level, the total quantity of a repair part is calculated for each task where the repair part is used as follows:

$$TQ = \sum_{i=1}^N (TFi) (QTY/TASK) i$$

TQ = Total quantity
TFi = Task frequency for task i (DED 430)
(QTY/TASK) i = Quantity per task i (DED 319)
N = Total number of tasks performed

30.4.4 The total elapsed time usage for support equipment for all maintenance levels, or total quantity for repair part for all maintenance levels, is calculated by summing the total elapsed time usage or quantity, respectively, for each level of maintenance.

30.4.5 When man-hours or elapsed times are reported, each value will be preceded by (P) or (M) to indicate predicted or measured values being reported. Where a measured value has not been input, the report will default

to the predicted value.

30.4.6 The report is sequenced by ascending ICC first, then by ascending reference number, by maintenance level, and by LCN or FGC (depending on which is selected in the display option).

30.5 LSA-006, Critical Maintenance Task Summary. The report provides a list of all maintenance tasks which exceed a specific value for task frequency, or elapsed time, or man-hours, or annual man-hours. The specific value(s) exceeded is identified as critical criteria. The report may be selected for any maintenance level or combination of levels and for scheduled or unscheduled maintenance. The report should be used to pinpoint problem areas and plan maintenance for critical components. The format is contained on figure 19. Spacing between rows and columns is not critical on this report.

30.5.1 If unscheduled maintenance is selected, then task codes must contain an F, G, or J in the second position. If scheduled maintenance is selected, task codes must contain an A, B, C, E, H, K, L, M, N, P, Q, or R in the second position. Task interval codes (second position) of "Y", battlefield damage assessment and repair, (BDAR) are not included in any LSA-006 calculations.

30.5.2 Annual man-hours are calculated by multiplying the mean man-hours by the task frequency for a given task.

30.5.3 When man-hours or elapsed times are reported, each value will be preceded by (P) or (M) to indicate predicted or measured values being reported. Where a measured value has not been input, the report will default to the predicted value.

30.5.4 The report is sequenced by descending critical value. If the critical values are identical, the report sequences by ascending LCN, then by ascending task codes (starting with the first position).

30.6 LSA-007, Support Equipment Requirements. A report of all support equipment (i.e., tools, test equipment, etc.) utilized by SSC and level of maintenance. The report may be selected for any maintenance level or combination of levels. This report should be used to develop tool kits for each skill specialty at each level of maintenance. The format is contained on figure 20. Spacing between rows and columns is not critical on this report.

30.6.1 ICCs are limited to D, G, H, M, N, P, R, V, AC, and 1 through 8. This report is sequenced first according to the selected sequence option (SEQ OPT) (SSC then O/M Level, or vice-versa), then by LCN or FGC (depending on the selected display option), and then by ascending reference number.

30.7 LSA-008, Support Items Validation Summary. This summary provides a listing of those support items required to support/perform the task at each maintenance level. The support items are categorized in groups of:

Support/Test Equipment and Tools (ICC D, G, H, M, N, P, R, V, 1-8, AC)
Spare and Repair Parts (ICC X, Y, Z, 9, AA, AB, AE)
Other (ICC, E, F, J, Q, S, T, W, AD)

30.7.1 This summary will be used to review support items requirements for the maintenance and operator task(s) involved and may be selected for an entire

equipment, specific LCN range, maintenance level, or ICC(s). The ICC grouping sequence is Support/Test Equipment and Tools first, Spare and Repair Parts, then Other. Within each category, the report is sequenced by ascending maintenance level (crew to depot), then by ascending reference number. The format is contained on figure 21. Spacing between rows and columns is not critical on this report.

30.8 LSA-009, Support Items List. A report by LCN, reference number, and national stock number (NSN), of all repair parts, tools/test equipment necessary to support the system/equipment. The report may be selected for any ICC or combination of ICCs, or single or multiple provisioning technical documentation selection code. It is sequenced in either ascending LCN or reference number/commercial and government entity (CAGE) code. The provisioning unit of measure price only, appears on the LSA-009 summary. The report should be used to provide information necessary to assist in performing provisioning. The format is contained on figure 22. Spacing between rows and columns is not critical on this report.

30.9 LSA-010, Parts Standardization Summary. A report by reference number of all spare and repair parts comprising the system/equipment. The report may be selected for any contractor technical information code (CTIC) or CTIC combination and for any acquisition method code (AMC) or AMC combination. It can be utilized to assist in performance of DOD Replenishment Parts Breakout Program. The report is sequenced by ascending reference numbers. The format is contained on figure 23. Spacing between rows and columns is not critical on this report.

30.10 LSA-011, Special Training Equipment/Device Summary. A report of all operator or maintenance tasks, which have been identified as requiring a special training device and the narrative explanation of the training equipment requirement. The report should be used to identify the requirements, and provide justification, for the acquisition of training devices. The format is contained on figure 24. Spacing between rows and columns is not critical on this report.

30.10.1 As a minimum, at least one LCN within the selected range must have a qualified task that has a valid entry for mean man-minutes and for mean minute elapsed time. Also, the qualified LCN must contain a "Y" code entry for Training Equipment Requirement Code. This report is sequenced by ascending LCN or FGC (depending on the display option chosen), then by ascending task codes (starting with the first position).

30.11 LSA-012, Facility Requirement. A report of all tasks which have been identified as requiring new or modified facilities, or facility requirements identified for training. Tasks reported are limited to those documented against specific LCN range and service designator code. In addition, a "Y" must be entered in the CA table, Requirements For, to qualify for inclusion into the list. Also included in this summary are narrative explanation and justifications of facility requirements. At the option of the requiring authority, existing facilities may also be documented and reported. The report should be used to provide requirement and justification for the construction of new facilities, or to determine additional work load at existing facilities. The format is contained on figure 25. Spacing between rows and columns is not critical on this report.

MIL-STD-1388-2B
APPENDIX B

30.11.1 When man-hours or elapsed times are reported, each value will be preceded by (P) or (M) to indicate predicted or measured values. Where a measured value has not been input to the LSAR, the report will default to the predicted value. Overflows of Reference Number exceeding 16 positions are printed on the next line immediately below the first position of the Reference Number.

30.11.2 The LSA-012 report is sequenced by ascending values of LCN, or with an option to sequence by a selected facility category code and all higher values. The report is selective by RPT TYP which will delineate between a test, operational, training, or depot facility.

30.12 LSA-013, Support Equipment Grouping Number Utilization Summary. A report by maintenance level and Support Equipment Grouping Identification Number of the tasks, which use the support equipment group. The report may be selected for any maintenance level or combination of levels. The report should be used to provide the requirements, quantity, and justification for the acquisition of support equipment. The format is contained on figure 26. Spacing between rows and columns is not critical on this report.

30.12.1 When man-hours or elapsed times are reported, each value will be preceded by (P) or (M) to indicate predicted or measured values being reported. Where a measured value has not been input, the report will default to the predicted value.

30.13 LSA-014, Training Task List. A report by SSC of each task identified in the task inventory. As an option, it will display only those tasks for which training is recommended. If this option is selected, then the report will output the rationale for training recommendations and training location requirements necessary to perform a given task. The report should be used to recommend a task for training and provide the basis for recommendation of the training location of the task. The format is contained on figure 27. Spacing between rows and columns is not critical on this report.

30.13.1 If the Training Recommended option is selected, then LCNs must qualify by checking for a Training Recommendation Code of B, C, or J. This report is sequenced by ascending SSC, then by ascending LCN.

30.14 LSA-016, Preliminary Maintenance Allocation Chart (PMAC). A preliminary report of task allocation by maintenance function and maintenance level, and a preliminary report of tools, equipment, and spares/repair parts required by task function and maintenance level. The report is used to identify tools and equipment by maintenance levels to perform the maintenance functions, and to validate Source, Maintenance, and Recoverability (SMR) Codes for spares and repair parts. It is divided into three parts. Part I is the basic maintenance allocations and is sequenced in either ascending LCN or TM FGC; part II contains the tool listing; and part III contains the spare/repair part listing. Both parts II and III are sequenced in ascending Reference Number and CAGE. The format is contained on figure 28. Spacing between rows and columns is not critical on this report.

30.14.1 ICCs for parts II and III, Tools and Parts for the PMAC, may only be chosen from the following ICC values for each grouping:

Tools (ICC - D, G, H, M, N, P, R, V, 1-8, AC, AD)

Parts (ICC - X, Y, Z, 9, AA, AB, AE)

30.14.2 Task codes with task functions of Q, Z, P, M, O, U, V, C, Y, T, and 2 through 9, and task interval of Y are excluded from the PMAC. The task function is spelled out on the report and the O/M level code is displayed, following the function, in parenthesis.

30.14.3 The man-hours (M-HRS) are calculated for all tasks with the same task function as follows:

$$M-Hm = \frac{\sum_{i=1}^N (TF_i) (M-H_i)}{\sum_{i=1}^N TF_i}$$

M-Hm = Mean man-hours

M-Hi = Man-hours for task i (DED 225)

TFi = Task frequency for task i (DED 430)

N = Total number of tasks performed

30.14.4 If any or all of the mean man-hours for the LSA-016 summary are predicted, the man-hour column will be followed by a (P). If all man-hours are measured, an (M) will appear.

30.14.5 The "NUMBER" appearing on part I is assigned based on the sequence of the LCN or FGC. The tool and part references are assigned based on the sequence of the tool/part in parts II and III, respectively.

30.15 LSA-018, Task Inventory Summary. This summary is a comprehensive listing of all tasks performed by system personnel to operate and maintain the item. It can be used in workload analysis to model crew member activities and to create operating and some maintenance scenarios. The report is capable of producing an inventory of tasks for all "Jobs" (Table CJ) within a given system, or for selected "Job" combinations. The format is contained on figure 29. Spacing between rows and columns is not critical on this report.

30.15.1 The report will be sequenced by ascending Job Code (Table CJ) and ascending Duty Codes (Table CJ) within each Job. Duty will be printed out left justified on the output and Job will appear in parentheses following Duty. Task Identification will be indented beneath Duty and Job; Subtask Identification will be indented beneath Task Identification; and the Element narrative will be indented beneath Subtask Identification (if applicable).

30.16 LSA-019, Task Analysis Summary. This summary provides a listing of support items and skill specialty requirements needed to perform maintenance tasks. The report is designed to be used in the preparation of maintenance manuals and during physical teardown logistic demonstration (PTLD), both to record data as a result of the PTLD, and to review the results of the PTLD against the LSAR database. At the option of the user, the report may also contain the narrative sequential subtask description for each task, and the description of those subtasks which are referenced. The referenced subtask descriptions will appear in the proper sequence of the task description requested. The summary may be requested by maintenance level, Hardness

Critical Procedure (HCP), task interval, task function, and SSCs/ICC(s). The format is contained on figure 30. Spacing between rows and columns is not critical on this report.

30.16.1 The support items identified in the LSAR database to perform the identified task are categorized by ICC in the same manner as described for the LSA-008 summary.

30.16.2 If the HCP option is selected, then only tasks with an associated HCP code of Y or S will qualify and be output. If the task interval (second position of task code) option or task function (first position of task code) option is chosen, only tasks with the selected task interval and/or task function will qualify.

30.16.3 If the task narrative option is selected, tasks should have a valid mean man-minute entry and mean minute elapsed time entry and a support item suppression option can be selected. If the task narrative option is not selected, then either predicted or measured elapsed times and man-hours are allowable with measured taken first precedence and the support items cannot be suppressed.

30.16.4 There is a space available at the end of each LCN for the reviewer to manually insert and describe those support items not identified in the LSAR, but found to be required during the PTLD review. Also, there is space available for manual entries for manually measured elapsed time, manually measured man-hours, actual quantity used, manual evaluation, and reviewer's name.

30.16.5 This report is sequenced by ascending LCN or FGC (depending on display option selected), then by ascending task code. The support items portion is sequenced by ascending ICC (A-Z, 1-9), then by ascending reference number.

30.17 LSA-023, Maintenance Plan Summary. The report consists of four parts which may be selected together or individually. Part I contains general information pertaining to the system/item selected and the maintenance concept and plan rationale. Part II contains the reliability, availability, and maintenance characteristics of the system/item. This part may be selected by LCN or work unit code for the desired maintenance level. Part III describes the preventive and corrective maintenance action requirements. Corrective tasks are determined by task interval code values of "J", "F", and "G". Part IV contains a listing of required support equipment and associated technical data by ICC. This part may be selected for any ICC or combination of ICCs. The report can be sequenced by either LCN or TM-FGC. Format contained on Figure 31. Spacing between rows and columns is not critical on this report.

30.17.1 The LSA-023 summary is selective by mandatory EIAC, Start LCN, ALC, Type, UOC, and Serv Des; and optional Stop LCN. Part 3 is selected by either preventive, corrective, or both type tasks. Part 4 selection also requires specifying the ICCs for support equipment requirements of each task. The ICCs allowable for part 4 are: D, G, H, M, N P, R, V, 1-8, and AC (see appendix E, DED 177, for a listing and definitions of various ICCs).

30.17.2 In part 1, reference number, CAGE, and item designator code may not appear if LCN Type is functional (F). In Part 2, NSN and related data,

reference number, CAGE, Maximum Allowable Operating Time (MAOT), Maintenance Action Code (MAC), SMR, Unit of Issue (UI), and UI Price may not appear if LCN Type is functional. In part 3, the number (NO) SSC can be calculated by summing up the number of person identifiers in table CD for a given SSC for a given task. When man-hours or elapsed times are reported, each value will be preceded by (P) or (M) to indicate predicted or measured values being reported. Where a measured value has not been input to the LSAR, the report will default to the predicted value. Overflows of Reference Number exceeding 16 positions are printed on the next line immediately below the first position of the Reference Number.

30.17.3 Depending upon the display option chosen, for parts 1, 2, and 4 when the display option of TM FGC is selected, the output is sorted by ascending TM FGC, then ascending LCN. If LCN option is selected, those sections are sequenced by LCN first, then TM FGC. Part 3, A and B sections, should be sequenced by maintenance level (crew to depot), ascending LCN, then ascending task code (starting with the first position).

30.18 LSA-024, Maintenance Plan. The report consists of three parts which may be selected together or individually. Part I contains general considerations (design description, maintenance plan summary, and maintenance plan rationale) for the LCN selected. Part II describes the repair capability required to support the LCN selected and includes maintenance technical data for the LCN selected and its lower indenture level repairable items, and maintenance significant consumable items. Part III contains a list of the maintenance tasks by category (preventive, corrective, servicing and calibration) for the LCN selected and its lower assembly repairable items. The report can be selected for any maintenance level by LCN down to piece part. The format is contained on figure 32. Spacing between rows and columns is not critical on this report.

30.18.1 The following definitions are for header information for the LSA-024 summary which are not contained in the LSAR:

a. Date of Initial Submission/Revision/Date of Revision. A 19-position field containing the date of the initial submission of the maintenance plan, alphabetic revision indicator, and date of the current revision. The dates and revision should be entered in the following format, including slashes and dashes: MM-DD-YY/A/MM-DD-YY.

b. Preparing Activity. A 15-position field containing the name of the performing activity having responsibility for the data.

c. Prepared By. A 15-position field containing the name of the individual having responsibility for accuracy of the data.

d. Defense Logistics Services Center (DLSC) Screen Date. An eight position field containing the date indicating when screening results were accepted by the government on all repairable items. The date should be entered in the following format, including dashes: MM-DD-YY.

e. Navy Ammunition Logistic Code (NALC). A four position alphanumeric code identifying the generic description within the Federal Supply Class. The NALC is assigned by Ships Parts Control Center (SPCC). The NALC is used for fleet reporting/requisitioning of ammunition and to indicate functional

interchangeability of items.

f. Maintenance Plan Number. A number identifying each maintenance plan. The maintenance plan number is assigned by the requiring authority (DED 209).

30.18.2 Definitions for technical factors are as follows:

a. Maintenance Replacement Factor (MRF) Repairables. The expected rate at which an item is found to be beyond the capability of maintenance (BCM) below the depot level and is inducted at the depot for repair or condemnation per maintenance cycle.

b. MRF Consumables. The predicted number of times an item will require replacement (due to failure, forced removal) in one maintenance cycle at the Organizational/Intermediate levels of maintenance.

c. Depot Scrap Rate (DSR). The expected percentage of the items scrapped at the depot level per maintenance cycle.

d. Below DSR (BDSR). The predicted number of times in one maintenance cycle that a field level repairable will be disposed of at the Organizational/Intermediate levels of maintenance.

e. Rotatable Pool Factor (RPF). The predicted number of times in one maintenance cycle that an item is removed from its next higher assembly at the Organizational/Intermediate level of maintenance, repaired at the Intermediate level and returned to ready for issue at this level.

f. System Attrition Rate (SAR). The percentage of depot level repairable items that fail, which will not, through repair, be returned to a serviceable condition.

g. Repair Survival Rate (RSR). The percent of nonserviceable repairable assets which will, through depot repair, be returned to serviceable condition.

h. Rework Removal Rate (RRR). The percentage of the total quantity of a repairable assembly installed in an end item which will require some depth of rework concurrently with that end item.

i. Interval. The recommended operating hours, or usage rate, followed by an alpha character indicating the type of maintenance requirements for an item. The calculation and codes are as follows:

$$\text{Interval} = \frac{\text{Annual Operating Requirement (AOR) (Conversion Factor)}}{\text{Task Frequency}}$$

- P. Preventive (task functions A and Z)
- C. Corrective (task functions B, G, R, J, H, L, K, N, S, O, W, and 2)
- T. Servicing (task functions P, M, and C)
- U. Calibration (task functions D, E, and F)

j. Maintenance Cycle. This data is calculated as follows:

$$\text{Maintenance Cycle} = \text{AOR} \times \text{Conversion Factor}$$

30.18.3 The calculations for technical factors are computed as follows:

$$\text{MRF} = [\text{MTD(D)} + \text{MTD(CAD)}] \times \text{MRR}$$

(Repairables)

$$\text{Numeric Stockage Objective (NSO)} = \text{RMSS LVL (DED 329)}$$

$$\text{DSR} = \frac{\text{MTD(CAD)}}{\text{MTD(D)} + \text{MTD(CAD)}}$$

$$\text{BDSR} = \text{MTD(CBD)} \times \text{MRR}$$

$$\text{RPF} = [\text{MTD(F)} + \text{MTD(H)}] \times \text{MRR}$$

$$\text{SAR} = 1 - \frac{\text{MTD(D)}}{\text{MTD(D)} + \text{MTD(CAD)} + \text{MTD(CBD)}}$$

$$\text{RSR} = \frac{\text{MTD(D)}}{\text{MTD(D)} + \text{MTD(CAD)}} \quad (\text{DED 351})$$

$$\text{RRR} = \text{Overhaul Replacement Rate (DED 281)}$$

where;

MTD = Maintenance task distribution

MTD(F) = Second subfield of the MTD

MTD(H) = Third subfield of the MTD

MTD(D) = Fifth subfield of the MTD

MTD(CBD) = Sixth subfield of the MTD

MTD(CAD) = Seventh subfield of the MTD

MRR = Maintenance Replacement Rate

30.18.4 Part II interchangeability/replaceability (I/R) code is determined based on the interchangeability code (IC) entered in table HP:

<u>IC</u>	<u>I/R</u>
OW	I
OR	I
TW	I
OM	R
TM	R
NI	Blank
NR	Blank

When multiple ICs are contained in table HP for a given reference number, CAGE, LCN and ALC combination, the order of precedence for I/R assignments are "I" followed by "R", then blank.

30.18.5 Part III, Requirement Number (REQ NO) is a five position counter (first four positions are numeric and the last position is alphabetic), which is generated based on the type of task being displayed. The counter begins at 0001 for each type of task and the alpha codes consist of P (preventive), C (corrective), T (servicing), and U (calibration).

30.18.6 Part I is sequenced by ascending LCN or FGC (depending on display

option selected); Part II is ascending LCN, then ascending reference number; and, Part III is sequenced by ascending LCN, then maintenance type (in the order of P, C, T, and U).

30.19 LSA-025, Packaging Requirements Data. A report of the basic data requirements for preservation and packing for common, selective, and special group items. This report consists of four 80-character card record formats of packaging information as specified by MIL-STD-2073. The report should be used to provide adequate packaging instructions for DOD users. It is selectable by either LCN range, a specified reference number and CAGE combination, or by a specified degree of protection (DOP). An optional 80-card column magnetic tape output is also available. The report is sequenced in ascending reference number and CAGE, and DOP. The format is contained on figure 33.

30.19.1 The Supplemental Card Indicator (SCI) is generated on the LSA-025 summary based on the following:

- If only an "A" card is used, the SCI is "1".
- If an "A" and "B" card are used, the SCI is "2".
- If an "A", "B", and "C" card are used, the SCI is "3".
- If an "A", "B", and "D" card are used, the SCI is "4".

30.20 LSA-026, Packaging Developmental Data. A report of the basic item identification data required for packing and preservation. The report can be requested by a single or multiple LCN, specific reference number or UOC, or SMR source code. The report can be used as a stand-alone or in conjunction with LSA-025 to provide packaging information for DOD users. It is sequenced in ascending reference number and CAGE; within each reference number. The UI prices are listed in descending order; application information is sorted in ascending LCN sequence. The format is contained on figure 34. Spacing between rows and columns is not critical on this report.

30.21 LSA-027, Failure/Maintenance Rate Summary. A report identifying an item and annual operating requirements by LCN and task code. Only tasks with a task function of "H" or "J" are included in this report. The report should be used to provide information necessary to monitor failure rates, failure modes, task frequencies, and MRRs. The format is contained on figure 35. Spacing between rows and columns is not critical on this report.

30.21.1 The user has the option of selecting this report based on the Operating Program, Operating Measurement Base, and the MRRI/MRRII Ratio. When option 1 of the MRRI/MRRII ratio is selected, the user should enter the required operating program and it's associated measurement base (MB). The operating MB should correspond to the MB of the AOR of the item under analysis. If the MRRII is to be calculated, enter the required MRRI/MRRII ratio. If left blank, then MRRII cannot be calculated.

30.21.2 The report provides both the table value and the calculated value of task frequency and MRRs I and II. The task frequency is calculated as described in DED 430, appendix E. The MRRI is calculated using the following formula:

$$\text{MRRI} = \text{Task Frequency} \times \text{Qty/Task} \times \frac{\text{Operating Program (selected)}}{\text{AOR}}$$

The MRRII is calculated using the following formula:

$$\text{MRRII} = \text{MRRI} \times \text{MRRI/MRRII ratio (selected)}.$$

30.21.3 When failure rate, mean time between maintenance (MTBM)-induced, and MTBM-no defect are reported, each value is preceded by (M), (P), (A), or (C) to indicate measured, predicted, allocated, and comparative analysis values, respectively. Where a measured value has not been entered, the report will default to the predicted, then allocated, and finally comparative analysis.

30.21.4 The report is sequenced by ascending values of LCN for a given task code, then ascending task codes. This holds true for the assembly LCN, repair part LCN, and task LCN. For the reliability, availability, and maintainability (RAM) LCNs, they are sequenced in ascending value, then by failure mode indicators (FMI).

30.22 LSA-030, Indentured Parts List. This report consists of four options:

- a. Option 1 - Draft Repair Parts and Special Tools List (RPSTL)
- b. Option 2 - Proof RPSTL
- c. Option 3 - Illustrated Parts Breakdown (IPB)
- d. Option 4 - Stockage List Type Four

The format for each option is contained on figure 36.

30.22.1 The draft/proof RPSTL consists of four sections prepared IAW MIL-STD-335(TM) or MIL-M-49502(TM) (Reference MIL-M-49502(TM), paragraph 6.4, for applicable document):

- a. Section I, Introduction
- b. Section II, Repair Parts List
- c. Section III, Special Tools List
- d. Section IV, Cross-Reference Indexes

Sections II, III and IV listings are produced as separate sections of this report. The lists may be printed on plain bond paper or may be output to a word processor file to be used as source information for final RPSTL preparation. The format contained on figure 34 represents MIL-STD-335(TM). Reference MIL-M-49502(TM) for the correct format if that document is to be used in lieu of MIL-STD-335(TM).

30.22.2 Documentation of kits for RPSTL. In order to produce kit/kit component listings for the RPSTL, a kit record first must be established and a Provisioning List Item Sequence Number (PLISN) assigned to this item. In the data table, Overhaul-Kit NHA PLISN, against the application of the kit component record, an NHA PLISN entry of the Kit PLISN with an NHA PLISN Indicator of "*" is required. Where the kit component appears in the RPSTL hardware breakout, the phrase "PART OF KIT P/N" (automatically generated), followed by the reference number of the kit, will be displayed following the

provisioning nomenclature in the description column. The kit components are automatically generated beneath the kit. The component listing contains the applicable figure number, item number and quantity per assembly/figure duplicated from the hardware breakout information.

30.22.3 FGC Header. A maximum of 9 lines of 36-position FGC or illustration header information may be entered for each RPSTL figure listing. These headers are not stored in the LSAR.

30.22.4 The report is selectable by technical manual (TM) code and number and TM FGC range. Sections II and III are sequenced by ascending TM FGC, then item number, and PLISN. Section IV, Part Number Index, is sorted in ascending reference number and CAGE; Stock Number Index in ascending NSN national item identification number, Reference Designation Index in ascending reference designation; and, Figure and Item Number Index in ascending figure and item number.

30.22.5 Specific RPSTL processing (draft and proof).

a. The FGC headers are placed in the description column preceding the first row of data matching on FGC with the FGC header key.

b. The PART NUMBER column contains 16-positions of the reference number. If the reference number exceeds 16 positions, the remainder is printed immediately beneath the first 16 on the next line.

c. For the description column, the item name will first appear, then two spaces followed by the provisioning nomenclature, if applicable. The provisioning nomenclature is wrapped in the 36-positions allocated for the description with "breaks" occurring only at spaces. Trailing periods are placed following the last position of the item name/provisioning nomenclature to the end of the description column. If there is an associated TM indenture code, then leading periods are placed prior to the item name, equal to the number in the TM indenture code field.

d. If there is a nuclear hardness critical item code of "Y" against the item, the symbol "(HCI)" will appear following the item name and preceding the provisioning nomenclature.

e. Following the provisioning nomenclature on a separate line, applicable UOCs of the item are entered, preceded by "UOC: ". For the proof RPSTL, if the item has full effectivity, no UOCs are displayed. Full effectivity is determined by comparison of the item's associated UOCs with all the associated UOCs to the PCCN of the item. For the draft RPSTL, applicable UOCs are always shown regardless of full effectivity.

f. Also extracted for kit entries are information of kit NHAs, which are handled as described in paragraph 30.22.2. The Kit Reference Number is determined by a match of the Kit NHA PLISN to a PLISN under the same PCCN in the parts application provisioning data table. One item may be used in multiple "kits" by multiple kit NHA PLISN HH entries. Beneath each kit, the rows that make up the kit are displayed using by item name, and in parenthesis the quantity per assembly or quantity per figure, the figure number, a dash, then the item number.

MIL-STD-1388-2B
APPENDIX B

g. Under the QTY column, the quantity per figure is displayed, unless blank. If quantity per figure is blank, then quantity per assembly is used.

h. Under the NSN column, a "Y" is displayed if both the federal supply classification (FSC) and National Item Identification Number (NIIN) are not blank and the NIIN does not contain alpha characters for the associated item. Otherwise "N" is displayed.

i. Under the Provisioning List Category Code (PLCC) column, only entries in Tools and Test Equipment PLCC or "D"s are shown.

j. After all information following a FGC header is displayed, and before the next FGC header the phrase "END OF FIGURE" is printed. The information is printed with no line skips between rows. At the end of a page, a page number is assigned using the figure number from the first record following the FGC header, followed by dash then "1". Multiple pages of the same figure follow the same pattern, e.g., 3-1, 3-2, 3-3, etc. A page break occurs with each new FGC Header set under a different FGC. If no FGC header is provided, the report "page breaks" each time the figure number changes.

k. The section III description column is similar to the section II description with the addition of the interpreted basis of issue (BOI). Each BOI is displayed by "BOI: " quantity, then either level or end item. The level is interpreted (see DED 030). The end item is preceded by "PER" and followed by "END ITEMS". The BOI is inserted between the provisioning nomenclature and the UOC lines.

l. Section IV cross-reference indexes are produced as optional outputs, as specified by the requester. The reference designations for the reference designation index will either include those items having a nonidentifying migrating key of the appropriate figure and item number, if these keys are present, or will include all related figure and item numbers, if these keys are not in the reference designation table. Overflows of reference numbers or reference designations exceeding 16 or 32 positions, respectively, are printed on the next line immediately below the first portion of the element.

30.22.6 The IPB consists of four sections prepared IAW MIL-M-38807(USAF):

- a. Section I, Front Matter
- b. Section II, Maintenance Parts List
- c. Section III, Numerical Index
- d. Section IV, Reference Designation Index

Sections II, III and IV (each section is optional) listings are produced as separate sections of this report. The lists may be printed on plain bond paper or may be output to a word processor file to be used as source information for final IPB preparation.

30.22.7 Documentation of kits for IPB. Extracted for the IPB are any entries in table HH for qualified rows matching on PLISNs which have an NHA PLISN with an NHA PLISN indicator of asterisk (*). Where the row of information is sorted in the report, the phrase "PART OF KIT P/N" will be displayed followed

MIL-STD-1388-2B
APPENDIX B

by the Reference Number of the Kit. The Kit Reference Number is determined by a match of the table HH NHA PLISN to a table HG PLISN under the same PCCN as the kit component. One row of data may be used for a kit with multiple table HH row entries (kit components). Beneath each kit, the components that make up the kit are displayed by item name, and in parentheses the Quantity per Figure (QTYFIGHK) or Quantity per Assembly (QTYASYHG), Figure Number (FIGNUMHK), a dash, then Item Number (ITEMNOHK).

30.22.8 The IPB report is selectable by technical manual/technical order (TM) code and number. Section II is sequenced by ascending figure number, then index number and Section III by ascending Reference Number. Section IV, Reference Designation Index, is sorted in ascending reference designation.

30.22.9 Stockage List Type Four. This option provides a listing of support items required for a system/equipment. The listing is used as source information for preparation of stockage list type four parts manuals.

30.22.10 The following data headers appearing on the LSA-030 are modified DED, or are in addition to the data element dictionary definitions.

a. Reference Designation (Figure Key) (REF DESIG FIG-KEY). Reference Designation with an associated Reference Designation Code of "F" (first eight positions only).

b. Special Stockage Indicator (SSI). Assigned by the requiring authority, the SSI is left blank by the preparing activity.

c. Replacement Factor (REPL FACTOR). MRRI, fourth through seventh positions only.

d. Quantity per Application and Equipment. These entries are the Quantity per Assembly and Quantity per End Item, respectively.

e. Item No. Item Number is a numeric entry assigned to each item in the report beginning with "1".

30.22.11 The report is selected by LCN range and is sequenced in ascending Reference Designation.

30.23 LSA-032, Defense Logistics Information System (DLIS) Submittals. This summary provides a cross-reference between reference numbers selected for provisioning screening and the submitter's control number. DLIS screening is specified by MIL-STD-1388-1A. This summary provides a valuable tool once the items have been screened through DLSC files, and the screening results are received as the DLIS results are sequenced by submitter's control number. The format is contained on figure 37.

30.23.1 The following definitions are related to terms located on the LSA-032 summary, but not contained in the LSAR:

a. Document Identifier Code (DIC). A three-position alphanumeric code which is used for identifying interservice agency or intraservice agency logistic transactions. Reference number and CAGE screening requests are identified by DIC "LSR". Items may be excluded from DLIS screening, if an

MIL-STD-1388-2B
APPENDIX B

entry showing a screening result, is already contained in the DIC field for the reference number and CAGE.

b. Priority Indicator Code (PIC). A single numeric code used to designate the required priority to be applied to processing transactions (see DOD 4100.38-M).

c. Activity Code. A two-position alpha code identifying a DOD activity, Federal agency or other authorized government agency for cataloging, standardization or other management purposes (see DOD 4100.38-M).

d. Destination Code. A five-position alphanumeric code used in conjunction with the activity code to register the address data for recipients of the results of provisioning screening (see DOD 4100.38-M).

e. Output Data Request Code (ODRC). A numeric series of established sets of data (Defense Integrated Data System output segments) identified by specific ODRCs and available for extraction from DLSC files for provisioning and preprocurement screening purposes (see DOD 4100.38-M).

f. Single/Multiple Output Code. A numeric code used by the submitter to indicate whether the results of screening are to be furnished to one or all of the recipients as registered under the applicable activity code and destination code (see DOD 4100.38-M).

g. Submitter's Control Number. A 17-position computer assigned alphanumeric field peculiar to provisioning and preprocurement screening transactions which is used to control and reference the transactions. The number consists of a four position julian date (YDDD), and a unique sequential 13 position number assigned for each reference number and additional reference number package which is to be screened.

h. Statistical Indicator Code. A code designating whether data submitted for screening is required for provisioning or other services (see DOD 4100.38-M).

30.23.2 Report processing.

a. Items may be excluded from the report by already having a screening result displayed in the DIC field, or by DLIS Screening Result Code. The TAPE option results in an 80-column file of part II information. The report is sequenced in ascending submitter control number.

b. The submitter control number is constructed from the PCCN/PLISN of the qualified record. The PLISN used is the lowest valued PLISN for the item within the selected PCCN/LCN range (the Same As PLISN field is blank). If no PCCN/PLISN is recorded for an item, then a Type "1" error is displayed. No rows of data for the item are placed on part II.

c. If Additional Reference Number Select (ARN SEL) is "YES" and if the item has more than 24 additional reference numbers, then error Type "2" is displayed. The first 24 ARNs in ascending reference number sequence are placed on part II of the report.

d. If a specific SOURCE CODE is selected and the SMR is not contained

against an item, at its first appearance, then error Type "3" is shown and the item is disqualified from part II.

e. If TYPE SCREEN CODE is "F" or "S", and if ARN SEL is "YES" and if an Additional Reference Number matches the prime Reference Number, then error type "4" is displayed. Only the duplicate ARN is disqualified from part II. In part II of the report, columns 41 and 42 are always left blank for "F" or "S" type screen.

f. If TYPE SCREEN CODE is "P", and if either the reference number category code (RNCC) or reference number variation code (RNVC) is missing for the reference number/CAGE (in HA) or if ARN SEL is "YES" and any additional reference number and CAGE (in HB), then error Type "5" is displayed. If the RNCC/RNVC is an ARN, only the ARN is disqualified from part II. If the RNCC/RNVC is the prime reference number, then the entire item is disqualified from Part II.

30.24 LSA-033, Preventive Maintenance Checks and Services (PMCS). This summary provides operator/crew and organizational level preventive maintenance task identification and description and equipment availability results. The PMCS are required for the operator and organizational level TMs and are based on the results of the reliability centered maintenance analysis. The report is selectable by either LCN range or TM code and number. The format is contained on figure 38. Spacing between rows and columns is not critical on this report.

30.24.1 Task interval values are interpreted as follows; "A", BEFORE; "D", DURING; "H", AFTER; "C", DAILY; "L", WEEKLY; "P", MONTHLY; "M", QUARTERLY; "N", SEMIANNUALLY; and "Q", YEARLY. If the interval is "B", then the maintenance interval (DED 208) and measurement base (DED 238) are displayed under the interval column. The measurement base is interpreted on the report, e.g., "S" is ROUNDS. If the report is selected by TM Code, tasks are qualified to the PMCS report by an associated PMCS indicator (Table CA). If the report is selected by LCN range, tasks are further qualified by maintenance level (Task Code, third position) of Crew or Organizational.

30.24.2 The report is sequenced in ascending Task Code Interval in the order contained in paragraph 30.24.1, then by ascending LCN. Each LCN is assigned a numeric item number beginning with "0001". An alphabetic sequence code beginning with "A" is assigned to each task against the same LCN with the same Task Code Interval. If the report is selected by LCN range, a page break is required between output of Operator/Crew level PMCS tasks and Organizational level PMCS tasks.

30.25 LSA-036, Provisioning Requirements. This report is a summary of those data recorded on the data tables identified for provisioning requirements. The summary contains that data required for review at various provisioning conferences (e.g., long-lead time items conference, provisioning conference, etc.) and is used in the selection procedures to identify repair parts requirements in support of the equipment to be fielded. The summary will satisfy the deliverables cited in MIL-STD-1388-1A. Format contained in table I and sample report on figure 39.

30.25.1 The following "header" data required to identify the specified list(s) are not a part of the LSAR, but are contained in the LSA-036 summary:

MIL-STD-1388-2B
APPENDIX B

- a. Procurement Instrument Identification (PII). A 19-position alphanumeric entry used to identify a specific contractual document. The PII includes the PII number (PIIN) (13 positions), and the supplementary PII number (SPIIN) (6 positions).
- b. Nomenclature of model or type number. A 21-position alphanumeric entry used to specify the name, model, or type of equipment being provisioned.
- c. Control Data. A 10-position alphanumeric entry used for control information as specified by the requiring authority. This information may consist of such items as identification of provisioning data in MIL-STD-1388-2 format or a Weapons System Code.
- d. Prime Contractor's CAGE. A five-position alphanumeric entry which identifies the prime contractor for the equipment being provisioned.
- e. Submission Control Code. A five-position numeric entry used to control the submission of provisioning data. The first submission will be 00001, and each subsequent submission is to be numbered sequentially, one greater than the prior submission.
- f. Date list submitted. A six-position numeric entry used to identify the date of submission. The first two positions will identify the year, the next two will identify the month, and the last two will identify the day.

30.25.2 DEDs for those data contained on the LSA-036 summary are contained in appendix E. The first card appearing on an LSA-036 list is the header record. Following this record, the LSA-036 report is sequenced by ascending PLISN in Binary-Coded-Decimal (BCD), or Extended BCD Interchange Code (EBCDIC) collating sequence. The PLISNs are then sequenced by ascending Card Format Indicator (CFI). Multiple CFIs are sequenced by Type of Change Code (TOCC) in the following order: blank, D, G, L, Q, and M. Finally, within the TOCC, items are sorted by ascending Card Sequence Number (CSN).

30.25.3 The report will display the following provisioning report control data:

- a. CSN. A two-position numeric code which is used to sequence multiple data input cards for a specific card format indicator. The initial card entry is coded 01. Subsequent cards are coded 02-99.
- b. CFI. A one-position alphabetic code: A-H, J-L used to identify a card format and content.
- c. Reference Designation Overflow Code (RDOC) (Card/Block, D/45, on the LSA-036 summary). A one-position alphabetic code: A and B used to link a long Reference Designation which exceeds 32 characters. Code "A" is entered against the first 32 characters, and code "B" is entered against the last 32 characters.
- d. Multiple-Configuration UOC. A one, two or three-position alphanumeric code that indicates the configuration(s) of a system/equipment on which the item under analysis is used based on the UOC (DED 501) assignments. The UOC is alphabetic in the sequence A-Z, followed by AA-ZZ (less Is and Os). A blank UOC indicates that the assembly/part is used in all configurations. For

MIL-STD-1388-2B
APPENDIX B

example:

If there were three different model designations (in table XC) for a given PCCN as shown below:

Model	UOC (DED 501)
(V)1	A
(V)2	B
(V)3	C

A single UOC is assigned to each item's application based on the number of model configurations that the LCN is used on (table HO). (The combination model UOCs (D, E, and F) are automatically generated.)

LCN	UOC	System/End Item
1A1	(blank)	(Used in all configurations)
1A2	A	(Used in (V)1 configuration only)
1A21	B	(Used in (V)2 configuration only)
1A3	C	(Used in (V)3 configuration only)
1A31	D	(Used in (V)1 and (V)2 configurations)
1A312	E	(Used in (V)1 and (V)3 configurations)
1A318	F	(Used in (V)2 and (V)3 configurations)

e. Quantity per End Item (QPEI) (DED 317). The QPEI (three options) may be computed during the LSA-036 report preparation using the formulas provided in the data definitions.

f. NHA PLISN (DED 258) and Overhaul Replacement Rate (ORR) (DED 281) Assignment. The NHA PLISNs may be assigned during the LSA-036 report preparation based on the item having a P- source code, an ORR entry, and a higher assembly PLISN having an SMR Code of P--D-. The base ORR of the item is multiplied by the Quantity per Assembly (QPA) for each succeeding indenture level. For example:

PLISN	IND	CD	SMR	QPA	NHA PLISN	NHA-IND	ORR
CFFF	F		PADZZ	0002	CEAA	N	005
CEAA	E		PAHDD	0002	CDEE	N	001
CDEE	D		PAHDD	0003	CCDD	N	
CCDD	C		PAFHH	0001	CB12	N	002
CB12	B		PAODD	0002	AAAA	E	001
AAAA	A		PAODD	0001			

For PLISN CFFF, the Overhaul PLISNs and associated ORRs are:

OVERHAUL PLISN	ORR
CDEE	015
CB12	030
AAAA	030

NOTE: PLISN CEAA is the item's immediate NHA PLISN. PLISN CCDD is disqualified because it is SMR Coded PAOHH.

MIL-STD-1388-2B
APPENDIX B

g. Same as PLISN (DED 364). The Same as PLISN may be assigned during the LSA-036 summary preparation.

h. Indenture Code (DED 162). The "A" indenture code (for the XB table system/end item) is assigned by the LSA-036 process.

30.25.4 LSA-036 Update and Design Change Notices. There are five basic types of LSA-036 updates which can result when LSAR data is added, changed, or deleted affecting provisioning lists (PL) previously delivered. These transactions can be automatically generated using a validated LSAR ADP system by establishing baseline records upon initial submission of the LSA-036. These transactions are based upon a comparison of the current LSAR provisioning oriented data tables and provisioning data baselined by a previous LSA-036 submittal.

a. Standard Data Update. For each LSA-036 card affected by data which has been added or changed since the previous PL delivery or LSA-036 update, mandatory data, i.e., PCCN, PLISN, CSN, and CFI, an "M" TOCC and the added/changed data only are entered. If data has been deleted, a "G" is entered in the TOCC and in the left most position of each field deleted on the appropriate LSA-036 card. Data deletions and changes/additions occurring on the same LSA-036 card will require both a change and deletion card for the appropriate data.

(1) If all data on an LSA-036 CFI is deleted, a delete transaction will be generated consisting of the PCCN, PLISN, CSN "01", CFI (except A), the key data associated with that CFI, and a "G" TOCC.

(2) When an entire PLISN record is deleted, a delete transaction will be generated consisting of the appropriate PCCN, PLISN, CAGE, Reference Number, and a "D" TOCC on the 01A card. Also, if the reference designation exists, it is displayed with the PCCN and PLISN on the 01D card with a "G" TOCC. In addition, if any change authority related information is changed, CFIs "F", "G", and "H" update transactions are also processed.

b. Quantity Data Update. If a quantity field is updated, mandatory data, a "Q" TOCC, and the updated quantity data field(s) are entered. This will only apply to the following data: QPA, QPEI, Total Quantity Recommended, Allowance Item Code Quantity, Minimum Replacement Unit, Recommended Initial System Stock Buy, Recommended Minimum System Stock Level, Recommended Tender Load List Quantity, Quantity Shipped, Quantity Procured and Prorated Quantity. If additional data displayed on the same LSA-036 card also changes during the update, only one change card is entered with TOCC "Q". If quantity data is deleted, a change card is entered with a zero filled quantity and TOCC "Q".

c. Key Data Update. Certain provisioning data are considered key and associated data elements and are listed below. Changes to key data requires the submission of both a delete and change card for the appropriate key data. The deletion card should contain a "G" TOCC and the original key data. The change card should contain an "M" TOCC with new key data and applicable associated data. Deletion of key data will result in deletion of the corresponding associated data.

<u>KEY DATA</u>	<u>ASSOCIATED DATA</u>
(1) CAGE and Additional Reference Number	RNCC and RNVC

MIL-STD-1388-2B
APPENDIX B

(2) NHA PLISN	ORR, NHA IND.
(3) UOC	None
(4) Reference Designation	RDOC RDC
(5) PLCC	None
(6) Change Authority Number	Serial Number Effectivity Prorated Exhibit Line Item Number Prorated Quantity IC, Replaced or Superseding PLISN, R/S Indicator, Design Change Notice (DCN) UOC, Total Item Changes Quantity Shipped Quantity Procured
(7) Serial Number Effectivity	None
(8) DCN UOC	None
(9) TM Code	Figure Number Item Number
(10) TM Code, Figure Number Item Number TM FGC	Basis of Issue (BOI) TM Change Number, TM Indenture Code Quantity per Figure
(11) TM Code Figure Number Item number	Provisioning Nomenclature
(12) BOI-Control	BOI-Quantity Authorized BOI-End Item, BOI-Level

d. Associated Data Update. Changes to associated data require the submission of a change card consisting of an "M" TOCC with the changed data and entry of the applicable key data. Deletion of associated data requires the submission of a deletion card with a "G" TOCC, a "G" in the left most position of the associated data field and entry of the key data.

e. DCN. DCN information is not distinguished from other updated data for a particular LSA-036 update using a validated LSAR ADP system. DCNs can be processed as a separate and distinguishable report by specifying that DCN affected data must be processed as an exclusive update, i.e., by performing an LSA-036 update, entering the DCN information into the LSAR, and again running an LSA-036 update. An option to obtain an LSA-036 report for updated data pertaining to a specific Change Authority Number is provided on the LSA-036 report options. DCN information updates are similar to other update transactions with the following exception: When a Change Authority Number and Serial Number effectivity are entered, an "L" TOCC is entered for the replaced item. If a quantity change occurs on a limited effectivity item, an "L" TOCC is entered in lieu of a "Q".

MIL-STD-1388-2B
APPENDIX B

30.25.5 Part II, Standard Edit List. This section is automatically produced when an LSA-036 is requested. The standard section lists those PLISNs matching the PCCN selected which were disqualified or would degrade the provisioning list. This list must be reviewed by the user to ascertain what corrections, if any, are needed to update the parts data tables for subsequent update(s) to the provisioning list.

30.25.6 Two optional part III listings are also available. Option 1 provides selectable provisioning data edits for Army customer use. Option 2 contains Air Force L card data formats to merge with the basic LSA-036 A-K cards.

30.26 LSA-037, Spares and Support Equipment Identification List. The purpose of this report is to provide information that identifies the investment spares (Section I), expense spares (Section II), support equipment (Section III), and tools and test equipment (Section IV) required for system support under contractor logistic support. Items qualify for a particular section based on ICCs:

- Investment Spare (ICC of X, AA)
- Expense Spare (ICC of Y, Z, 9, AB, AE)
- Support Equipment (ICC of G, H, 7, AD)
- Tool and Test Equipment (ICC of D, M, N, P, R, V, 1-6, 8, AC)

30.26.1 This summary may be selected by sections, a specific LCN range, and selected ICCs (which must qualify according to above criteria). Within each section, the report is sequenced by ascending manufacturer's part number. The format is contained on figure 40. Spacing between rows and columns is not critical on this report.

30.27 LSA-039, Critical and Strategic Item Summary. This report of items assigned a critical item code (CIC) or industrial materials analysis of capacity (IMAC) code. Part 1 of the report lists CIC items. Part 2 of the report lists IMAC items. The report may be selected for any CIC or may be selected for specific CIC or IMAC combinations. It may also be sequenced by LCN or reference number (part I), or by LCN or IMAC (part II). The format is contained on figure 41. Spacing between rows and columns is not critical on this report.

30.28 LSA-040, Authorization List Items Summary. This summary is divided into two options. The first option consists of four parts: components of end item, basic issue items list, additional authorization list, expendable durable supplies and materials list. The items are identified by code A in position 1 and the appropriate list code in position 2 of the Allowance Item Code (DED 017). These lists are required as source information to prepare an appendix to the operator's manual, or in combined operator's and maintenance manual (i.e., a -12, -13, or -14), as specified by MIL-M-63036, Manuals, Technical: Operator's, Preparation of. Each report part is listed in alphabetical sequence by Item Name. Option 2, stockage list type three, consists of three parts (each selectable); supply system responsibility, using unit responsibility, and collateral equipment. Items which belong in this summary will have an "E" in the first position of the Allowance Item Code (Allowance Type). Format is contained on figure 42. Spacing between rows and columns is not critical on this report.

30.28.1 Option 1, Part I, Components of End Item (COEI) List. This section

provides a listing of those items which are part of the end item. COEI are removed and separately packaged for transportation or shipment only when necessary.

30.28.2 Option 1, Part II, Basic Issue Items (BII) List. This section provides a listing of those minimum essential items required to place an equipment in operation, to operate it, and to perform emergency repairs. These items are removed and separately packaged for transportation.

30.28.3 Option 1, Part III, Additional Authorization List (AAL). This section provides a listing of those items which are not issued with an end item and are not listed/identified on the end item engineering drawings as part of the end item configuration.

30.28.4 Option 1, Part IV, Expendable/Durable Supplies and Materials List (ESML). This section provides a listing of those expendable/durable supplies and materials required to operate and maintain the equipment.

30.28.5 Option 2, Stockage List Type Three. This summary provides a listing of supply system and using unit responsible items; principal end items; and, collateral equipment identified by entries in the Allowance Item Code. The lists are used as source information to prepare stockage list type three TMs. It is sequenced by Allowance Item Code entries, EA and ED (supply system responsibility); then, EC (using unit responsibility) and EE (collateral equipment) items and by ascending reference designations. The CAGE listing is sequenced by ascending CAGE. Item Number is a numerically assigned sequence number beginning with "0001".

30.29 LSA-046, Nuclear Hardness Critical Item Summary. This summary provides a listing of all support items which are coded as nuclear hardness critical. The report can be prepared for a specific LCN range and is sequenced by either ascending reference number/CAGE or PCCN/PLISN. The format is contained on figure 43. Spacing between rows and columns is not critical on this report.

30.30 LSA-050, Reliability Centered Maintenance (RCM) Summary. This report is divided into three parts. The first part is the RCM analysis conducted on repairable items of a system by disposition, task code, and safety hazard severity code (SHSC). This part is selectable by SHSC(s) and sequenced by disposition only, disposition by maintenance level, or maintenance level only. The second part of the report is a management summary showing RAM characteristics of the item, preventive maintenance tasks, both table and calculated values for task frequencies, and the total man-hours associated with the SSC for a given maintenance level. This part is selectable and sequenced similar to part I with the addition of a sequence by SSC. The third part is used to evaluate the items that did not have an RCM analysis accomplished against them. It is also selectable by SHSC(s) and is sorted by ascending FMI values. The format is contained on figure 44. Spacing between rows and columns is not critical on this report.

30.30.1 In part 2, Task Frequency is calculated by using the formula provided under DED 430 for preventive tasks (method 1). The total number of man-hours is the summation of mean man-minutes per person identification for the identical SSC and O/M level.

30.30.2 When elapsed time and man-hours are reported, each number is preceded by (M) or (P) to designate either measured or predicted values, respectively. Where a measured value has not been input into the LSAR, the report will default to the predicted value.

30.30.3 When the failure rate is reported, it is preceded by (M), (P), (A), or (C) to indicate measured, predicted, allocated, and comparative analysis values, respectively. Where a measured value has not been entered, the report will default to the predicted, allocated, and finally comparative analysis.

30.31 LSA-056, Failure Modes, Effects and Criticality Analysis (FMECA) Report. This summary consists of three parts. The first part contains FMECA, criticality analysis, maintainability information, damage mode and effects analysis, and minimum equipment listing information, as specified by MIL-STD-1629. The second part is the criticality analysis information which is a listing in descending order of each item's computed criticality or failure mode criticality number by SHSC. This part is selectable by SHSC(s) and failure mode criticality numbers greater than a selected value. This part should be used to identify candidates for RCM analysis or design reviews. The third part is the failure mode analysis summary which consists of the failure modes and failure rates of each repairable item. The report should be used to identify failure modes which impact item criticality number and SHSC assignment. The format is contained on figure 45. Spacing between rows and columns is not critical on this report.

30.31.1 If part 1 of this report is selected, enter the SHSC (1, 2, 3, 4) of the failure modes which are of interest. If the SHSC field is left blank, then only SHSCs 1 and 2 will be considered. A selection must be made for either minimum Failure Probability Level or minimum Failure Mode Criticality Number. If both are selected, Failure Probability Level will be disregarded.

30.31.2 Parts 1 and 3, Item Criticality Number (Cr) is calculated using formulas contained in DEDs 178 and 133 (Failure Mode Criticality Number).

30.31.3 In Part 3, an edit check is made on this report to ensure that the sum of the failure mode ratios never exceeds 1.00 for a given LCN. If this occurs, an "****" will be printed out under the Failure Mode Ratio header.

30.31.4 When failure rate is reported, it is preceded by (M), (P), (A), or (C) to indicate measured, predicted, allocated, and comparative analysis values, respectively. Where a measured value has not been entered, the report will default to the predicted, then allocated, and finally comparative analysis. In part II, overflows of Reference Number exceeding 16 positions are printed on the next line immediately below the first position of the Reference Number.

30.31.5 Part 1 of the report is sequenced by ascending LCNs, FMIs, MPCs, then SHSCs. Part 2 is sequenced by ascending values of Failure Probability Level, then LCN. Part 3 is sequenced by ascending LCNs.

30.32 LSA-058, Reliability Availability and Maintainability Summary. This summary consists of two parts. The first part is the reliability summary redesign which provides a narrative description for an item on which a redesign is proposed. This part should be used to review potential candidates for redesign. The second part details the level of repair to be performed on

an item for all maintenance levels. This part is used to review the reliability and maintainability factors for the repair time of an item. The format is contained on figure 46. Spacing between rows and columns is not critical on this report.

30.32.1 In part 1 of the report, Failure Mode Criticality Number or Failure Probability Level may be used. However, Failure Mode Criticality Number should be used whenever possible. Also, if the LCN type of subject LCN is functional, then the reference number and CAGE may not appear. In part 2, the (P) or (M) preceding the elapsed time values represent predicted and measured, respectively. Measured values take precedence.

30.32.2 Part 1 of the report is sequenced by ascending LCNs, then FMIs. Part 2 is sequenced by maintenance level, then ascending LCNs and FMIs within each maintenance level.

30.33 LSA-065, Manpower Requirements Criteria. This summary provides manhour summary information by each task. The format is contained on figure 47. Spacing between rows and columns is not critical on this report.

30.33.1 The following formula applies for Mean Time Between Task Maintenance Actions (MTBTMA) and Man-Hours per Person Identifier (M-HRS PER PERS ID):

$$a. \text{ MTBTMA}_i = \frac{\text{Annual Operating Requirements}}{(\text{Task Frequency})_i}$$

Where: i = task code i

b. M-HRS PER PERS ID is computed by summing all subtask mean man-minutes per person identifier for each entry matching an identical person identifier and SSC and then dividing this value by 60.

30.33.2 The report displays the system/component reference number. Within each reference number, tasks are displayed by unscheduled/on equipment (task interval codes F, G, and J; and task operability codes A, B, C, D, and E); unscheduled/off equipment (task interval codes F, G, and J; and task operability Code G); and, scheduled (all task interval codes except F, G, J, and Y).

30.34 LSA-070, Support Equipment Recommendation Data (SERD). A report describing requirements for and of one piece of support equipment. This report will include administrative data, description of equipment, allocation data, design data, and Integrated Logistic Support (ILS) requirements as specified by MIL-STD-2097. Format contained in figure 48. Spacing between rows and columns is not critical on this report.

30.34.1 The E-CAGE/PN (Equivalent CAGE and Part Number) code in section 2 is generated based on whether or not the support equipment reference number and CAGE has equivalent part numbers and CAGEs. This is determined by searching the HB table additional reference numbers and CAGEs, and if any are found, a "Y" code is produced for this field; otherwise, an "N" code is produced. If any matches are found in table HB, they are output in section 2 (following the Articles Requiring Support section) under the heading of Equivalent CAGE/PN(s) (page 6 of the LSA-070 example).

30.34.2 The alternate NSN code in section 2 is generated based on whether or not any alternate NSNs exist on file for subject support equipment. This is determined by searching the EH table for valid entries. If any are found, a code of "Y" is generated and alternate NSNs are output in another part of section 2 under the heading alternate NSN (page 6 of LSA-070 summary).

30.34.3 Under the price data header in section 2, the design data and ILS values must equal the total design data price and total ILS price that are calculated in sections 4 and 5, respectively.

30.34.4 Under the header "shipping modes" in section 2, narrative explanation of the different modes of transportation for the piece of support equipment are explained. This information can be output only if the reference number and CAGE of the support equipment has been linked to an LCN and ALC for the support equipment. Once this link has been made, the information can be entered in, and subsequently pulled from, the JD table under the Transported End Item Narrative element (Transported End Item Narrative Code of "E").

30.34.5 Section 2 is sequenced by ascending reference number. Section 2, articles requiring support; and section 6, unit under test (UUT) related information will be sequenced by ascending LCNs. Section 6 (OTP, TPI, and AID) will be sequenced by ascending UUT LCNs, then ascending reference numbers.

30.35 LSA-071, Support Equipment Candidate List. This summary provides a consolidated listing of support equipment (SE) requirements divided into two sections. Section I contains active SE candidates and section II contains disapproved SE candidates. Section I is sequenced by end article LCN and Section II is sequenced by ascending reference number. The format is contained on figure 49. Spacing between rows and columns is not critical on this report.

30.35.1 Section II, disapproved support equipment candidates, is qualified by finding valid SE candidates within the specified LCN range with a status code (table EF) of "X". If the status code is not available, the qualified SE will be included in Section I.

30.36 LSA-072, Test Measurement and Diagnostic Equipment (TMDE) Requirements Summary. This report provides a two part summary of TMDE requirements and technical descriptions to verify the applicability of the test equipment for use on the weapon system/end item. This report can be selected by a range of LCNs, or by matching on the reference number and CAGE of subject piece of TMDE equipment. If this report is selected by a range of LCNs, the sequence will be ascending LCNs, then ascending reference numbers. The format is contained on figure 50. Spacing between rows and columns is not critical on this report.

30.36.1 The part I header, "TMDE item selected by", will show the reference number and CAGE selected if that option is chosen, or it will show the LCN and ALC which qualifies under the selected range of LCNs.

30.36.2 Under part II, Quantity is calculated by multiplying the values for number of activities by the quantity per activity (both values in ED table). Manual entries can be made at the end of part II for estimated type classification date, prepared by, and the date.

30.37 LSA-074, Support Equipment Tool List. This summary provides a listing consisting of four sections: tools currently in inventory; tools in inventory but not assigned to gaining unit; modified hand tools; and, peculiar tools requiring development. Each section can be selected by a limited number of ICCs. Section 1 is limited to group B ICCs (see DED 173); section 2 is limited to Group C ICCs; section 3 is limited to ICC of AC only, and, section 4 is limited to Group A ICCs. The format is contained on figure 51. Spacing between rows and columns is not critical on this report.

30.37.1 Part III, modified hand tools, assumes that a breakdown of the tool exists within the LSAR database. If so, "make from" items will include those items which are subordinate to subject tool in LCN structure and which have an Indenture Code greater than that of the tool (e.g., tool indenture code + 1).

30.37.2 Within each part of the report, an SE item is only listed once. If more than one qualified entry occurs for a piece of support equipment, all information must be consolidated. Each part of this report is sequenced by ascending reference number.

30.38 LSA-075, Consolidated Manpower, Personnel and Training Report. This summary provides a depiction of critical manpower and personnel data by maintenance level and new/modified skill requirements needed as a baseline for performing hardware-manpower requirements analysis. The format is contained on figure 52. Spacing between rows and columns is not critical on this report.

30.38.1 Available man-hours of 0.00 are significant as opposed to blank values which depict no person on file. If actual man-hours can be calculated, the available man-hours will be output even if blank. Actual man-hours are calculated by summing all mean man-minutes for a given SSC at a given maintenance level across all applicable tasks, then dividing by 60.

30.38.2 Actual quantity of an SSC at a given maintenance level can only be calculated correctly if a unique person identifier has been assigned to each maintenance person for the entire weapon system file and that relationship is carried out for all tasks. If this method is used, then the actual quantity is simply calculated by counting the different number of person identifiers for a given SSC at each maintenance level.

30.38.3 Section I is sequenced by ascending SSC, then by ascending maintenance level. Section II is sequenced by ascending original SSC, then by ascending new SSC.

30.39 LSA-076, Calibration and Measurement Requirements Summary (CMRS). This report details TMDE and the calibration standards and equipment required to assure traceability of measurements through the required metrology and calibration programs to approved National Standards as specified by MIL-STD-1839. The format is contained on figure 53. Spacing between rows and columns is not critical on this report.

30.39.1 Section I items consist of LCNs which have a CMRS Recommended Code (table UB) of 1 (Category I CMRS). Section II consists of Category II CMRS items with a parameter group code (PGC) that matches the PGC of the category I item and it also consists of calibration procedures (table EC) for the category II item. Section III consists of category III CMRS items which have

a PGC that matches the category II CMRS PGC. Section IV consists of a full breakdown of each CMRS category I item from section I and the corresponding sections II and III items associated with it. If a calibration procedure is identified for the category II CMRS item, this calibration procedure will be output under the category III header of Section IV. If a calibration procedure is not identified for the category II CMRS item, all qualifying category III CMRS items will be output under the category III header of section IV.

30.39.2 The "Page" number in section I is generated based on the page number that includes the section IV full breakdown of that category I item.

30.39.3 Section I of the report is sequenced by ascending LCNs. Sections II and III are sequenced by ascending reference number. Section IV is based on the sequence of section I.

30.40 LSA-077, Depot Maintenance Interservice Data Summary. This report contains three parts. Part I contains all depot repairable items and the applicable tasks which are performed at depot. This part is sequenced in ascending LCN. Part II, section A, provides a listing of all SE sequenced by ascending reference number and CAGE. Part II, section B, contains the new or modified depot facilities requirements sorted by ascending facility category code and facility name. Part III depicts depot SE and associated tasks requiring these support items. Part III is sequenced by ascending reference number and CAGE of the SE. Within the above sequence, tasks are sorted in ascending LCN and task code, and within task code by ascending person identifier code. Man-minutes are calculated by summing all subtask mean man-minutes for the identical person identifier in a given task. The format is contained on figure 54. Spacing between rows and columns is not critical on this report.

30.41 LSA-078, Hazardous Materials Summary. The report provides a summary of all hazardous materials required to support a selected end item. This summary identifies all items having associated hazardous materials storage, hazardous waste storage or disposal costs. This summary also identifies the maintenance tasks requiring quantities and costs per task. The summary is used to eliminate or reduce identified hazardous material items during the system design process. Format contained at figure 55. Spacing between rows and columns is not critical on this report.

30.41.1 The computed quantity is calculated by multiplying the task frequency times the quantity per task. The total quantity required is calculated by summing all computed quantity for a given reference number and CAGE.

30.41.2 The report is sequenced by ascending reference number and CAGE. Tasks are sorted in ascending LCN and task code.

30.42 LSA-080, Bill of Materials. Part I (Parts List) identifies each assembly and provides a listing of the items related to or contained in the assembly. The summary provides a vehicle for comparing the LSAR against the assembly drawings to ensure items in the topdown breakdown of the assembly are contained in the LSAR data tables. Part II (Error Listing) is automatically produced when the LSA-080 is requested. The format is contained on figure 56. Spacing between rows and columns is not critical on this report.

MIL-STD-1388-2B
APPENDIX B

30.42.1 The LSA-080 summary is selected by either UOC and either LCN range or PCCN. If the report is selected by LCN, the LCN-CODE should specify if the type of LCNs are either: classical or modified classical.

30.42.2 The LSA-080 report, part I, identifies parts to the assemblies of which they are contained. Each assembly will only show parts one indenture lower, e.g., a "C" indentured assembly will only show "D" indentured items. These items may be both repair parts and spares. If the item is a spare, a separate page breakdown of the item will appear on the report.

a. If the report is selected by LCN, then either the LCN structure, or LCN-IC and the LCN "values" are used to place items to assemblies. All items sorted in ascending LCN sequence, with either an LCN-IC or structure value of one indenture greater, are placed as items to an assembly until within the sorted range another item is found at the same indenture level, or greater than the assembly. Items at more than one indenture greater are "grouped" with the item (now assembly) immediately preceding this indenture change. ALC items are "grouped" together as an assembly/item set, if there is no indenture level missing between them. If an ALC item does not have a matching ALC, it is then "grouped" to the blank or basic assembly item.

b. If PCCN is selected, PLISN and IC are used to sort items to assemblies, with all items sorted in ascending PLISN sequence of one IC greater than the IC of the assembly PLISN record placed below the assembly PLISN, until an IC is encountered that is equal to or greater than the assembly IC. The NHA PLISN is a value found in table HH which is one indenture less than the item with a value closest to the item's PLISN value and without an NHA-Indicator of "*".

30.42.3 The part II is produced automatically when the LSA-080 report is requested and data errors are found. The report identifies the items having erroneous data, and provides a message describing the type of error found. The errors that the edit routine will detect are:

a. Error Code 1. If an item is SMR coded, with "Z" or "B" in the fourth position, but parts are contained below this item with source codes other than K- or XA, then this error is output (appears on part I with asterisks by both the assembly/part location).

b. Error Code 2. An item does not have an identifiable NHA, e.g., if the indenture structure lists the item as an "F" and the logical NHA by file sort is a "D", this error is output (part II only).

c. Error Code 3. No IC. This item appears on part II only, when the selection is made by PCCN. If the selection is by LCN, the item is shown on both parts I and II.

d. Error Code 4. An item whose SMR code is blank or incomplete (without 3rd/4th positions).

e. Error Code 5. If LCN-Code is "CLASSICAL" and duplicate LCNs are encountered, each duplicate receives this error message. The item(s) will appear on both parts I and II.

f. Error Code 6. The following are allowable SMR recoverability codes based on the repair code:

MIL-STD-1388-2B
APPENDIX B

If position 4 (repair) is:	position 5 (recoverability) must be:
Z	Z, A
O (2, 3, 4, 5, 6) Navy only	O, F, H, G, D, L, A
F	F, H, G, D, L, A
H	H, G, D, L, A
G	G, D, L, A
D	D, L, A
L	D, L, A
B	Z, A

g. An assembly is SMR coded repairable (e.g., SMR-4 is not Z or B) but has no parts breakout beneath it.

h. Items having the error codes 2 and 3 with PCCN selection are listed on the LSA-080, part II only. Other errors are flagged with "***" to the right of the line the error appears in part I and also displayed in part II. The error messages are displayed on part II.

30.42.4 The report is sequenced in either ascending assembly reference number and CAGE, or in ascending assembly PLISN and then components of assembly PLISNs based on the selection option specified.

30.43 LSA-085, Transportability Summary. This report provides information critical to the shipping and transport of major end items of equipment. It includes environmental and hazardous material information necessary for safe transport of an item by air, highway, rail, and sea. The format is contained on figure 57. Spacing between rows and columns is not critical on this report.

30.43.1 If the LCN type of subject LCN is functional, NSN and related data, reference number, and CAGE may not be available. Overflows of Reference Number exceeding 16 positions are printed on the next line immediately below the first position of the Reference Number. This report is sequenced by ascending LCNs.

30.44 LSA-126, Hardware Generation Breakdown Tree. This summary provides a concise summary of information pertaining to a system/equipment breakdown. Each item is blocked in and indented to the proper level in the hardware family tree and displayed by line relationship beneath the appropriate assembly in which the item is contained. The format is contained on figure 58. Spacing between rows and columns is not critical on this report.

30.45 LSA-151, Provisioning Parts List Index (PPLI). This summary provides a cross reference between reference numbers and the applicable PLISN of the provisioning list as required by MIL-STD-1388-1A. It provides a ready reference of usage and location within the provisioning list for a given reference number. The report can be generated in reference number, LCN, or PLISN sequence. Additional data which further describes the item at its usage level(s) are provided for the user's information (i.e., item name, quantities, SMR, etc.). The format is contained on figure 59. Spacing between rows and columns is not critical on this report.

30.46 LSA-152, PLISN Assignment/Reassignment. This summary provides a listing, by reference number, of PLISN, Indenture Code (IC), NHA PLISN, and PRIOR ITEM PLISN, assigned by the LSAR system based on parameters of the assignment select card. The summary will depict the file content before and after the assignments or reassignments are made (PLISNs are assigned using the EBCDIC collating sequence). As an option, this report can be used to assign provisioning related control and reference data to the LSAR Parts Master File. The format is contained on figure 60. Spacing between rows and columns is not critical on this report.

30.46.1 It is necessary that the LSAR be properly structured using either a uniform (nonbroken) LCN structure when applying either a classical or modified classical LCN assignment technique; or an LCN-IC (Table XB) assignment without missing or unlinked indenture levels, when LCNs are assigned using the sequential method. Using the LSA-080 report, the analyst can review the file for correct structure, or by using the LSA-152 report detect error conditions in file structure.

30.46.2 The LSA-152 report consists of two parts. Part I will only be output when an error in file structure is encountered, or when the PLISN assignment (with selected PLISN spacing) exceeds the limit of 9999 for the proposed assigned PMF candidates. When these occur, the error location in the file is depicted on the report with a display of the unlinked or remaining file segment. If an error condition does occur, the LSA-152 process will not assign any PLISNs, but will continue processing to determine whether additional error conditions exist in the file. Validated LSAR systems will be required to have the capability to produce an error listing for the LSA-152 report. However, the format, messages and explanation of those messages for the error listing is vendor dependent. Part II of the report reflects the results of the PLISN assignment/reassignment; only a Part I or a Part II will be produced in a processing cycle. Also, PLISN assignment must occur as an exclusive cycle .

30.46.3 The report selection for PLISN assignment occurs within a PCCN and optionally a Start and Stop LCN range. ALC is not a selection option. Alternate LCNs (ALCs other than basic - 00) must be considered when assigning the basic LCN PLISNs because alternates may have basic items as NHAs. A row in table HO creates the end item (XC) to part application (HG) relationship. One HG row cannot be related to multiple PCCNs except when the item is a subordinate end item. When the item is a subordinate end item, HO would have one row depicting the end item relationship (end item and item LCN-ALCs are the same), and one or more rows showing the relationship to the system. Having the end items located in the XC table, and the fact that no item except subordinate end items can be linked to more than one PCCN through table HO, makes the Suppression Indicator Code obsolete.

30.46.4 Since there are unlimited "correct" structuring techniques using the ALC, there is no system edit to detect errors in file structure when the ALC is utilized, other than missing an indenture level when the ALC is being sequenced to the "basic" LCN structure. ALC assignment errors, therefore, can only be detected by a manual review of the LSA-152 or LSA-080 reports.

MIL-STD-1388-2B
APPENDIX B

30.46.5 There is a wide range of options when using the PLISN assignment routine:

a. NHA PLISNs and/or ICs may be assigned to the PMF, if this option is selected on the 152 report.

(1) If the file is constructed using the classical/modified classical LCN assignment technique, the IC may be assigned, provided the LCN structure exists in the XA table. Asterisk ICs may be assigned to the parts file based on the ICC of "9" representing kit components being previously assigned (Table HG). An option is also available to assign a constant NHA PLISN indicator of "N" against each NHA PLISN assigned to the HH table.

(2) When a sequential LCN assignment method is utilized, the LCN structure field may be left blank in the XA table, and the LCN-ICs must be entered in the XB table in order to assign NHA PLISNs. The IC (Table HG) should be that of the provisioned end item, while the LCN-IC should be related to the system level in the LSAR.

b. When assigning PLISNs for a subordinate end item, the IC is not assigned to the HG table. For example, a separately provisioned end item at the "C" indenture to the system (LCN-IC, table XB) will have an IC of "A" come out on the LSA-152 and LSA-036 reports, but will keep its IC of "C" assigned under the system end item assignment. All components to the subordinate end item will still have their IC assigned as before. For example, a "D" indenture item under the "C" indenture subordinate end item will have a "B" IC assigned when PLISN assignment is run against the "C" indenture subordinate end item.

c. PLISNs may be assigned only to items that qualify by PTD Selection Code for a specified Provisioning List (PL) or lists (Table HG).

d. PLISNs may be assigned in either topdown (LCN) or Reference Number sequence. When PLISNs are assigned in Reference Number sequence, the system will lock out the option to assign NHA PLISNs/ICs.

e. PLISNs may be assigned as either all alphabetic, alphanumeric, numeric, or, first position alphabetic, then second through fourth position numeric.

f. A starting PLISN value may be specified on the report selection card.

g. PLISN values of "AAAA" through "AAAHZ" may be reserved for the system level and separately provisioned end items (Model Reserve). If this option is selected, a starting model PLISN value may be specified (within the given range). If none is selected, the first model PLISN assignment will be "AAAA".

h. PLISNs may be assigned to overlay old PLISN values established in the file; to overlay PLISNs and to move the old PLISN value to the Prior Item PLISN field; or to assign PLISNs only to items that do not have a PLISN value already established (insert) (Insert/Overlay selection on report). If the insert option is chosen, PLISNs already assigned to the file must match with the LCN structure or LCN-ICs of the selected LCN range.

i. It is possible to skip PLISN values between the assigned PLISNs for

MIL-STD-1388-2B
APPENDIX B

future use, when the item is impacted by Design Change Notice or Engineering Change Proposals, or for when the item having PLISNs assigned is not fully broken down to piece part level. This option cannot be utilized if the insert option (paragraph h) is in use. PLISN gaps may be as great as 1,121.

j. PLISNs may be assigned to items based upon the Data Status Code (Table HG) contained against the qualified item. This can be useful when performing incremental provisioning on an LSAR that is not fully mature.

30.47 LSA-154, Provisioning Parts Breakout Summary. This report provides a two-part summary of each reference number and can be utilized to assist in performance of the DOD Replenishment Parts Breakout Program. Included in part I of the report are critical pricing and breakout program information. It is sequenced in ascending reference number and CAGE. Part II contains selected parts application data and is sequenced in ascending LCN. If both parts are selected, a separate page of the report for each reference number and CAGE is prepared. If only part I is required, there is no page break between reference numbers. The report may be selected by contractor technical information codes, source codes, reference number or report parts. The format is contained on figure 61. Spacing between rows and columns is not critical on this report.

30.48 LSA-155, Recommended Spare Parts List for Spares Acquisition Integrated with Production (SAIP). This summary provides the data required for SAIP list, as specified by MIL-STD-1388-1A. Either the unit of measure or issue prices may be displayed and are presented by ascending reference number and CAGE. Items are qualified for the SAIP List based on entry of "Y" in the SAIP code (DED 391). The format is contained on figure 62. Spacing between rows and columns is not critical on this report.

LSAR REPORTS										
DATA ELEMENT TITLE	KEY	DED	CODE							
BASIS OF ISSUE END ITEM		30	RATIOBHM							
BASIS OF ISSUE LEVEL		30	LVLBOIHM							
TABLE HN										
END ITEM ACRONYM CODE	F	96	EIACODXA							
LCN TYPE	F	203	LCNTYPXB							
S/N PROVISIONING CAGE CODE	F	46	CAGEDH							
S/N PROVISIONING REFERENCE NUMBER	F	337	REFNUMHN							
S/N PROVISIONING LSA CONTROL NUMBER (LCN)	F	199	LSACONHN							
S/N PROVISIONING ALTERNATE LCN CODE (ALC)	F	19	ALTLCHN							
S/N PROVISIONING SYSTEM/EI LCN	F	199	LCNSEIHN							
S/N PROVISIONING SYSTEM/EI ALC	F	19	ALCSEIHN							
S/N PROVISIONING SERIAL NUMBER FROM	F	373	FRSNUMHN							
S/N PROVISIONING SERIAL NUMBER TO	F	373	TOSNUMHN							
TABLE HO										
END ITEM ACRONYM CODE	F	96	EIACODXA							
LCN TYPE	F	203	LCNTYPXB							
UOC PROVISIONING CAGE CODE	F	46	CAGEDHO							
UOC PROVISIONING REFERENCE NUMBER	F	337	REFNUMHO							
UOC PROVISIONING LSA CONTROL NUMBER (LCN)	F	199	LSACONHO							
UOC PROVISIONING ALTERNATE LCN CODE (ALC)	F	19	ALTLCHHO							
UOC PROVISIONING SYSTEM/EI LCN	F	199	LCNSEIHO							
UOC PROVISIONING SYSTEM/EI ALC	F	19	ALCSEIHO							
TABLE HP										
CAGE CODE	F	46	CAGEDXH							
REFERENCE NUMBER	F	337	REFNUMHA							
END ITEM ACRONYM CODE	F	96	EIACODXA							
LSA CONTROL NUMBER (LCN)	F	199	LSACONXB							
ALTERNATE LCN CODE (ALC)	F	19	ALTLCNXB							
LCN TYPE	F	203	LCNTYPXB							
CHANGE AUTHORITY NUMBER	K	43	CANUMBHP							
REPLACED OR SUPERSEDED (RS) (PLISN)			RSPLSHIP							
R/S PLISN INDICATOR			RSPINDHP							
INTERCHANGEABILITY CODE		172	INTCHHP							
TOTAL ITEM CHANGES		452	TOTICHHP							
QUANTITY SHIPPED		323	QTYSHHP							
QUANTITY PROCURED		322	QTYPROHP							
PRORATED EXHIBIT LINE ITEM NUMBER (ELIN)		305	PROELIHP							

X Appearing on output
 C Used in report computation

* Qualifying or processing
 F Data table foreign key

M Mandatory
 K Data table key

A Modified Element

FIGURE 14. LSAR data tables to report matrix

ANNUAL MAN-HOURS BY SKILL SPECIALTY CODE AND LEVEL OF MAINTENANCE

EIAC	LCN NOMENCLATURE	START LCN	ALC TYPE	STOP LCN	UC	SERV DES	SSC	SSE	PARTS
REFRIG-UNT	REFRIGERATION UNIT	0	F		DCY	ARMY			BOTH

NUMBER OF SYSTEMS SUPPORTED BY MAINTENANCE LEVEL:

OPERATOR/CREW	(C): 5000
ORGANIZATIONAL/AVUM/ON EQUIP	(O): 5000
INTERMEDIATE/DS AVIM/AFLOAT/OFF EQUIP	(F): 5000
INTERMEDIATE/GS/ASHORE	(H): 5000
ASHORE AND AFLOAT (NAVY)	(G): 0
SPECIALIZED REPAIR ACTIVITY	(L): 5000
DEPOT/SHIPYARD	(D): 5000

PART I - MAN-HOUR SUMMARY

SSC	OPERATOR/ CREW (C)	ORGANIZATIONAL/ ON EQUIP (O)	INTERMEDIATE/DS- AVIM/AFL/OF EQP (F)	INTERMEDIATE/ GS/ASHORE (H)	INTERMEDIATE/ NAVY ASH/AFL (G)	SPECIALIZED REPAIR ACT (L)	DEPOT/ SHIPYARD (D)
35B20	0.00	2770.00	0.00	0.00	0.00	0.00	0.00
35B30	0.00	3440.00	1759.15	0.00	0.00	0.00	0.00
44B10	0.00	0.00	213.50	0.00	0.00	0.00	0.00
44E10	0.00	0.00	1186.60	0.00	0.00	0.00	0.00
52C10	0.00	24.57	315.00	0.00	0.00	0.00	0.00
52C20	0.00	614.30	1219.20	0.00	0.00	0.00	0.00
76J10	0.00	0.00	0.00	0.00	127.00	0.00	1005.15

TOTAL NUMBER OF MAINTENANCE TASKS: 33

PART II - PERSONNEL SKILL AND TASK SUMMARY

SSC	LCN NOMENCLATURE	LCN-TYPE	ALC TASK CD	TASK IDENTIFICATION	TASK FREQ	MB SSE ID	PERS ID	TRG EQP	M-H PER PERS ID	ANL M-H/ ITEM	TOTAL ANL M-H	FGC
35B20	002 WIRE HARNESS ASSY	F	GGOAGAA	INSTALL WIRE HARNESS ASSY	.2000	O	AAA	N	0.67	0.13	670.00	02
	00204 LIGHT ASSEMBLY	F	HGOAAAA	REPLACE LIGHT ASSY	.8400	O	AAA	N	0.50	0.42	2100.00	0204
35B30	002 WIRE HARNESS ASSY	F	GGOAGAA	INSTALL WIRE HARNESS ASSY	.2000	O	AAF	N	1.34	0.27	1340.00	02
	00201 POWER CONTROL ASSY	F	JGFOGAA	REPAIR POWER CONTROL	.2330	O	ABB	Y	1.51	0.35	1759.15	0201
	00204 LIGHT ASSEMBLY	F	HGOAAAA	REPLACE LIGHT ASSY	.8400	O	AAF	N	0.50	0.42	2100.00	0204

FIGURE 15. LSA-001 Summary

MAINTENANCE SUMMARY

EIAC LCN NOMENCLATURE START LCN ALC STOP LCN UOC SERV DES AOR MB PEACE/WAR
 REFRIG-UNIT REFRIGERATION UNIT 0 00 DCY AIR FORCE 007200 O

ORGANIZATIONAL INSPECTIONS

REQUIRED STATUS	DAILY INSP		PREOP INSP		POSTOP INSP		PERIODIC INSP		MISS PROF CHG		TURNAROUND	
	M-H	ELAP	M-H	ELAP	M-H	ELAP	M-H	ELAP	M-H	ELAP	M-H	ELAP
.00	.25	.00	.25	.25	.15	.00	.51	.51	1.00	1.15	.00	.00
.00	.00	.00	.00	.00	.00	.00	.28	.03	.00	.00	.00	.00

MAINTENANCE LEVEL CREW/OP

REQUIRED STATUS	UNSCH MAINT		MAX TIME TO REPAIR	ANNUAL M-H PER END ITEM		M-H PER OPER HOUR	
	M-H	ELAP		SCHED	UNSCHED	SCHED	UNSCHED
.00	.00	.00	.00	.0	.0	.00	.00
.00	.00	.00	.00	.5	.5	.00	.00

MAINTENANCE LEVEL ORG

REQUIRED STATUS	UNSCH MAINT		MAX TIME TO REPAIR	ANNUAL M-H PER END ITEM		M-H PER OPER HOUR	
	M-H	ELAP		SCHED	UNSCHED	SCHED	UNSCHED
.00	.00	.00	.00	.0	.0	.00	.00
1.68	1.54		.00	5.1	5.1	.00	.00

MAINTENANCE LEVEL INT(F)

REQUIRED STATUS	UNSCH MAINT		MAX TIME TO REPAIR	ANNUAL M-H PER END ITEM		M-H PER OPER HOUR	
	M-H	ELAP		SCHED	UNSCHED	SCHED	UNSCHED
4.00	4.00		5.00	75.0	18.0	.02	.05
.69	.53			.0	1.9	.00	.00

STATUS TOTALS FOR ALL MAINT LEVELS: ANNUAL M-H PER END ITEM M-H PER OPER HOUR

SCHEDULED	0.5	0.00
UNSCHEDULED	7.0	0.00
TOTAL M-H PER END ITEM	7.5	0.00

FIGURE 16. LSA-003 Summary

LSA-004 MAINTENANCE ALLOCATION CHART

SELECTION SUMMARY

EIAC	LCN NOMENCLATURE	START LCN	ALC	STOP LCN	UOC	SERV DES
REFRIG UNIT	ENGINE ASSY	006			FF	ARMY

ITEM CATEGORY CODES SELECTED: A, B, C

TOOL LIST OPTION: YES

TECHNICAL MANUAL CODE: TM2

TECHNICAL MANUAL DESIGNATION: TM 5-4110-234-14

DRAFT/PROOF OPTION SELECTED: PROOF MAC

DISPLAY OPTION: TECHNICAL MANUAL FUNCTIONAL GROUP CODE

FIGURE 17. LSA-004 Summary

DRAFT MAINTENANCE ALLOCATION SUMMARY

EIAC LCN NOMENCLATURE START LCN ALC STOP LCN UOC SERV DES ICC SELECTION TM CODE TOOL LIST
 REFRIG UNT ENGINE ASSY 006 UOC FF ARMY B,X,Y,Z TM2 YES
 TECH MANUAL DESIGNATION DISP OPT
 TM 5-4110-234-14 LCN

LCN	ALC LCN NOMENCLATURE	MAINTENANCE FUNCTION	C	O	F	H	G	L	D	TOOLS AND EQUIPMENT
006	ENGINE ASSY	TEST	.00	.00	.77	.00	.00	.00	.00	
		SERVICE	.06	.00	.00	.00	.00	.00	.00	
		FAULT LOCATIO N	.00	.78	.00	.00	.00	.00	.00	3,4,7
00602	ENGINE BLOCK	REMOVE	.00	.00	.54	.00	.00	.00	.00	1,5,7
0060201	PISTON ASSY	REPAIR	.00	.00	.56	.00	.00	.00	.00	6,8,9,10, 11,12,13, 14
00607	B SUPER CARB	REMOVE AND RE PLACE	.00	1.38	.00	.00	.00	.00	.00	3,5,7,15 17
		REPAIR	.00	.00	1.50	.00	.00	.00	.00	
00614	STARTER ASSY	REMOVE AND RE PLACE	.00	.00	.61	.00	.00	.00	.00	2,7,17
		REPAIR	.00	.00	.35	.00	.00	.00	.00	2,7,18

FIGURE 17. LSA-004 Summary - continued

DRAFT TOOL AND TEST EQUIPMENT REQUIREMENTS

TOOL/TEST EQUIPMENT REF CODE	MAINTENANCE CATEGORY	ITEM NAME	NATIONAL STOCK NUMBER	REFERENCE NUMBER	CAGE
1	F	WRENCH, SOCKET	5120-00-449-8083	AT503	11599
2	F	WRENCH, SOCKET	5120-00-148-7917	B107-6	80204
3	O	SOCKET SET 3/8 INCH		B2502	10702
4	O	COMPRESSION GAUGE	5210-00-278-1248	GGG-G-17 TY9CL2STA123	80244
5	O,F	SCREWDRIVER	5120-00-222-8852	GGG-S-121	81348
6	F	SPREADER, PISTONRING		JH25	44940
7	O,F	TOOL KIT GEN REFRIG	5180-00-596-1474	SC5180-90-CL-N14	50980
8	F	RING, RETAINING		112-0003	44940
9	F	PIN, PISTON		112-0069	44940
10	F	PISTON	2805-00-647-0713	112-0136	44940
11	F	RING SET, PISTON	2805-01-045-3095	113-0153	44940
12	F	BUSHING, CONN ROD		114-0036	44940
13	F	BEARING, ROD (HALF)		114-0145	44940
14	F	CONNECT ROD, PISTON	2805-00-865-2333	114-0203	44940
15	O	KIT, GASKET		142-0033	44940
16	O	CARBURETOR	2910-01-044-8999	142-0431	44940
17	F	STARTER ASSY	2920-01-043-8778	191-1052	44940
18	F	CLUTCH ASSY	3010-01-008-9140	191-1087	44940

FIGURE 17. LSA-004 Summary - continued

MAINTENANCE ALLOCATION CHART

TM 5-4110-234-14

(1) GROUP NUMBER	(2) COMPONENT/ ASSEMBLY	(3) MAINT FUNCTION	(4) MAINTENANCE CATEGORY				(5) TOOLS AND EQUIPMENT	(6) REMARKS
			C	O	F	H	D	
06	ENGINE ASSY	TEST	.0	.0	.8	.0	.0	
		SERVICE	.1	.0	.0	.0	.0	
		REPLACE	.0	1.5	.0	.0	.0	1,2,3,9, A 11,13
		REPAIR	.0	.8	.0	.0	.0	.0 6,8
0601	DELUXE CARB	SERVICE	.0	.0	.3	.0	.0	.0 5,7
		REPLACE	.0	1.2	.0	.0	.0	.0 6,10
0602	ENGINE BLOCK	REM/INS	.0	.0	.5	.0	.0	.0 1,10
0602	SUPER CARB	REPLACE	.0	1.4	.0	.0	.0	.0 6,10
060201	PISTON ASSY	REPAIR	.0	.0	1.5	.0	.0	.0 B
		REPAIR	.0	.0	.6	.0	.0	.0 12,14,15, 16
0607	CARBURETOR ASSY	ADJUST	.0	.5	.0	.0	.0	
		SERVICE	.0	.0	.2	.0	.0	.0 5,7
		REPAIR	.0	.0	1.0	.0	.0	
0614	STARTER ASSY	REPLACE	.0	.0	.6	.0	.0	.0 4
		REPAIR	.0	.0	.4	.0	.0	.0 4

FIGURE 17. ISA-004 Summary - continued

TOOL AND TEST EQUIPMENT REQUIREMENTS

TM 5-4110-234-14

TOOL/TEST EQUIPMENT REF CODE	MAINT CATEGORY	NOMENCLATURE	NATIONAL/NATO STOCK NUMBER	TOOL NUMBER
1	O,F	WRENCH, SOCKET	5120-00-449-8083	AT503
2	O	SCREWDRIIVER	5120-00-278-1273	A135
3	O	SOCKET	5120-00-189-7985	A24
4	F	WRENCH, BOX	5120-00-148-7917	B107-6
5	F	TONGS		B25
6	O	SOCKET WRENCH		B2502
7	F	BUCKET WITH LID		CTB1
8	O	COMPRESSION GAUGE	5210-00-278-1248	GGG-G-17 TY9CL2S 1234
9	O	PLIERS	5120-00-293-0032	GGG-P-471
10	O,F	SCREWDRIIVER	5120-00-222-8852	GGG-S-121
11	O	EXT, SOCKET WRENCH	5120-00-243-1697	GGG-W-641
12	F	SPREADER, PISTONRING		JH25
13	O	SCREW STARTER, HAND	5120-00-832-6221	SN9
14	F	SET, SOLDERING	5820-00-347-8650	4003100
15	F	COMPRESSOR, RING	5480-00-123-9876	4003100
16	F	LEAK DETECTION DEV	3420- - -	4990866

FIGURE 17. ISA-004 Summary - continued

MAINTENANCE ALLOCATION CHART

TM 5-4110-234-14

SECTION IV. REMARKS

REFERENCE CODE	REMARKS
A	DS WILL REPLACE PHENOLIC CONNECTOR AND POT FOR MOISTURE.
B	ALL REPAIR AND REPLACEMENT OF PARTS PERFORMED BY ORGANIZATIONAL MAINTENANCE LIMITED TO AUTHORIZED ITEMS LISTED IN TM 9-4240-1643-24P.

MAINTENANCE ALLOCATION CHART

TM 5-4110-234-14

(1) GROUP NUMBER	(2) COMPONENT/ ASSEMBLY	(3) MAINT FUNCTION	(4) MAINTENANCE CATEGORY AVUM AVIM DEPT	(5) TOOLS AND EQUIPMENT	(6) REMARKS
06	ENGINE ASSY	TEST	.0 .8 .0	.0	(1), (2)
		REPLACE	1.5 .0 .0	1,2,3,9, 11,13	
		REPAIR	.8 .0 .0	.0 6,8	(3), A
0601	DELUXE CARB	SERVICE	.0 .3 .0	.0 5,7	
		REPLACE	1.2 .0 .0	.0 6,10	
0602	ENGINE BLOCK	REM/INS	.0 .5 .0	.0 1,10	
0602	SUPER CARB	REPLACE	1.4 .0 .0	.0 6,10	
		REPAIR	.0 1.5 .0	.0	A
060201	PISTON ASSY	REPAIR	.0 .6 .0	.0 12,14,15, 16	
0607	CARBURETOR ASSY	ADJUST	.5 .0 .0	.0	
		SERVICE	.0 .2 .0	.0 5,7	
		REPAIR	.0 1.0 .0	.0	
0614	STARTER ASSY	REPLACE	.0 .6 .0	.0 4	
		REPAIR	.0 .4 .0	.0 4	

FIGURE 17. LSA-004 Summary - continued

TOOL AND TEST EQUIPMENT REQUIREMENTS

TM 5-4110-234-14

TOOL/TEST EQUIPMENT REF CODE	MAINT CATEGORY	NOMENCLATURE	NATIONAL/NATO STOCK NUMBER	TOOL NUMBER
1	AVUM/AVIM	WRENCH, SOCKET	5120-00-449-8083	AT503
2	AVUM	SCREWDRIVER	5120-00-278-1273	A135
3	AVUM	SOCKET	5120-00-189-7985	A24
4	AVIM	WRENCH, BOX	5120-00-148-7917	B107-6
5	AVIM	TONGS		B25
6	AVUM	SOCKET WRENCH		B2502
7	AVIM	BUCKET WITH LID		CTB1
8	AVUM	COMPRESSION GAUGE	5210-00-278-1248	GGG-G-17 TY9CL2S 1234
9	AVUM	PLIERS	5120-00-293-0032	GGG-P-471
10	AVUM/AVIM	SCREWDRIVER	5120-00-222-8852	GGG-S-121
11	AVUM	EXT, SOCKET WRENCH	5120-00-243-1697	GGG-W-641
12	AVIM	SPREADER, PISTONRING		JH25
13	AVUM	SCREW STARTER, HAND	5120-00-832-6221	SN9
14	AVIM	SET, SOLDERING	5820-00-347-8650	4003100
15	AVIM	COMPRESSOR, RING	5480-00-123-9876	4003100
16	AVIM	LEAK DETECTION DEV	3420- - -	4990866

FIGURE 17. ISA-004 Summary - continued

MAINTENANCE ALLOCATION CHART

TM 5-4110-234-14

SECTION IV. REMARKS

X150 ENGINE

REFERENCE
CODE

REMARKS/NOTES

- (1) DIAGNOSTIC INSPECTION USING BORESCOPE
- (2) FUNCTIONAL TEST AT AVIM - ENGINE IN METS
- (3) REPAIR AT AVIM INCLUDES THE COMPLETE ENGINE ASSEMBLY, INDIVIDUAL LINE REPLACEMENT UNITS (LRU) (ACCESSORIES) AND MODULES.

FIGURE 17. LSA-004 Summary - continued

SUPPORT ITEM UTILIZATION SUMMARY

EIAC LCN NOMENCLATURE START LCN ALC STOP LCN UOC SERV DES ITEM CATEGORY CODES T/Q OPTION
 REFRIG UNT CARBURETOR ASSEMBLY 00607 00 007 FF ARMY Z,B ELAPSED TIME

DISPLAY OPTION
 LCN

SUPPORT ITEM
 REFERENCE NUMBER: SC5189-90-CL-N14-2345 CAGE: 44940 ITEM NAME: TOOL KIT GEN REFRIG ITEM CATEGORY CODE: Z

M/L LCN ALC LCN NOMENCLATURE TM FUNCT GROUP CODE
 DS 00614 00 STARTER ASSY 0614

TASK CD	TASK IDENTIFICATION	TASK FREQ	MB	ELAP TIME	MAN-HOURS	QTY/TA	UM
JGFAGAA	REPAIR STARTER ASSY	.3330	O	.35 (M)	.35 (M)	1.00	EA
HGFAGAA	REPLACE STARTER ASSEMBLY	.3330	O	.61 (M)	.61 (M)	1.00	EA

TOTAL ELAPSED TIME USAGE FOR SUPPORT EQUIPMENT FOR MAINTENANCE LEVEL: DS .32
 TOTAL ELAPSED TIME USAGE FOR SUPPORT EQUIPMENT FOR ALL MAINTENANCE LEVELS .32

SUPPORT ITEM
 REFERENCE NUMBER: B107-6 CAGE: 44940 ITEM NAME: WRENCH, BOX ITEM CATEGORY CODE: 4

M/L LCN ALC LCN NOMENCLATURE TM FUNCT GROUP CODE
 DS 00614 00 STARTER ASSY 0614

TASK CD	TASK IDENTIFICATION	TASK FREQ	MB	ELAP TIME	MAN-HOURS	QTY/TA	UM
JGFAGAA	REPAIR STARTER ASSY	.3330	O	.35 (M)	.35 (M)	1.00	EA
HGFAGAA	REPLACE STARTER ASSEMBLY	.3330	O	.61 (M)	.61 (M)	1.00	EA

TOTAL ELAPSED TIME USAGE FOR SUPPORT EQUIPMENT FOR MAINTENANCE LEVEL: DS .32
 TOTAL ELAPSED TIME USAGE FOR SUPPORT EQUIPMENT FOR ALL MAINTENANCE LEVELS .32

SUPPORT ITEM
 REFERENCE NUMBER: B25 CAGE: 44940 ITEM NAME: TONGS ITEM CATEGORY CODE: 4

M/L LCN ALC LCN NOMENCLATURE TM FUNCT GROUP CODE
 DS 00607 00 CARBURETOR ASSY 0607

TASK CD	TASK IDENTIFICATION	TASK FREQ	MB	ELAP TIME	MAN-HOURS	QTY/TA	UM
CGFAGAA	SERVICE CARBURETOR	3.3360	O	1.70 (M)	.20 (M)	1.00	EA

TOTAL ELAPSED TIME USAGE FOR SUPPORT EQUIPMENT FOR MAINTENANCE LEVEL: DS 5.67
 TOTAL ELAPSED TIME USAGE FOR SUPPORT EQUIPMENT FOR ALL MAINTENANCE LEVELS 5.67

FIGURE 18. LSA-005 Summary

CRITICAL MAINTENANCE TASK SUMMARY

EIAC LCN NOMENCLATURE START LCN ALC STOP LCN UOC SERV DES DISPLAY OPTION
 REFRIG UNIT REFRIGERATION UNIT 0 UOC DCY AIR FORCE TM FUNCTIONAL GROUP CODE

CRITICAL CRITERIA 1. THE FOLLOWING TASKS EXCEED 2.0000 FOR TASK FREQUENCY

2. THIS REPORT COVERS THE FOLLOWING MAINTENANCE LEVELS: ALL

3. THIS REPORT COVERS UNSCHEDULED TASKS ONLY

TM FGC	ALC LCN NOMENCLATURE	REFERENCE NUMBER	CAGE	TASK CD	IDENTIFICATION	TSK FREQ	MB	LCN
00	REFRIGERATION UNIT AM700	F100000RG-245CK4	94833	HGOAAAA	REPLACE REFRIGERAT ION UNIT	4.0540	0	0
0607	CARBURETOR ASSY	142-0431	44940	CGFAGAA	SERVICE CARBURETOR	3.3360	0	00607
0607	CARBURETOR ASSY	142-0431	44940	DGOAAAA	ADJUST CARBURETOR	3.3360	0	00607
06	ENGINE ASSY	CCKA-MS/3834J	44940	HGDAXAA	REPLACE ENGINE ASS Y	3.3330	0	006
06	ENGINE ASSY	CCKA-MS/3834J	44940	NGOAAAA	FAULT LOCATION - E NGINE ASSY	3.3090	0	006
05	COMPRESSOR ASSY	5D43-139-A	10855	HGFAAAA	REPLACE COMPRESSOR ASSY	2.0000	0	005

FIGURE 19. LSA-006 Summary

SUPPORT EQUIPMENT REQUIREMENTS BY SKILL SPECIALTY CODE AND MAINTENANCE LEVEL

EIAC LCN NOMENCLATURE START LCN ALC STOP LCN UOC SERV DES ICC SSC M/L
 REFRIG UNT ENGINE ASSY 006 00608 FF NAVY 4 52C20 O

SEQ OPT DISP OPT
 M/L-SSC LCN

M/L	SSC	ITEM NAME	REFERENCE NUMBER	CAGE	LCN	ALC TASK CD	TASK IDENTIFICATION	TM	FGC
ORG	52C20	CLOTHS	A-A-531	04643	006	HGOXAAA	REPLACE ENGINE ASS Y	06	
		ADJUSTABLE WRENCH	AT503	41947	006	HGOXAAA	REPLACE ENGINE ASS Y	06	
		SOCKET SET 3/8 INCH	B2502	41947	00607	HGONGAA	REPLACE CARBURETOR ON ENGINE ASSEMBLY	0607	
		TOOL KIT GEN REFRIG	SC5180-90-CL-N14-1234	44940	006	CBONAAA	CHANGE OIL AND OIL FILTER	06	
		TOOL KIT GEN REFRIG	SC5180-90-CL-N14-1234	44940	006	HGOXAAA	REPLACE ENGINE ASS Y	06	
		TOOL KIT GEN REFRIG	SC5180-90-CL-N14-1234	44940	00607	HGONGAA	REPLACE CARBURETOR ON ENGINE ASSY	0607	
		SEALANT, GASKET	S023	10855	00607	HGONGAA	REPLACE CARBURETOR ON ENGINE ASSEMBLY	0607	
		FILTER, OIL	122-0323	10855	006	CBONAAA	CHANGE OIL AND OIL FILTER	06	
		KIT, GASKET	142-0033	10855	00607	HGONGAA	REPLACE CARBURETOR ON ENGINE ASSY	0607	

FIGURE 20. LSA-007 Summary

SUPPORT ITEMS VALIDATION SUMMARY

EIAC LCN NOMENCLATURE START LCN ALC STOP LCN UOC SERV DES M/L SEL ICC SELECTED
 REFRIG UNT ENGINE ASSY 006 DCY ARMY O Z, B, X

SUPPORT/TEST EQUIPMENT AND TOOLS

M/L	ICC	REFERENCE NUMBER	CAGE	ITEM NAME	QTY/TASK	UM	SUPPORT LCN	ALC	TASK CD	TASK FREQ	MB	SSC	HMPC
ORG	4	AT503	41947	ADJUSTABLE WRENCH	1.00	EA	006	HGOXAAA		3.3370	O	52C10	B
ORG	4	AT503	41947	ADJUSTABLE WRENCH	1.00	EA	006	HGOXAAA		3.3370	O	52C20	B
ORG	4	GGG-G-17 -1234	10855	COMPRESSION GAUGE	1.00	EA	006	NGOAAAA		3.3090	O	52C20	C
ORG	4	GGG-P-471	96906	PLIERS	1.00	EA	006	HGOXAAA		3.3370	O	52C10	B
ORG	4	GGG-P-471	96906	PLIERS	1.00	EA	006	HGOXAAA		3.3370	O	52C20	B
ORG	4	GGG-W-641	41947	EXT, SOCKET WRENCH	1.00	EA	006	HGOXAAA		3.3370	O	52C10	B
ORG	4	GGG-W-641	41497	EXT, SOCKET WRENCH	1.00	EA	006	HGOXAAA		3.3370	O	52C20	B
ORG	4	SN9	96906	SCREW STARTER, HAND	1.00	EA	006	HGOXAAA		3.3370	O	52C20	B
ORG	4	SN9	96906	SCREW STARTER, HAND	1.00	EA	006	HGOXAAA		3.3370	O	52C10	B
SPARE AND REPAIR PARTS													
ORG	X	CCKA-MS/3834J	44940	ENGINE	1.00	EA	006	HGOXAAA		3.3370	O	52C20	B
ORG	X	CCKA-MS/3834J	44940	ENGINE	1.00	EA	006	HGOXAAA		3.3370	O	52C10	B
ORG	Z	SC5180-90-CL-N14 -1234	44940	TOOL KIT GAN REFRIG	1.00	EA	006	HGOXAAA		3.3370	O	52C10	B
ORG	Z	SC5180-90-CL-N14 -1234	44940	TOOL KIT GAN REFRIG	1.00	EA	006	HGOXAAA		3.3370	O	52C20	B
ORG	Z	SC5180-90-CL-N14 -1234	44940	TOOL KIT GAN REFRIG	1.00	EA	006	NGOAAAB		3.3090	O	52C20	C

OTHER

FIGURE 21. LSA-008 Summary

SUPPORT ITEMS VALIDATION

EIAC	ITEM NAME	START LCN	ALC	WUC	IND	ITEM NAME	SM	SM	ICC	UM	QTY/EI	UM-PRICE	PS/	QTY/ASY	SMR	SL		
REFRIG-UNT	REFRIGERATION UNIT	0	00	05AA	PLISN	CD	NAT	STOCK	NUMBER	CC	IC	PLT	PC	U	0	0		
44940	A12316142F-110	00	05AA		A90B10	C	4130-01-091-9159	COMPRESSOR ASSY	9	B	X	EA	00001	1239.74	U	0001	PAOFF	0
00506					AACG							12						
51440	CCG45/1842-11AC	00	0520		A90B10	C	5120-01-096-3211	POWER SUPPLY	4	X	X	EA	00002	327.25	U	0001	PAFDD	0
00501					ABA3							07						
31560	LP1213980F-1000	00	06		A90B10	B	ENGINE, GASOLINE	3150-00-976-9349	9	X	X	EA	00001	2156.69	U	0001	PAODD	0
006					AAAK							15						
54330	12398/1842-11AC	00	0512A		A90B10	C	CABLE, ASSEMBLY	5120-01-097-4322	9	A	X	EA	00001	19.39	U	0001	PAFDD	0
00512AA					AC12							04						
29871	189.0918	00	0312		A90B10	F	SCREW, CAP	5302-01-000-0542	9	A	Y	EA	00001	0.03	U	0001	PAODD	0
0031028AL					AV19							01						
54330	19698/1842-12AD	00	0514A		A90B10	C	CABLE, ASSEMBLY	5120-00-398-4322	9	A	X	EA	00001	21.34	U	0001	PAFDD	0
0051209AD					AC28							04						

ITEM CATEGORY CODES SELECTED:

X, Y, AA, AC

PTD LISTS SELECTED

PPL SFPP LITIL RIL ISIL TTEL CBIL PCL SCPL ARA ARB
 YES NO YES NO NO NO NO NO NO NO NO NO

FIGURE 22. LSA-009 Summary

PARTS STANDARDIZATION SUMMARY

EIAC LCN NOMENCLATURE START LCN ALC STOP LCN UOC CTIC AMC DISPLAY OPTION
 REFRIG UNIT REFRIGERATION UNIT 0 00 K 3,2 REFERENCE NO

REFERENCE NUMBER	CAGE	ITEM NAME	FSC	C C L C	CTIC	CAGE(S)	UM PRICE	LOT QUANTITY	UM FY	OPTION
								FROM TO		
112-0069	44940	3 2 PIN, PISTON	2805	1 2 N	CK	81348 05472 96906 92392	26.00	1 10000	EA 90	N Y
112-0136-ABCDEF-123456	44940	5 9 PISTON, INT COMB EN	2805	1 2 A	CK	81348 05472 96906 92392	9.99	1 10000	EA	Y
113-0153	44940	3 2 RING SET, PISTON	2805	1 2 A	CK	81348 05472 96906 92392	2.53	1 10000	EA	Y
114-0036	44940	3 2 BUSHING, CONNec ROD	5 2	A	CK	81348 05472 96906 92392	3.20	1 10000	EA	Y
114-0145	44940	4 2 BEARING, ROD (HALF)	1 3	A	CK	81348 05472 96906 92392	4.20	1 10000	EA	Y
114-0203	44940	3 2 CONNECTING ROD, PIST	1 3	N	CK	81348 05472 96906 92392	136.99	1 10000	EA	Y

FIGURE 23. LSA-010 Summary

REQUIREMENTS FOR SPECIAL TRAINING DEVICE

EIAC	LCN NOMENCLATURE	START LCN	ALC	STOP LCN	UC	SERV DES	DISPLAY OPTION								
REFRIG UNIT	REFRIGERATION UNIT	0		00614	DCY	ARMY	LCN								
LCN	ALC	LCN NOMENCLATURE	TASK CD	IDENTIFICATION	TASK FREQ	MB	ELAP TIME	SSC	MAN-HOURS	TM	FGC				
0		REFRIGERATION UNIT	HGOAAAA	REPLACE REFRIGERAT ION UNIT	4.0540	0	.46	52C20	.46	00					
		REFRIGERATION UNIT	HGOAAAA	REPLACE REFRIGERAT ION UNIT	4.0540	0	.46	52C10	.17	00					
		REFRIGERATION UNIT	NGCAAAAC	FAULT LOCATION - N OISY OPERATION	5.4050	0	.37	76J20	.37	00					
001		DOOR-SCREEN ASSY	AGOABAA	INSPECT FOR DAMAGE	.8250	0	.09	76J10	.09	01					
00102		DOOR SIDE LEFT	HGOABAA	REPLACE DOOR	.5720	0	.19	52C20	.19	0102					
002		WIRE HARNESS ASSY	ABOACAA	ORGANIZATIONAL INS P OF WIRES/CABLES	.3000	0	.10	52C10	.10	02					
		WIRE HARNESS ASSY	BGDAGAA	TEST WIRE HARNESS ASSY	.2000	0	.37	35B30	.37	02					
		WIRE HARNESS ASSY	RGDAGAA	REMOVE WIRE HARNES S ASSY	.2000	0	.50	35E20	.50	02					
00501		VALVE PLATE ASSY	AGFAGAA	INSPECT VALVE PLAT E ASSY	1.2240	0	.10	52C20	.10	0501					
006		ENGINE ASSY	CBCACAA	CHECK ENGINE OIL L EVEL	900.0000	0	.06	76J10	.06	06					
0060201		PISTON ASSY	JGFXGAA	REPAIR PISTON ASSY	.2330	0	.56	52C20	.56	060201					
00607		CARBURETOR ASSY	DGOAAAA	ADJUST CARBURETOR	3.3360	0	.50	52C20	.56	0607					

FIGURE 24. LSA-011 Summary

EIAC LCN NOMENCLATURE START LCN STOP LCN UOC SERV DES RPT TYP FCC
 REFRIG-UNT REFRIGURATION UNIT 0 00 P DCY ARMY
 FACILITY NAME FACILITY CATEGORY CODE FACILITY CLASS FACILITY DRAW REV FDC AREA FACILITY FA COST UM OF CP
 LEXINGTON ARMY DEPOT 12333 REFRIG REPAIR FAC BR54910-09234235 AC DLN 15000 SF 20000 SF
 123-045

TASK LCN	ALC	TASK CODE	TASK IDENTIFICATION	TASK FREQ	MB	ELAPSED TIME
002	BGDAGAA	TEST WIRE HARNESS ASSEMBLY	.2000	0	.37 (M)	
006	JGDAGAA	REPAIR WIRE HARNESS ASSEMBLY	.2000	0	1.36 (P)	
	HGOXAAA	REPLACE ENGINE ASSEMBLY	3.3370	0	1.68 (M)	

1. FACILITY LOCATION:
 LEXINGTON, KENTUCKY, BUILDING 4, BAY A.
2. FACILITY CAPABILITY:
 THIS BAY CAN HANDLE UP TO 100 REFRIGERATION UNITS WITHOUT ANY PROBLEMS.
3. FACILITIES MAINTENANCE REQUIREMENTS:
 NONE.
4. FACILITIES REQUIREMENTS FOR OPERATIONS:
 120 VOLT POWER SUPPLY.
5. FACILITIES REQUIREMENTS FOR TRAINING:
 2 WORK AREAS SHOULD BE SET ASIDE FOR TRAINING.
6. FACILITY REQUIREMENTS; SPECIAL CONSIDERATIONS:
 NONE.
7. FACILITY REQUIREMENTS; SUPPLY/STORAGE:
 NONE.
8. FACILITY DESIGN CRITERIA:
 MUST REMIRE BAY FOR 40 120 VOLTS SPACED EVENLY ALONG THE WALLS.
9. FACILITY INSTALLATION LEAD TIME:
 NONE.

FIGURE 25. LSA-012 Summary

REQUIREMENTS FOR FACILITY

10. FACILITY TASK AREA BREAKDOWN:

THE TESTING OF THE WIRE HARNESS ASSEMBLY IS DONE IN AREA 3 WHICH IS A 10 BY 15 FOOT TEST BED CUBICAL. IF THE TESTING PROVES THAT THE WIRE HARNESS IS DEFECTIVE IT IS REPAIRED IN AREA 4 WHICH IS 10 BY 10 FOOT. REPLACE THE ENGINE ASSEMBLY IN AREA 6 WHICH IS 20 BY 20 FOOT.

11. FACILITIES UTILIZATION:

THERE WILL BE 24 TEST AND REPAIR TASKS DONE AT THIS FACILITY.

12. FACILITIES REQUIREMENTS:

NONE.

13. FACILITY UNIT COST RATIONALE:

NONE.

14. FACILITY JUSTIFICATION:

THERE IS NOT A FACILITY AT THIS TIME THAT HAS THE CAPABILITY TO REPAIR REFRIGERATION UNITS. THE LEXINGTON FACILITY HAS THE SPACE AVAILABLE AND THE PERSONNEL TO REPAIR THE UNITS.

15. TYPE OF CONSTRUCTION:

THE REWIRING OF THE FACILITY SHOULD TAKE APPROXIMATELY 3 MONTHS.

16. UTILITIES REQUIREMENT:

NONE.

SUPPORT EQUIPMENT:

ITEM NAME	NSN	REFERENCE NUMBER	LENGTH	WIDTH	HEIGHT	UM	WEIGHT	UM	QTY	UM
LAYOUT TABLES	FSC TBD TBD	44-6578-A123	120.0	60.0	42.0	IN	75.0	LB	3.00	EA
AC/DC	IPS	IPS PER	PHASE	WATTS						
	FRMAX	FRMIN	ORMAX	ORMIN	MAX RIPPLE					

FIGURE 25. LSA-012 Summary - continued

SUPPORT EQUIPMENT GROUPING UTILIZATION SUMMARY

EIAC LCN NOMENCLATURE START LCN ALC STOP LCN UOC SERV DES UOC SERV DES M/L SELECTED DISP OPT
 REFRIG UNIT REFRIGERATION UNIT 0 ALC STOP LCN DCY AIR FORCE 200 F O LCN

SUPPORT EQUIPMENT GROUPING IDENTIFICATION NUMBER: 200

M/L	LCN	ALC	LCN NOMENCLATURE	TASK CD	TASK IDENTIFICATION	TASK FREQ	MB	ELAP TIME	MAN-HOURS	TM	FGC
ORG	0		REFRIGERATION UNIT	HGOAAAA	REPLACE REFRIGERAT ION UNIT	4.0540	0	.46 (M)	.17 (M)	00	
	006		ENGINE ASSY	HGOXAAA	REPLACE ENGINE ASS Y	3.3370	0	1.68 (M)	1.51 (M)	06	
	006		ENGINE ASSY	NGOAAAA	FAULT LOCATION - E NGINE ASSY	3.3090	0	.78 (M)	.78 (M)	06	
	00607		CARBURETOR ASSY	DGOAAAA	ASJUST CARBURETOR	3.3360	0	.50 (P)	.50 (P)	0607	
DS	006		ENGINE ASSY	BGFAGAA	TEST ENGINE ASSY A FTER REPAIR	3.3370	0	.77 (P)	.77 (P)	06	
	00602		ENGINE BLOCK	RGFAGAA	REMOVE ENGINE FROM ENGINE ASSY	.3370	0	.54 (M)	.54 (M)	0602	
	0060201		PISTON ASSY	JGFXGAA	REPAIR PISTON ASSY	.2333	0	.56 (P)	.56 (P)	060201	
	00607		CARBURETOR ASSY	JGFXGAA	REPAIR CARBURETOR	.8400	0	1.00 (M)	1.00 (M)	0607	
	00607		CARBURETOR ASSY	CGFAGAA	SERVICE CARBURETOR	3.3360	0	1.70 (M)	.20 (M)	0607	
	00614		STARTER ASSY	JGFAGAA	REPAIR STARTER ASS Y	.3330	0	.35 (M)	.35 (M)	0614	
	00614		STARTER ASSY	HGFAGAA	REPLACE STARTER AS SY	.3330	0	.61 (M)	.61 (M)	0614	

FIGURE 26. LSA-013 Summary

TRAINING TASK LIST

EIAC LCN NOMENCLATURE START LCN ALC STOP LCN UOC SERV DES SSC TRAINING RECOMMENDED
 REFRIG UNT ENGINE BLOCK 00602 00608 DCY ARMY ALL YES

 SSC LCN 00607 ALC LCN NOMENCLATURE TSK FREQ MB TASK CD IDENTIFICATION TRAINING RECOMMENDED TM FGC
 46B10 B SUPER CARB 1.8400 O HGOAGAA REPLACE CARBURETOR OJT 0602
 ON ENGINE ASSY

TASK CONDITIONS TM/TO USE NOT REQUIRED
 SPECIAL TOOLS REQUIRED

PERFORMANCE STANDARDS PRECISION REQUIRED
 TIME STANDARD

RATIONALE FOR TRAINING TASK LEARNING DIFFICULTY
 RECOMMENDATION IMMEDIACY OF PERFORMANCE
 TASK DELAY TOLERANCE
 PROBABILITY OF DEFICIENT PERFORMANCE

RATIONALE FOR TRAINING PERCENT OF TOTAL TIME SPENT PERFORMING THE TASK
 LOCATION PERCENT OF WORK FORCE PERFORMING THE TASK
 THEORY, PRINCIPLES, OR VERBALIZED CONCEPTS REQUIRED
 FIELD EQUIPMENT AVAILABLE FOR TRAINING PURPOSES

SSC LCN 00602 ALC LCN NOMENCLATURE TSK FREQ MB TASK CD IDENTIFICATION TRAINING RECOMMENDED TM FGC
 52C20 ENGINE BLOCK .3370 O RGFAGAA REMOVE ENGINE FROM OJT 0602
 ENGINE ASSY

TASK CONDITION

PERFORMANCE STANDARD SUPERVISION REQUIRED

RATIONALE FOR TRAINING IMMEDIACY OF PERFORMANCE
 RECOMMENDATION

RATIONALE FOR TRAINING FIELD EQUIPMENT AVAILABLE FOR TRAINING PURPOSES
 LOCATION

FIGURE 27. LSA-014 Summary

PRELIMINARY MAINTENANCE ALLOCATION CHART

EIAC LCN NOMENCLATURE START LCN ALC TYPE STOP LCN UOC SERV DES TOOL LIST PART LIST SEQUENCE
 REFRIG-UNT REFRIGERATION UNIT 0 00 P 44940 FI000ORG-300 1 0.0231 1 PAOHH 00

ICC(S) TOOL LIST: A, B, C ICC(S) PART LIST: Y, AA, AB

PART I

MAINTENANCE ALLOCATION

NUMBER LCN ALC IC ITEM NAME CAGE REFERENCE NUMBER QPA MRR-I EC SMR TM-FGC
 0001 0 00 A REFRIGERATION UNIT 44940 FI000ORG-300 1 0.0231 1 PAOHH 00

TASK FUNCTIONS: M-HRS TOOL REFERENCES:

INSPECT (C) 0.25 (P) 0007, 0009
 TEST (O) 0.33 (M) 0003, 0001, 0005
 REPLACE (O) 0.75 (P) 0002, 0003, 0005, 0006
 REPAIR (O) 0.40 (P) 0003, 0004, 0007
 REPAIR (F) 0.87 (P) 0004, 0008, 0009, 0011
 REPAIR (H) 1.25 (P) 0005, 0006, 0007, 0008, 0009, 0010, 0012

PART REFERENCES:

0002, 0011
 0003, 0004, 0005, 0009
 0003, 0008, 0009, 0011, 0012
 0001, 0004, 0005, 0007, 0008
 0009

NUMBER LCN ALC IC ITEM NAME CAGE REFERENCE NUMBER QPA MRR-I EC SMR TM-FGC
 0002 001 00 B DOOR, SCREEN ASSEM 10825 32198/89-12 2 0.1312 1 PAFFF 01

TASK FUNCTIONS: M-HRS TOOL REFERENCES:

INSPECT (C) 0.08 (M) 0005
 REPLACE (F) 0.25 (M) 0005, 0009, 0013, 0014
 REPAIR (F) 0.67 (M) 0003, 0008, 0010, 0012

PART REFERENCES:

0003, 0009, 0010
 0003, 0005, 0012, 0013

NUMBER LCN ALC IC ITEM NAME CAGE REFERENCE NUMBER QPA MRR-I EC SMR TM-FGC
 0003 002 00 B WIRE HARNESS ASSEM 31280 12190-7892 1 1.0022 1 PAFDD 02

TASK FUNCTIONS: M-HRS TOOL REFERENCES:

INSPECT (C) 0.05 (P)
 REPLACE (F) 0.67 (P) 0016, 0017,
 REPAIR (D) 1.33 (P) 0003, 0008, 0009, 0010, 015

PART REFERENCES:

0003, 0009
 0006, 0014, 0015, 0016

FIGURE 28. LSA-016 Summary

PRELIMINARY MAINTENANCE ALLOCATION CHART

PART II

TOOLS LIST

TOOL NO.	CAGE	REFERENCE NUMBER	ITEM NAME	O/M LEVELS
0001	31290	AT503	ADJUSTABLE WRENCH	H
0002	21988	AT35	SCREWDRIIVER	O
0003	55389	A24	SOCKET	O, F
0004	71980	B107-6	WRENCH, SOCKET	O, D
0005	32190	B25	TONGS	F
0006	44978	B2502	SET, SOCKET, 3/8 I	C, O, F, H
0007	31201	CTB1	BUCKET WITH LID	O
0008	11908	GGG-P-471	PLIERS	C
0009	87965	GGG-S-121	TABLE, CABLE FORMI	F, D
0010	54310	GGG-W-64F1	EXTENSION, SOCKET	F, H, D
0011	32500	JM25	SPREADER, DOOR JAM	F
0012	98024	SC5180-90-CL-N14/23P (V)	TOOL KIT, GENERAL	F
0013	76505	SN9	SOLDERING IRON	F
0014	12298	121-098/34	HAMMER	F
0015	12280	12298	MULTIMETER	D
0016	32190	12980-349	WORKBENCH	F
0017	12134	131098/MVR-T	GAUGE, COMPRESSION	F

FIGURE 28. LSA-016 Summary - continued

PART III

PARTS LIST

PART NO.	CAGE	REFERENCE NUMBER	ITEM NAME	LCN	ALC	O/M LEVELS	SMR
0001	44940	B19109	COUPLING, FEMALE	0AG	00	H,	PAHZZ
0002	21988	D8977	GAUGE, TEMPERATURE	0AL	00	O	PAOZZ
0003	32890	E12908	SCREW, CAP HEXAGON	0AC	00	O, F	PAOZZ
			001AD	001AD	00	F	PAFZZ
			002AY	002AY	00	F	PAFZZ
0004	12897	GG1389/231451234 32198	VALVE, SUCTION	0AQ	00	O	PAOZZ
0005	89702	G1209865	NUT, TUBE, COUPLIN	0A8	00	O, H	PAOZZ
0006	98076	Z98076/32	CABLE, CONNECTOR	002AI	00	D	PADZZ
0007	23198	119807-23	VALVE, PLATE	0AR	00	H	PAHZZ
0008	44908	119907	RING, RETAINER	0AN	00	F	PAFZZ
0009	32890	12098/E	WASHER, LOCK	0AD	00	O, F, H	PAOZZ
			001AE	001AE	00	F	PAFZZ
			002AZ	002AZ	00	F	PAFZZ
0010	21897	14098-LP	HINGE, MECHANICAL	001AU	00	F	PAFZZ
0011	32198	15109/09	BULB, ELECTRIC LI	0BA	00	F	PAFZZ
0012	98012	22190/23	SWITCH, ELECTRIC	0BF	00	F	PAFZZ
0013	12190	3421AAUL	SPACER, 1/4 INCH	001A4	00	F	PAFZZ
0014	33218	441-8976	CABLE, INSULATED	002AN	00	D	PADZZ
0015	33218	441-9801/2	CABLE, THREE WIRE	002AW	00	D	PADZZ
0016	33218	441-99102	CONNECTOR, ELECTR	002AX	00	D	PADZZ

FIGURE 28. LSA-016 Summary - continued

EIAC JOB SELECTION
MLAI TANK COMMANDER

DUTY (JOB)

TASK IDENTIFICATION

SUBTASK IDENTIFICATION
ELEMENT NARRATIVE

PREPARE STATION FOR OPERATION (COMMANDER)

POWER UP COMMANDER'S STATION
CLIMB ON TANK
ENTER COMMANDER'S STATION
SET AND HOLD MASTER POWER SWITCH
ENSURE CWS POWER/MANUAL LEVER IS IN POWER POSITION
SET AND HOLD TURRET POWER/ENGINE-ON/MANUAL
AUX. POWER/ENGINE-OFF
CHECK COMMANDER'S PANEL SWITCHES
REPLACE PANEL LAMPS
ADJUST PANEL LAMP BRIGHTNESS
CHECK WARNING LIGHTS ON COMMANDER'S PANEL

OPERATE COMMANDER'S HATCH
RAISE/LOWER CWS HATCH TO PROTECTED
RAISE COMMANDER'S CWS HATCH FULL OPEN
CLOSE CWS HATCH

ADJUST COMMANDER'S SEAT/PLATFORM
ADJUST SEAT LINED UP WITH CWS & GPS
ADJUST COMMANDER'S KNEE GUARD
OPERATE COMMANDER'S DOME LIGHT
ADJUST FOOTREST BAR

OPERATE RADIO SET WITH INTERCOM
CONNECT/DISCONNECT HELMET & INTERCOM
OPERATE INTERCOM WITH REMOTE SWITCH
OPERATE INTERCOM W/O REMOTE SWITCH
TURN RADIO SET ON/SELECT FREQUENCY

PERFORM PRE-TARGET ENGAGEMENT ACTIVITIES (COMMANDER)

SUPERVISE CREW
PLAN NAVIGATION/ORIENTATION
COMMUNICATIONS (EXTERNAL)
RECONNAISSANCE/SURVEILLANCE ACTIVITY
C31
PLANNING/EVALUATION

FIGURE 29. LSA-018 Summary

DUTY (JOB)

TASK IDENTIFICATION
SUBTASK IDENTIFICATION
ELEMENT NARRATIVE

MONITOR (INTERNAL)
 CDR'S PANEL MOUNTING, LIGHTS, CONTROL
 CDR'S PANEL WARNING LIGHTS
 CDR'S WEAPON STATION

PREPARE TO FIRE ACTIVITIES
 MAIN GUN
 COAXIAL (M-240) MACHINEGUN

OPERATE AUXILIARY SYSTEMS

COMMUNICATIONS (INTERNAL)
 COMMUNICATE WITH OTHER CREW MEMBERS
 TARGET ACQUISITIONS COMMUNICATIONS

POST OPERATIONS ACTIVITIES (COMMANDER)

PERFORM AFTER OPERATIONS CHECKS

 SUPERVISE POST OPERATIONS PMCS
 ADJUST GPSE
 TEST .50 CAL FIRING MECHANISM
 TEST TURRET POWER TRAVERSE OPERATION
 CHECK TURRET OVERRIDE CAPABILITY
 TRAVERSE CWS USING POWER HANDLE
 TRAVERSE CWS MANUALLY
 ELEVATE/DEPRESS .50 CAL W/CRANKHANDLE
 FIELD STRIP .50 CAL & CHECK PARTS
 CLEAN & LUBRICATE .50 CAL

FIGURE 29. LSA-018 Summary - continued

EIAC LCN NOMENCLATURE START LCN ALC STOP LCN TYPE UOC SERV DES M/L SELECT ICC SELECTION
 REFRIG UNIT ENGINE BLOCK 00602 P DCY ALL ALL ALL

DISP OPT TASK NARRATIVE SELECTION HARDNESS CRITICAL PROCEDURES SELECTION TASK INTERVAL TASK FUNCTION
 LCN YES NO

LCN ALC REFERENCE NUMBER 142-0431ALCA CAGE ITEM NAME 33647 ENGINE BLOCK TM FUNCT GROUP CODE 0601

TASK CD TASK IDENTIFICATION HCP HMPD TSK FREQ MB LSAR ELAP TIME MANUALLY MEASURED ELAPSED TIME
 RGFAGAA REMOVE ENGINE FROM ENGINE ASSY S D .3370 O .82 (M)

SUBTASK NUMBER	TEXT	SEQUENCE CODE	SEQUENTIAL TASK NARRATIVE	WORK AREA	PERS ID	MAN MINUTE	MAN ELAP TIME
001	REMOVE THE RINGS FROM THE PISTON USING THE PISTON RING SPREADER.	1	REMOVE THE RINGS FROM THE PISTON USING THE PISTON RING SPREADER.	A	A	5.0	5.0
002	CLEAN PISTON RING GROOVES WITH THE END OF A BROKEN RING.	1	CLEAN PISTON RING GROOVES WITH THE END OF A BROKEN RING.	A	A	5.0	5.0
003	REMOVE THE PISTON PIN RETAINER FROM EACH SIDE.	1	REMOVE THE PISTON PIN RETAINER FROM EACH SIDE.	A	A	8.0	8.0
004	REMOVE TWO SCREWS SECURING THE CARBURETOR TO THE MANIFOLD.	1	REMOVE TWO SCREWS SECURING THE CARBURETOR TO THE MANIFOLD.	A	A	10.0	10.0
005	INSPECT THE PISTONS FOR FRACTURES AT THE RING LANDS SKIRTS AND PIN BOSSES.	1	INSPECT THE PISTONS FOR FRACTURES AT THE RING LANDS SKIRTS AND PIN BOSSES.	A	A	3.0	3.0
006	INSTALL NEW RINGS ON THE PISTON USING A PISTON RING SPREADER.	1	INSTALL NEW RINGS ON THE PISTON USING A PISTON RING SPREADER.	A	A	10.0	10.0
007	ATTACH CONNECTING ROD BY REINSTALLING PISTON PIN AND PIN RETAINERS.	1	ATTACH CONNECTING ROD BY REINSTALLING PISTON PIN AND PIN RETAINERS.	A	A	8.0	8.0

SSC SS EVAL PERSON ID LSAR MAN-HOURS MANUALLY MEASURED MAN-HOURS
 52C20 E A .82 (M)

SUPPORT/TEST EQUIPMENT AND TOOLS	ACTUAL QUANTITY USED	MANUAL EVALUATION
ICC ITEM NAME REFERENCE NUMBER	CAGE QTY/TASK	MANUAL EVALUATION
4 PISTON SPREADER PS5180-91-CN-N1532	10855 1.00	
SPARE AND REPAIR PARTS		

ICC ITEM NAME	REFERENCE NUMBER	ACTUAL QUANTITY USED	MANUAL EVALUATION
X PISTON	143-0431	44940 1.00	
OTHER			

ICC ITEM NAME REFERENCE NUMBER ACTUAL QUANTITY USED MANUAL EVALUATION

SUPPORT ITEMS NOT IDENTIFIED IN LSAR

ICC ITEM NAME REFERENCE NUMBER ACTUAL QUANTITY USED MANUAL EVALUATION

REVIEWER'S NAME

FIGURE 30. LSA-019 Summary

MAINTENANCE PLAN SUMMARY
PART I SYSTEM/END ITEM R&M REQUIREMENT

EIAC LCN NOMENCLATURE START LCN ALC TYPE STOP LCN UOC SERV DES ICC SELECTED RPT PT W/P
 REFRIG-UNIT REFRIGERATION UNIT 0 00 P 0 DCY ARMY BZQY YYYX X
 TM FGC ALC LCN LCN NOMENCLATURE REFERENCE NUMBER CAGE ITEM DESIGNATOR CODE HCI SC SEC
 00 00 0 00 0 F100000RG-2223-1 94833 TYPE001 MODEL00002 SR SUFFIXO B 4
 1334-FGR

FROM	TO	FROM	TO	FROM	TO	FROM	TO	FROM	TO
0012	002349								
AOR	MB	AOR	MB					MSN	DUR
7200	O	300	D	10	T			1	D
AI	AA	AO		MTBF	MTBR	MB	MTTR	MAMDT	MAX
97.000000	95.000000	90.000000	TECH	350.0	75.0	125.0	0	1.0	7.50
			OPER	500.0	90.0		0	.35	
			TECH	0.5	0.1	.15	D	.25	.7
			OPER	0.4	0.1		D		
			TECH	14.6	3.1	4.2	T		
			OPER	12.0	2.9		T		

MAINTENANCE CONCEPT:

INSPECTION/FAULT LOCATION TO BE ACCOMPLISHED BY CREW MAINTANANCE, WITH FOLLOW-ON INSPECTION/FAULT LOCATION AND REPLACEMENT OF DOOR-SCREEN AND ENGINE ASSEMBLIES PERFORMED BY ORGANIZATIONAL MAINTENANCE. DIRECT SUPPORT TASKED WITH REPLACEMENT OF COMPRESSOR AND REPAIR OF ALL ASSEMBLIES EXCEPT THE WIRE HARNESS, WHICH REQUIRES THE ATTENTION OF DEPOT MAINTENANCE.

MAINTENANCE PLAN RATIONALE:

NONE AT THIS TIME.

FIGURE 31. LSA-023 Summary

MAINTENANCE PLAN SUMMARY
PART II RELIABILITY AND MAINTAINABILITY

EIAC	LCN NOMENCLATURE	START LCN	ALC	LCN	ALC	TYPE	STOP LCN	UOC	SERV DES	ICC	SELECTED	RPT PT	DISP
REFRIG-UNIT	REFRIGERATION UNIT	0	00	0	00	P	0	DCY	ARMY	BZQY	YYYY	XXXX	OPT W/P
													X

TM FGC	LCN NOMENCLATURE	ALC	LCN	NSN AND RELATED DATA	REFERENCE NUMBER	DISP
00	REFRIGERATION UNIT	00	0	-4110-01-074-5174-	F100000RG-2223-11334-FGR	CAGE
						94833

CONV	MACT	MAC	SMR	UI	UNIT OF	QPA
FACTOR					ISSUE PRICE	
00001					5876.00	1

RAM INDICATOR CODE: ALLOCATED

TECH	MTBF	426.2	0	MB	MTBMA	7.1	0	MB	MTEM-INH	7.1	MB	MTBM-IND	MB	MTBM	NO	DEF	MB	MTBPM	7.2	0	MB	MTBR	10.4	0	MB	
OPER		588.1	0			12.2																				

TECH	MTTR	5.18		MAX	TTR	5.30		PCTL	95
------	------	------	--	-----	-----	------	--	------	----

OPER 4.10

FIGURE 31. LSA-023 Summary - continued

PREVENTIVE MAINTENANCE REQUIREMENTS SUMMARY

EIAC	LCN NOMENCLATURE	START LCN	ALC TYPE STOP LCN	ALC	NO SSC	M-H PER SSC	ELAP TIME	SKILL LEVEL	SSC	TRN REC EQP	TRN LCN	RPT PT YYYY	DISP OPT W/P
REFRIG-UNT	REFRIGERATION UNIT	0	00 P 0	00									X
MAINTENANCE LEVEL: CREW													
TM FGC	ALC TASK CODE	TASK FREQ	MB	HCP	NO SSC	M-H PER SSC	ELAP TIME	SKILL LEVEL	SSC	TRN REC EQP	TRN LCN	RPT PT YYYY	DISP OPT W/P
02	00 AACACAA	.3500	0	N	01	.13	.13(P)	B	76J10	N	N	002	
06	00 CBCACAA	900.0000	0	N	01	.06	.06(M)	B	76J10	N	Y	006	
MAINTENANCE LEVEL: ORG													
02	00 ABOACAA	.3000	0	N	01	.10	.10(P)	B	52C10	J	Y	002	

FIGURE 31. LSA-023 Summary - continued

CORRECTIVE MAINTENANCE REQUIREMENTS SUMMARY

EIAC	LCN NOMENCLATURE	START LCN	ALC	TYPE	STOP LCN	ELAP	SKILL	SSC	TRN	TRN	LCN	RPT	PT	DISP
REFRIG-UNT	REFRIGERATION UNIT	0	00	P	0	TIME	LEVEL	ARMY	REC	EQP	0	YYYY	OPT	W/P
00	00 AGCABAA	.8450	01		.25	.25 (P)	B	76J10	N	N	0			X
00	00 NGCAAAA	3.5470	01		.27	.27 (P)	B	76J10	N	N	0			
00	00 NGCAAAB	3.0410	01		.33	.33 (P)	B	76J10	N	N	0			
00	00 NGCAAAC	5.4050	01		.37	.37 (P)	B	76J10	N	Y	0			
MAINTENANCE LEVEL: CREW														
00	00 HGOAAAA	4.0540	01		.46	.46 (P)	I	52C20	J	Y	0			
00	00 HGOAAAA	4.0540	01		.17	.46 (P)	I	52C10	J	Y	0			
00	00 JGOAAAA	5.4050	01		.33	.33 (P)	I	52C20	J	Y	0			
00	00 NGOAAAA	3.0070	01		.23	.23 (P)	I	52C20	J	Y	0			
00	00 NGOAAAB	2.8010	01		.25	.25 (P)	I	52C20	J	N	0			
00	00 HGOAAAC	5.1050	01		.25	.25 (P)	I	52C20	J	N	0			
MAINTENANCE LEVEL: ORG														

FIGURE 31. LSA-023 Summary - continued

MAINTENANCE PLAN SUMMARY
PART IV RESOURCE REQUIREMENTS

EIAC	LCN NOMENCLATURE	START LCN	ALC	TYPE	STOP LCN	UOC	SERV DES	ICC	SELECTED	RPT	PT	DISP
REFRIG-UNIT	REFRIGERATION UNIT	0	00	P	0	DCY	ARMY	BZQY	YYYY	XXXX	W/P	X

MAINTENANCE LEVEL: CREW

TM	FGC	ALC	LCN NOMENCLATURE	LCN	TASK CODE	TASK IDENTIFICATION	FAC
00	00	00	REFRIGERATION UNIT	0	AGCABAA	INSPECT DAMAGE	N

MAINTENANCE LEVEL: CREW

TM	FGC	ALC	LCN NOMENCLATURE	LCN	TASK CODE	TASK IDENTIFICATION	FAC
00	00	00	REFRIGERATION UNIT	0	NGCAAAA	FAULT LOCATION - UNIT INOPERABLE	N

REQUIREMENTS FOR SUPPORT EQUIPMENT:

ICC	ITEM NAME	QTY/TASK	UM	REFERENCE NUMBER	CAGE
Q	FUEL, REG GASOLINE	16.00	GL	VV-G-1690	44566

MAINTENANCE LEVEL: CREW

TM	FGC	ALC	LCN NOMENCLATURE	LCN	TASK CODE	TASK IDENTIFICATION	FAC
00	00	00	REFRIGERATION UNIT	0	NGCAAB	FAULT LOCATION - INSUFFICIENT COOLING	N

MAINTENANCE LEVEL: CREW

TM	FGC	ALC	LCN NOMENCLATURE	LCN	TASK CODE	TASK IDENTIFICATION	FAC
00	00	00	REFRIGERATION UNIT	0	NGCAAAC	FAULT LOCATION - NOISY OPERATION	N

MAINTENANCE LEVEL: ORG

TM	FGC	ALC	LCN NOMENCLATURE	LCN	TASK CODE	TASK IDENTIFICATION	FAC
00	00	00	REFRIGERATION UNIT	0	HG0AAAA	REPLACE REFRIGERATION UNIT	N

REQUIREMENTS FOR SUPPORT EQUIPMENT:

ICC	ITEM NAME	QTY/TASK	UM	REFERENCE NUMBER	CAGE
Q	CLOTHS	.10	PG	E3727	44565
Q	SHIMS	2.00	EA	E3727	44565
Z	TOOL KIT GEN REFRIG	1.00	EA	SC5180-90-CL-N14	44940
4	SOCKET SET	1.00	EA	B2502	22312

FIGURE 31. LSA-023 Summary - continued

MAINTENANCE PLAN

EIAC LCN NOMENCLATURE START LCN ALC STOP LCN UOC SERV DES DISP OPT
REFRIG UNT DELUXE CARB 00607 02 DCY ALL LCN

SELECTION SUMMARY

MAINTENANCE LEVEL OPTION: ALL

TECHNICAL FACTORS BASIS NUMBER: 1

PART 2 ITEM CATEGORY CODES SELECTED: ALL

PART III ITEM CATEGORY CODES SELECTED: ALL

EQUIPMENT TYPE CODE: SUPPORT EQUIPMENT

REPORT PARTS SELECTED: ALL

FIGURE 32. LSA-024 Summary

MAINTENANCE PLAN

PART I - GENERAL CONSIDERATIONS

REFERENCE NUMBER 142-0431ALCA CAGE 33647 TYPE EQUIP CODE: T123

ITEM DESIGNATOR NSN & RELATED DATA

TM FGC: 0601 SMR CODE: PAOFF PREPARING ACTIVITY MRS

NALC: A1B DLSC SCREEN: 10-05-84 PREPARED BY: FISHER

REVIEWED BY: _____

MAINTENANCE PLAN NUMBER TEST DATE OF SUB/REV/DATE OF REV: 06-06-47/A/04-16-44

APPROVED BY: _____ DATE OF APPROVAL: _____

TITLE: _____

LCN 00607

ALC 02 NARRATIVE

ITEM FUNCTION: DEVICE PRODUCING AN EXPLOSIVE MIXTURE OF GAS AND AIR.

MAINTENANCE CONCEPT: ADJUST AND REPLACE TASKS ACCOMPLISHED BY ORGANIZATIONAL MAINTENANCE. DISASSEMBLE/ASSEMBLE. REPAIR AND SERVICE PERFORMED BY DIRECT SUPPORT MAINTENANCE.

MAINTENANCE PLAN RATIONALE:

FIGURE 32. LSA-024 Summary - continued

MAINTENANCE PLAN
PART II - REPAIR CAPABILITY

REFERENCE NUMBER 142-0431ALCA CAGE 33647
 TYPE EQUIP CODE: TL23
 ITEM DESIGNATOR SMR CODE: PAOFF SMR CODE: PAOFF PREPARING ACTIVITY MRSA
 NALC: ALB
 DLSC SCREEN: 10-05-84 PREPARED BY: FISHER
 REVIEWED BY: _____
 NSN & RELATED DATA
 DATE OF SUB/REV/DATE OF REV: 06-06-47/A/04-16-44
 MAINTENANCE PLAN NUMBER
 TEST
 SERD NUMBER TESTX12345
 APPROVED BY: _____ DATE OF APPROVAL: _____
 TITLE: _____

REPAIRABLE ITEMS
 LCN 00607 ALC REFERENCE NUMBER 02 142-0431ALCA
 CAGE ITEM NAME 44940 CARBURETOR ASSY
 NSN & RELATED DATA 0601
 TM FGC 0601
 IND B
 I/R

TECHNICAL FACTORS
 MAINTENANCE TASK DISTRIBUTION
 O DS GS SRA D CBD CAD
 -- 35 20 -- 00 15 00
 MRR: 1.3323 NSO: 5
 MRF: 00.0000 SAR: 1.00
 RPF: 00.7328 RSR:
 DSR: RRR: .01
 BDSR: 00.1998
 INTERVAL MAINT CYCLE
 P: 1473.4 1680
 T:
 U:

MAINTENANCE SIGNIFICANT CONSUMABLES
 LCN 00607AA ALC REFERENCE NUMBER 02 142-0431ALCA
 CAGE ITEM NAME 44940 VALVE, CARBURETOR
 NSN & RELATED DATA
 TM FGC
 IND
 I/R

FIGURE 32. LSA-024 Summary - continued

MAINTENANCE PLAN

PART III - MAINTENANCE REQUIREMENTS

REFERENCE NUMBER 142-0431ALCA
 ITEM DESIGNATOR
 CAGE 33647
 TM FGC: 0601
 TYPE EQUIP CODE: T123
 SMR CODE: PAOFF
 PREPARING ACTIVITY
 MRSA
 NALC: A1B
 PREPARED BY: FISHER
 DLSC SCREEN: 10-05-84
 REVIEWED BY: _____

MAINTENANCE PLAN NUMBER
 TEST
 DATE OF SUB/REV/DATE OF REV: 06-06-47/A/04-16-44
 SERD NUMBER
 TESTX12345
 APPROVED BY: _____ DATE OF APPROVAL: _____
 TITLE: _____

LCN	REQ NO	ALC	TASK CD	TASK IDENTIFICATION	TSK FREQ	MB	INTERVAL	TM FGC
00607	0001C	02	HGOXGAA	REPLACE CARBURETOR ON ENGINE ASSY	1.1400	O	1473.4	0601

SUPPORT EQUIPMENT REQUIREMENTS

REFERENCE NUMBER	CAGE	ITEM NAME	ICC
S023	41497	SEALANT, GASKET	Q
142-0431	44940	CARBURETOR	X
142-0033	41497	GASKET, KIT	Y
SC5180-90-CL-N14-1234	44940	TOOL KIT GEN REFRIG	Z
B2502	04643	SOCKET SET 3/8 INCH	4
GGG-S-121	04643	SCREWDRIVER	4

LCN	REQ NO	ALC	TASK CD	TASK IDENTIFICATION	TSK FREQ	MB	INTERVAL	TM FGC

FIGURE 32. LSA-024 Summary - continued

PACKAGING REQUIREMENTS DATA

EIAC REFRIG-UNIT	ITEM NAME	START LCN	ALC TYPE	STOP LCN	UOC	DEGREE OF PROT	TAPE OPTION
	REFRIGERATION UNIT 0	00	P		C		NO

CAGE REFERENCE NUMBER	ITEM NAME
10855 AA06BR200	SCREW, HEX HEAD

CARD RES (5 POS)	NSN AND MTL-MGT-CD	UNIT WEIGHT	UNIT SIZE	PKG SPEC	QUP	ICQ	CAGE	REFERENCE NUMBER	SCI
A	5305-00-378-2804	-- 00001	0010 0005 0005	32A0	99	012	024	10855 AA06BR200	4

CARD RES (5 POS)	NSN AND MTL-MGT-CD	HC	QUP	ICQ	MTH	CD	PRES	WRAP	CUSH	CT	UNIT	DOP	INT	UC	SPEC	PK CD
B	5305-00-378-2804	--	012	024	--	0	00	--	00	-	WR	C	11	A	99	Y

UNIT PACK UNIT PACK SIZE UNIT PACK RES OPI SCI
 WEIGHT LEN WID DEP CUBE (5 POS)

----- 0011 0007 0007 0000539 ----- A 4

SUPPLEMENTAL PACKAGING DATA

C ----- 5303-00-378-2804 -- TEST-NARRATIVE--TEST-NARRATIVE--TEST-NARRATIVE--TEST-NARRAT

CARD RES (5 POS)	NSN AND MTL-MGT-CD	CAGE	SPI NUMBER	SPI RES	SPI DATE	CONTAINER	NSN
D	5303-00-378-3804	-- 44940	-----	-	---	90061	-----

APPROVED BY: _____
 APPROVAL DATE: _____

FIGURE 33. LSA-025 Summary

PACKAGING DEVELOPMENTAL DATA

EIAC ITEM NAME START LCN ALC TYPE STOP LCN UOC SOURCE CODE
 REFRIG-UNT REFRIGERATION UNIT 0 00 P 8080 PA
 CAGE REFERENCE NUMBER
 10855 AA06BR200

CAGE REFERENCE NUMBER	NAT STOCK NUMBER	ITEM NAME	UI	UNIT WEIGHT	UNIT SIZE		
					LENGTH	WIDTH	HEIGHT
10855 AA06BR200	5303-00-378-2804	SCREW, CAP HEX HEAD EA	EA	0.1	0.4	0.4	3.5

LCN	ALC	QTY/ASSY	QTY/EI	SMR	USABLE ON CODES	LOT QUANTITY			
						FROM	TO	PKG-CAT	
00201AA	00	0003	000027	PAOZZ	DCY, DCX, DCZ	0.17	000001	000025	C 001 8080
00304AC	00	0006	REF	PAOZZ	DCY, DCZ	0.15	000026	000100	B 001
0030609AQ	00	0002	REF	PAFZZ	DCY, DCZ				
0050201AZ	00	0002	REF	PAOZZ	DCY, DCX, DCZ				

FIGURE 34. LSA-026 Summary

FAILURE/MAINTENANCE RATE SUMMARY
CORRECTIVE MAINTENANCE

EIAC LCN NOMENCLATURE START LCN ALC TYPE STOP LCN UOC SERV DES PROGRAM MB MRR/II
REFRIG-UNIT REFRIGURATION UNIT O 00 P 00607 DCY ARMY 7200 H 2.25

LCN ALC LCN NOMENCLATURE AOR MB SMR CODE MRR MOD WEAROUT LIFE MB
00602 00 PISTON ASSEMBLY 7200 H PAFFF 11111

LCN ALC ITEM NAME REFERENCE NUMBER CAGE SMR CODE MRR MOD
00602 00 PISTON ASSEMBLY RZ4369 34456 PAFFF 11111

MRR I TABLE HG MRR II MRR I CALCULATED MRR II
2.5920 5.832 2.5920 5.832

LCN ALC TASK TABLE CA MB CALCULATED MB
00602 00 HGFAGAA 2.5920 H 2.5920 H

LCN ALC FMI FAIL MODE FAILURE RATE INDUCED MB MTBM NO DEFECT MRR MOD
00602 00 FAAA 1.000 .0006667 (P) H 50000.0 (P) H 30000.0 (P) H 20050

LCN ALC ITEM NAME REFERENCE NUMBER CAGE QTY/TASK UM
0060201 00 PISTON PIN RR423196923 22443 PAFZZ 11111

MRR I TABLE HG MRR II MRR I CALCULATED MRR II
6.7760 15.246 6.7760 15.246

LCN ALC TASK TABLE CA MB CALCULATED MB
00602 00 JGFAGAA 3.3880 H 3.3880 H

LCN ALC REFERENCE NUMBER CAGE QTY/TASK UM
0060201 00 RR423196923 22443 2.00 EA

LCN ALC FMI FAIL MODE FAILURE RATE INDUCED MB MTBM NO DEFECT MRR MOD
00602 00 FAAA 1.000 .0006667 (P) H 50000.0 (P) H 30000.0 (P) H 20050

0060201 00 FAAA 0.400 .0005000 (M) H 50000.0 (P) H 30000.0 (P) H 20050

FIGURE 35. LSA-027 Summary

INDENTURED PARTS LISTINGS

REPAIR PARTS AND SPECIAL TOOLS LIST

EIAC ITEM NAME START LCN ALC TYPE STOP LCN
 REFRIG-UNT COMPRESSOR ASSY 005 00 P

SELECTION SUMMARY

TM CODE: TM2 TM DESIGNATION: TM-5-4110-300-24-P

OPERATIONS/MAINTENANCE LEVELS: CREW (C) YES
 ORGANIZATIONAL (O) YES
 DIRECT SUPPORT/AVIM (F) YES
 GENERAL SUPPORT (H) YES
 SPECIALIZED REPAIR ACTIVITY (L) YES
 DEPOT (D) YES

RANGE ONE	RANGE TWO	RANGE THREE	RANGE FOUR
START FGC 0001	START FGC 9501	START FGC 9501	START FGC
STOP FGC 0001A	STOP FGC 9501	STOP FGC	STOP FGC

CROSS REFERENCE INDEXES: PART NUMBER YES
 NATIONAL STOCK NUMBER YES
 REFERENCE DESIGNATOR YES
 FIGURE/ITEM NUMBER YES

RPSTL FUNCTIONAL GROUP CODE HEADERS

SECTION	TM FUNCT	GROUP SEQ	FUNCTIONAL GROUP CODE	HEADER
2	0001	1	GROUP: 05	
		2	FIG 1 COMPRESSOR ASSEMBLY	
3	9501	1	GROUP: 95	
		2	FIG 27 SPECIAL TOOLS	

FIGURE 36. LSA-030 Summary (Option 1).

(6) TIME: 14:20 DATE: 90/03/02

(5) DESCRIPTION AND USABLE ON CODE (UOC)

(1) (2) (3) (4) (5) (6) (7) (8) (9) (10)

ITEM NO	SMR	CAGE NUMBER	PART	DESCRIPTION AND USABLE ON CODE (UOC)	QTY	FIG NO	FGC	PLCC	NSN	PCCN	PLISN
1	PAOFF	10855	6D23-522	VALVE PLATE ASSY UOC:DCY,FFA,AAB,AAC.....	1	1	0001	Y	A90B10	A101	
2	PAFZZ	41947	A5051	NUT, TUB, COUPLING UOC:DCY,FFA,AAB.....	2	1	0001	Y	A90B10	A102	
3	PAOZZ	31246	ENO748EAA3412378 12-24N	VALVE, SERVICE UOC:DCY,FFA,AAB,FF.....	1	1	0001	Y	A90B10	A103	
4	PAFZZ	44282	123123123	CAP, TUBE UOC:DCY,FFA.....	1	1	0001	Y	A90B10	A104	
5	KFOZZ	11215	6D43-1421	GASKET, VALVE PART OF KIT P/N 142-0033 UOC:DCY.....	2	1	0001	N	A90B10	A105	
6	PAFZZ	25557	6D40-2163	HEAD, COMPRESSOR UOC:DCY,FFA.....	1	1	0001	Y	A90B10	A106	
7	KFOZZ	32145	6D43-1427	GASKET, HEAD PART OF KIT P/N 142-0033 UOC:DCY,AAB.....	1	1	0001	N	A90B10	A107	
8	PAOZZ	10855	MS27183-123	WASHER, FLAT UOC:DCY,FFA.....	2	1	0001	Y	A90B10	A108	
9	PAOZZ	10855	MS18802.35	SCREW, CAP, HEX HD UOC:DCY.....	2	1	0001	Y	A90B10	A109	
10	PAOZZ	10855	MS3880-2.35	NUT, PLAIN, HEX UOC:DCY.....	2	1	0001	Y	A90B10	A110	

FIGURE 36. LSA-030 Summary (Option 1) - continued

(1) (2) (3) (4) (5) (6) TIME: 14:20 DATE: 90/03/01

ITEM SMR CAGE NUMBER PART NUMBER QTY FIG NO FGC PLCC NSN PCCN PLISN

1 PAODD 73785 GA9473512
 DITMCO STATION 27 9501 D Y A90B10 T101
 UOC DCY.....
 BOI 00002 A1
 BOI 00004 B2
 BOI 00003 F3

2 PAOHH 01762 SN517832105
 VOLTMETER, MICROWAVE 27 9501 D Y A90B10 T102
 UOC DCY.....
 BOI 00001-24 1
 BOI 0000225-48 2
 BOI 0000349-100 3

FIGURE 36. LSA-030 Summary (Option 1). - continued

SPECIAL TOOLS LIST

TIME: 14:20 DATE: 90/03/01

CROSS REFERENCE INDEXES

PART NUMBER INDEX

CAGE	PART NUMBER	STOCK NUMBER	FIGURE NO	ITEM NO
41947	A5051	5305-00-225-8507	1	2
31246	EN0748FAA3412378	4820-00-316-2695	1	3
	12-24N			
73785	GA9473512	6680-01-122-8053	27	1
10855	MS18802.35	5315-00-984-3521	1	9
10855	MS27183-123	5315-00-925-8884	1	8
01762	SN517832105	6689-00-734-1394	27	2
44282	123123123	4320-01-345-9801	1	4
44940	GDKIT12-135	4130-00-328-2898	1	KIT
10855	6D23-522	3150-00-976-9943	1	1
25557	6D40-2163	4120-00-285-9801	1	6

NATIONAL STOCK NUMBER INDEX

STOCK NUMBER	FIGURE NO	ITEM NO	STOCK NUMBER	FIGURE NO	ITEM NO
5305-00-225-8507	1	2	5315-00-925-8884	1	8
4120-00-285-9801	1	6	3150-00-976-9943	1	1
4820-00-316-2695	1	3	5315-00-984-3521	1	9
4130-00-328-2898	1	KIT	6680-01-122-8053	27	1
6689-00-734-1394	27	2	4320-01-345-9801	1	4

FIGURE 36. LSA-030 Summary (Option 1). - continued

TIME: 14:20 DATE: 90/03/01

CROSS REFERENCE INDEXES

REFERENCE DESIGNATION INDEX

REFERENCE DESIGNATION	FIGURE NO	ITEM NO
CCHO415192AAAR	1	4
CCHO415192AABA	1	7
CCHO415192AACC	1	3
CCHO415211AA	1	9
CCHO415311AA	1	1
CCHO415331AC-AAO/A128.32/YIL,121 31314	1	6
CCHO41541512	1	2
CCHO419223AV	1	5
CCHO6121223T	1	8

FIGURE AND ITEM NUMBER INDEX

FIGURE NO	ITEM NO	STOCK NUMBER	CAGE	PART NUMBER
1	KIT	4130-00-328-2898	44940	6DKIT12-135
1	1	3150-00-976-9943	10855	6D23-522
1	2	5305-00-225-8507	41947	A5051
1	3	4820-00-316-2695	31246	EN0748EAA3412378
				12-24N
1	4	4320-01-345-9801	44282	123123123
1	6	4120-00-285-9801	25557	6D40-2163
1	8	5315-00-925-8884	10855	MS27183-123
1	9	5315-00-984-3521	10855	MS18802.35
27	1	6680-01-122-8053	73785	GA9473512
27	2	6689-00-734-1394	01762	SN517832105

INDENTURED PARTS LISTINGS

REPAIR PARTS AND SPECIAL TOOLS LIST

EIAC ITEM NAME START LCN ALC TYPE STOP LCN
 REFRIG-UNT COMPRESSOR ASSY 005 00 P

SELECTION SUMMARY

TM CODE: TM2 TM DESIGNATION: TM-5-4110-300-24-P

OPERATIONS/MAINTENANCE LEVELS: CREW (C) YES
 ORGANIZATIONAL (O) YES
 DIRECT SUPPORT/AVIM (F) YES
 GENERAL SUPPORT (H) YES
 SPECIALIZED REPAIR ACTIVITY (L) YES
 DEPOT (D) YES

RANGE ONE	RANGE TWO	RANGE THREE	RANGE FOUR
START FGC 0001	START FGC 9501	START FGC 9501	START FGC
STOP FGC 0001A	STOP FGC 9501	STOP FGC	STOP FGC

CROSS REFERENCE INDEXES: PART NUMBER YES
 NATIONAL STOCK NUMBER YES
 REFERENCE DESIGNATOR YES
 FIGURE/ITEM NUMBER YES

RPSTL FUNCTIONAL GROUP CODE HEADERS

SECTION	TM FUNCT GROUP SEQ	FUNCTIONAL GROUP CODE HEADER
2	0001	1 GROUP: 05
		2 FIG 1 COMPRESSOR ASSEMBLY
3	9501	1 GROUP: 95
		2 FIG 27 SPECIAL TOOLS

FIGURE 36. LSA-030 Summary (Option 2).

SECTION II TM-5-4110-300-24-P

(1) ITEM NO	(2) SMR	(3) CAGE NUMBER	(4) PART NUMBER	(5) DESCRIPTION AND USABLE ON CODE (UOC)	(6) QTY
GROUP: 05					
FIG 1 COMPRESSOR ASSEMBLY					
1	PAOFF	10855	6D23-522	VALVE PLATE ASSY.....	1
2	PAFZZ	41947	A5051	..NUT, TUB, COUPLING.....	2
3	PAOZZ	31246	ENO748EAA3412378 12-24N	..VALVE, SERVICE.....	1
4	PAFZZ	44282	123123123	CAP, TUBE.....	1
UOC:DCY					
5	KFOZZ	11215	6D43-1421	GASKET, VALVE PART OF KIT P/N	2
6	PAFZZ	25557	6D40-2163	142-0033.....	1
7	KFOZZ	32145	6D43-1427	HEAD, COMPRESSOR.....	1
GASKET, HEAD PART OF KIT P/N					
8	PAOZZ	10855	MS27183-123	142-0033.....	1
9	PAOZZ	10855	MS18802.35	WASHER, FLAT.....	2
KIT	PAOZZ	44940	6DKIT12-135	SCREW, CAP, HEX HD.....	2
KIT, GASKET.....					
GASKET, VALVE (2) 1-5					
GASKET, HEAD (1) 1-7					

END OF FIGURE

FIGURE 36. ISA-030 Summary (Option 2). - continued

SECTION III TM-5-4110-300-24-P

(1) ITEM NO	(2) SMR	(3) CAGE NUMBER	(4) PART NUMBER	(5) DESCRIPTION AND USABLE ON CODE (UOC)	(6) QTY
1	PAODD	73785	GA9473512	DITMCO STATION UOC:DCY BOI:2 PER LETTERED COMPANY BOI:4 PER BN HQ BOI:3 BY NUMBERED BTRY/COMPANY AND SIMILAR HQ PERFORMING ORG MAINT FOR OTHER UNITS VOLTMETER, MICROWAVE UOC:DCY	
2	PAOHH	01762	SN517832105	GROUP: 95 FIG 27 SPECIAL TOOLS BOI:1 PER 1-24 END ITEMS BOI:2 PER 25-48 END ITEMS BOI:3 PER 49-100 END ITEMS	

END OF FIGURE

FIGURE 36. LSA-030 Summary (Option 2). - continued

SECTION IV

TM-5-4110-300-24-P

CROSS REFERENCE INDEXES

PART NUMBER INDEX

CAGE	PART NUMBER	STOCK NUMBER	FIGURE NO	ITEM NO
41947	A5051	5305-00-225-8507	1	2
31246	EN0748FAA3412378	4820-00-316-2695	1	3
	12-24N			
73785	GA9473512	6680-01-122-8053	27	1
10855	MS18802.35	5315-00-984-3521	1	9
10855	MS27183-123	5315-00-925-8884	1	8
01762	SN517832105	6689-00-734-1394	27	2
44282	123123123	4320-01-345-9801	1	4
44940	GDKIT12-135	4130-00-328-2898	1	KIT
10855	6D23-522	3150-00-976-9943	1	1
25557	6D40-2163	4120-00-285-9801	1	6

NATIONAL STOCK NUMBER INDEX

STOCK NUMBER	FIGURE NO	ITEM NO	STOCK NUMBER	FIGURE NO	ITEM NO
5305-00-225-8507	1	2	5315-00-925-8884	1	8
4120-00-285-9801	1	6	3150-00-976-9943	1	1
4820-00-316-2695	1	3	5315-00-984-3521	1	9
4130-00-328-2898	1	KIT	6680-01-122-8053	27	1
6689-00-734-1394	27	2	4320-01-345-9801	1	4

FIGURE 36. ISA-030 Summary (Option 2). - continued

SECTION IV

TM-5-4110-300-24-P

CROSS REFERENCE INDEXES

REFERENCE DESIGNATION INDEX

REFERENCE DESIGNATION	FIGURE NO	ITEM NO
CCHO415192AAAR	1	4
CCHO415192AABA	1	7
CCHO415192AACC	1	3
CCHO415211AA	1	9
CCHO415311AA	1	1
CCHO415331AC-AAO/A128.32/YIL,121 31314	1	6
CCHO41541512	1	2
CCHO419223AV	1	5
CCHO6121223T	1	8

FIGURE AND ITEM NUMBER INDEX

FIGURE NO	ITEM NO	STOCK NUMBER	CAGE	PART NUMBER
1	KIT	4130-00-328-2898	44940	6DKIT12-135
1	1	3150-00-976-9943	10855	6D23-522
1	2	5305-00-225-8507	41947	A5051
1	3	4820-00-316-2695	31246	EN0748EAA3412378 12-24N
1	4	4320-01-345-9801	44282	123123123
1	6	4120-00-285-9801	25557	6D40-2163
1	8	5315-00-925-8884	10855	MS27183-123
1	9	5315-00-984-3521	10855	MS18802.35
27	1	6680-01-122-8053	73785	GA9473512
27	2	6689-00-734-1394	01762	SN517832105

FIGURE 36. ISA-030 Summary (Option 2). - continued

INDENTURED PARTS LISTING
ILLUSTRATED PARTS BREAKDOWN

EIAC ITEM NAME START LCN ALC TYPE STOP LCN
REFRIG-UNT COMPRESSOR ASSY 005 00 P

SELECTION SUMMARY

TM CODE: TM2 TM DESIGNATION: TM-5-4110-300-24-P

OPERATIONS/MAINTENANCE LEVELS: ORGANIZATIONAL/ON-EQUIPMENT (O) YES
INTERMEDIATE/OFF-EQUIPMENT (F) YES
DEPOT (D) YES

SECTION SELECTION: MAINTENANCE PARTS LIST YES
NUMERICAL INDEX YES
REFERENCE DESIGNATION YES

FIGURE 36. LSA-030 Summary (Option 3).

II. MAINTENANCE PARTS LIST TM-5-4110-300-24-P

FIG NO	ITEM NO	PART NUMBER	CAGE	1234567 DESCRIPTION	QTY PER ASSY	UOC	SMR
1	1	6D23-522	10855	VALVE PLATE ASSY.....	1	DCY	PAOFF
1	2	A5051	41947	..NUT, TUB, COUPLING.....	2	DCY	PAFZZ
1	3	ENO748EAA3412378 12-24N	31246	..VALVE, SERVICE.....	1	DCY	PAOZZ
1	4	123123123	44282	CAP, TUBE.....	1	DCY	PAFZZ
1	5	6D43-1421	11215	GASKET, VALVE PART OF KIT P/N 142-0033.....	2	DCY	KFOZZ
1	6	6D40-2163	25557	HEAD, COMPRESSOR.....	1	DCY	PAFZZ
1	7	6D43-1427	32145	GASKET, HEAD PART OF KIT P/N 142-0033.....	1	DCY	KFOZZ
1	8	MS27183-123	10855	WASHER, FLAT.....	2	DCY	PAOZZ
1	9	MS18802.35	10855	SCREW, CAP, HEX HD.....	2	DCY	PAOZZ
	KIT	6DKIT12-135	44940	KIT, GASKET.....	V	DCY	PAOZZ
				GASKET, VALVE (2) 1-5			
				GASKET, HEAD (1) 1-7			

FIGURE 36. ISA-030 Summary (Option 3). - continued

III. NUMERICAL INDEX

TM-5-4110-300-24-P

PART NUMBER	FIGURE		ITEM		QTY PER		SMR CODES
	NO	NO	NO	NO	END	ITEM	
6D23-522	1	2	1	2	1	1	PAOFF
A5051	1	6	1	6	2	2	PAFZZ
ENO748EAA3412378	1	3	1	3	1	1	PAOZZ
12-24N							
123123123	27	2	2	2	1	1	PAFZZ

FIGURE 36. LSA-030 Summary (Option 3). - continued

IV. REFERENCE DESIGNATION

TM-5-4110-300-24-P

REFERENCE DESIGNATION	FIGURE NO	ITEM NO	PART NUMBER
CCHO415192AAAR	1	4	6D23-522
CCHO415192AABA	1	7	A5051
CCHO415192AACC	1	3	ENO748EAA3412378 12-24N
CCHO415211AA	1	9	123123123
CCHO415311AA	1	1	6D43-1421
CCHO415331AC-AAO/A128.32/YIL, 121 31314	1	6	231423
CCHO41541512	1	2	6D40-2163
CCHO419223AV	1	5	6D43-1427
CCHO6121223T	1	8	MS27183-123

FIGURE 36. LSA-030 Summary (Option 3). - continued

INDENTURED PARTS LIST
STOCKAGE LIST TYPE FOUR

SELECTION SUMMARY

ETAC	ITEM NAME	START LCN	ALC TYPE	STOP LCN	STOCK LIST NUMBER
REFRIG-UNT	REFRIGERATION UNIT	0	00	P	SL-3-88643E

UOC(S) : DCY, DCZ, ABC

FIGURE 36. LSA-030 Summary (Option 4).

SL-4-88647E

MARINE CORPS STOCK LIST
 PART I ITEM IDENTIFICATION LISTING

1	2	3	4	5	6	7	8	9	10	11		
ITEM NO.	MODEL	NATIONAL STOCK NUMBER	REF DESIG FIG-KEY	I N D	ITEM IDENTIFICATION	UM	QUANTITY PER APPL	SMR CODE	S REPL I FACTOR	CAGE REFERENCE NUMBER	TMC	FIG NO.
1	DCY	3150-00-976-9943	001-0001	C	VALVE PLATE ASSY	EA	1	1 PAFZZ	0.121	10855 6D23-522	TM2	2
2	DCY	5305-00-225-8507	001-0002	D	NUT, TUB, COUPLING	EA	2	12 PAFZZ	0.165	41947 A5051	TM2	2
3	DCY	4820-00-316-2695	001-0003	D	VALVE, SERVICE	EA	1	2 PAFZZ	0.123	31246 EN0748EAA3412378 12-24N	TM2	2
4	DCY	4320-01-345-9801	001-0004	C	CAP, TUBE	EA	1	1 PAFZZ	0.874	44282 123123123	TM2	2
5	DCY	001-0005	001-0005	C	GASKET, VALVE	EA	2	2 KFOZZ	1.222	11215 6D43-1421	TM2	2
6	DCY	4120-00-285-9801	001-0006	C	HEAD, COMPRESSOR	EA	1	1 PAFZZ	0.367	25557 6D40-2163	TM2	2
7	DCY	001-0007	001-0007	C	GASKET, HEAD	EA	1	1 KFOZZ	1.222	32145 6D43-1427	TM2	2
8	DCY	5315-00-925-8884	001-0008	C	WASHER, FLAT	EA	2	12 PAFZZ	0.321	10855 MS27183-123	TM2	2
9	DCY	5315-00-984-3521	001-0009	C	SCREW, CAP, HEX HD	EA	2	12 PAFZZ	0.321	10855 MS18802.35	TM2	2

FIGURE 36. LSA-030 Summary (Option 4). - continued

DEFENSE LOGISTICS SERVICES CENTER (DLSC) SUBMITTALS
PROVISIONING SCREENING

EIAC	ITEM NAME	START LCN	ALC TYPE	STOP LCN	TYPE SCREEN	STAT IND	PRI IND	JULIAN	DIC	DSRC	DLSC
REFRIG-UNIT	REFRIGERATION UNIT 0	0	P	00	00	00	00	A90B10			
ACTIVITY	DESTINATION	OUT DATA	SGL/MULT	SOURCE	ARN SEL	TYPE SCREEN	STAT IND	PRI IND	JULIAN	DIC	DSRC
CODE	REQ CODE	REQ CODE	OUT CODE	CODE	CODE	CODE	CODE	CODE	DATE	SUPPRESS	SUPPRESS
MU	XMDSE	9910	4	PA	YES	F	A	4	0060	YES	A, B, C
											YES

ERROR CODE

- 1 - MISSING PCCN/PLISN
- 2 - MORE THAN 24 ADDITIONAL REFERENCE NUMBER/CAGES FOR ONE REFERENCE NUMBER.
- 3 - SOURCE CODE (SMR) NOT RECORDED.
- 4 - DUPLICATE REFERENCE NUMBER/ADDITIONAL REFERENCE NUMBER AND CAGES (F & S TYPE SCREEN).
- 5 - MISSING RNCC/RNVC FOR P TYPE SCREEN.

PART ONE SUBMITTER'S CONTROL NUMBER - LCN CROSS REFERENCE LIST

SUBMITTER CONTROL	REFERENCE NUMBER/ARN	CAGE	RNCC	RNVC	LCN	ALC	SMR	ERROR CODE(S)
0060AA90B10AACG	A123161142F-110	44940	5	9	005	00	PAOFF	
	1246-123	11267	5	2		00		
	41232/87AT	88714	3	2		00		
0060AA90B10AAEF	ER191923C-192	33251	3	2	0030201AA	00	PAOZZ	
	1121987/23-N	23231	5	9		00		
0060AA90B10AALG	C1219036-23	76743	3	2	00210AA	00	PAHZZ	
0060AA90B10AAM3	A18918234-45	34123	5	9	0010208AZ	00	PAFZZ	
	6565431	22178	5	2		00		
	ER12156/GH	33156	3	2		00		
	C120134	44569	5	9		00		

FIGURE 37. LSA-032 Summary

DEFENSE LOGISTICS SERVICES CENTER (DLSC) SUBMITTALS
PROVISIONING SCREENING

PART TWO

CARD IMAGE DLSC SCREENING

CARD COL	DESCRIPTION	LSR	CARD COL	DESCRIPTION	TYPE SCREENING CODE	F
01-03	DOCUMENT IDENTIFIER CODE		32	TYPE SCREENING CODE		
04-06	PACKAGE SEQUENCE NUMBER		33-36	OUTPUT DATA REQ		9910
07	PRIORITY INDICATOR	4	37	STATISTICAL INDICATOR		A
08-09	ACTIVITY CODE	MU	38	SINGLE/MULTIPLE OUTPUT		4
10-26	SUBMITTER CONTROL NUMBER		39	RNFC (LEFT BLANK)		
10-13	JULIAN DATE	0060	40	DIDS SEGMENT CODE		2
14	SERVICE DESIGNATOR CODE	A	41	RNCC (P TYPE SCREEN)		
15-25	PCCN-PLISN		42	RNVC (P TYPE SCREEN)		
26	BLANK		43-47	CAGE		
27-31	DESTINATION CODE	XMDSE	48-79	REFERENCE NUMBER/ARN		
			80	CONTINUATION INDICATOR		1
.....0.....0.....0.....0.....0.....0.....0
1	2	3	4	5	6	7
.....0.....0.....0.....0.....0.....0.....0
LSRA014MU0060AA90B10AAAG	XMDSEF9910A4	2	44940A123161142F-110			1
LSRA024MU0060AA90B10AAAG	XMDSEF9910A4	2	112671246-123			1
LSRZ034MU0060AA90B10AAAG	XMDSEF9910A4	2	8871441232/87AT			1
LSRA014MU0060AA90B10AAEF	XMDSEF9910A4	2	33251ER191923C-192			1
LSRZ024MU0060AA90B10AAEF	XMDSEF9910A4	2	23231121987/23-N			1
LSRA014MU0060AA90B10AALG	XMDSEF9910A4	2	76743C1219036-23			1
LSRA014MU0060AA90B10AAM3	XMDSEF9910A4	2	34123A18918234-45			1
LSRA024MU0060AA90B10AAM3	XMDSEF9910A4	2	221786565431			1
LSRA034MU0060AA90B10AAM3	XMDSEF9910A4	2	33156ER12156/GH			1
LSRZ044MU0060AA90B10AAM3	XMDSEF9910A4	2	44569C12034			1

TOTAL 80-CARD COLUMN RECORDS TO DLSC: 10

FIGURE 37. LSA-032 Summary - continued

PREVENTIVE MAINTENANCE CHECKS AND SERVICES

EIAC LCN NOMENCLATURE START LCN ALC TYPE STOP LCN UOC SERV DES TM CODE TM NUMBER
 REFRIG-UNT REFRIGERATION UNIT 0 00 P CHECK/OIL/LEVEL/UP TO FULL MARK ON DIPSTICK VISUALLY INSPECT ENGINE DRIVE BELTS FOR FRAYED OR BELT MISSING OR BROKEN
 ARMY TM7 TM 5-4110-296-12

ITEM NO. INTERVAL ITEMS TO CHECK/SERVICE PROCEDURE NOT FULLY MISSION CAPABLE IF:

0001 BEFORE REFRIGERATION UNIT REFRIGERATION UNIT A. CHECK FOR EVIDENCE OF LEAKAGE (OIL, FUEL, CLASS III LEAKAGE IS EVIDENT (NO HYDRAULIC FLUID OR COOLANT) ON OR UNDER THE UNIT. FUEL LEAKAGE IS ALLOWED)
 B. CHECK COOLANT PRESSURE. ADD FREON TO CLASS II LEAKAGE IS EVIDENT APPROXIMATELY 20-22 PSI.
 C. VISUALLY INSPECT FOR LOOSE, MISSING OR DAMAGED PARTS.

0002 BEFORE ENGINE CHECK OIL LEVEL. ADD OIL UP TO FULL MARK ON DIPSTICK

0003 BEFORE BELTS VISUALLY INSPECT ENGINE DRIVE BELTS FOR FRAYED OR BELT MISSING OR BROKEN DETERIORATED CONDITION.

0004 DURING DOOR CHECK FOR PROPER SEAL AND VACUUM. DOOR DOES NOT REMAIN CLOSED

0005 WEEKLY FUEL FILTER DRAIN WATER AND SEDIMENT.

0006 300 HOURS ENGINE DRAIN ENGINE OIL. REFILL CRANKCASE PER LO5-4110-296-12

FIGURE 38. LSA-033 Summary

PROVISIONING REQUIREMENTS

PCPN PIIN/SPIIN NOMENCLATURE OF PRIME SUBMITTER SUBMITTAL MULTI-CONFIG FULL EFFECTIVITY
 MODEL OR TYPE NUMBER CONTROL DATA CAGE CONTROL NO DATE UOCS ASSIGNED UOC SUPPRESS
 A90B10 DAAK-89-1234AALQ123 AN/REF-143 PL-13882B 44940 00001 900301 YES NO

SYSTEM/END ITEM USABLE ON CODES SELECTED: DCY, DCX, DCZ

MULTI-CONFIGURATION UOCS ASSIGNED:

DCY: DCY DCX: DCZ: DCX AND DCY: A DCX AND DCZ: B DCY, DCX, AND DCZ: (BLANK)

FIRST NUMBER SECOND NUMBER THIRD NUMBER FOURTH NUMBER FIFTH NUMBER SIXTH NUMBER
 CHANGE AUTHORITY NUMBERS

FIRST RANGE SECOND RANGE THIRD RANGE FOURTH RANGE FIFTH RANGE
 START-PLISN STOP-PLISN START-PLISN STOP-PLISN START-PLISN STOP-PLISN START-PLISN STOP-PLISN

A121 A125 F121 F125

TYPE LIST(S) OUTPUT MODE PROVISIONING BASELINED QPEI CALCULATED OVERHAUL PLISNS PART II PART III
 PROVISIONING PARTS LIST TAPE AND REPORT YES (INITIAL) YES (OPTION 1) NO STANDARD OPTION 1
 WITH HEADERS

PLISN TOTALS FOR PCPN A90B10

EXTRACTED FROM NOT SELECTED EXTRACTED FROM ADDED TO DELETED FROM NEW PROVISIONING
 H DATA TABLES PROV BASELINE PROV BASELINE PROV BASELINE PROV BASELINE BASELINE

10 8 0 2 0 0 2

LSA-036 PLISN CARD RECORD TOTALS

	A	B	C	D	E	F	G	H	J	K	M
ADDED (TOCC = SPACE)	8	2	2	4	2	0	0	2	6	4	0
MODIFIED (TOCC = L, M, Q)	0	0	0	0	0	0	0	0	0	0	0
DELETED (TOCC = D, G)	0	0	0	0	0	0	0	0	0	0	0

FIGURE 39. LSA-036 Summary

PROVISIONING REQUIREMENTS

PART I

LISTING FOR PCCN: A90B10 AND MODEL: ANREF-143

```

.....1.....2.....3.....4.....5.....6.....7.....8
A90B10DAAK-89-1234AALQ123AN/REF-143      PL-13882B 4494000001900301
A90B10A123 C44940142-0001                13 LWIDGET, INTERCONNECO 01A
A90B10A123 223234321-0098213             C3                                02A
A90B10A123 4423114321-0987              D3                                03A
A90B10A123 5523ARN-01234                53                                04A
A90B10A123 5240010987432                EA000000995EA0000099500001001PAOZZ A08 01B
A90B10A123 A003 N02100020006000011100000221111W REFERENCE-DESIGNATION-W1 Y01C
A90B10A123 A REFERENCE-DESIGNATION-W1 RA AA001 01D
A90B10A123 EXTRA-LONG-REFERENCE-DESIGNATIONAR 02D
A90B10A123 -FOR-W2 B 03D
A90B10A123 100 EC ZY01E
A90B10A123 00202 APPROVED AT LSAR REVIEW 9/12/88 01H
A90B10A123 TMC 4 12 2001002 00001 A100008 C2 01J
A90B10A123 TMC 4 12 3--84 3 02J
A90B10A123 TMC 5 14 2001002A 00001 A100008 C2 03J
A90B10A123 TMC 5 14 3--84 3 04J
A90B10A123 TMC 4 12TING DEVICE, BRASS 01K
A90B10A123 TMC 5 14TING DEVICE, BRASS SEE FIGURE 4 F02K
A90B10A123 TMC 5 14OR INTERFACE SWITCH CONNECTION TO WIDGET HOLDER. 03K
A90B10F122 D44940142-0001 13 LWIDGET, INTERCONNECO 01A
A90B10F122 223234321-0098213 C3 02A
A90B10F122 4423114321-0987 D3 03A
A90B10F122 5523ARN-01234 53 04A
A90B10F122 5240010987432 EA000000995EA0000099500001001PAFZZ A08 01B
A90B10F122 F011 N0110001REF 0000012300000231AAAAW A123 Y01C
A90B10F122 B F01REFERENCE-DESIGNATION-W1 RA AA001 01D
A90B10F122 100 EC Z 01E
A90B10F122 0150103 01H
A90B10F122 TMC 28 10 2 01501 00001 A100008 C2 01J
A90B10F122 TMC 28 10 3--84 3 02J
A90B10F122 TMC 28 10TING DEVICE, BRASS 01K
.....1.....2.....3.....4.....5.....6.....7.....8

```

TOTAL 80 CARD COLUMN RECORDS ON LSA-036 (INCLUDING HEADER): 31

FIGURE 39. LSA-036 Summary - continued

PROVISIONING REQUIREMENTS

TO IND REFERENCE NUMBER RN RN DA PP E S SL CS CF
 PCCN PLISN CC CD CAGE ADDITIONAL REFERENCE NUMBERS CC VC C SL C ITEM NAME L AC N I
 A90B10 A123 C 44940 142-0001 1 3 - - 1 WIDGET, INTERCONNEC 0 -- 01 A
 22323 4321-0098213 C 3 02 A

TO NSN AND RELATED DATA UI DM PL HC PS PM ADP CS CF
 CC PRE FSC- NIIN----- SUFF UM UM PRICE UI UI PRICE CONV QUP SMR IIL T I PC IC EC N I
 --- 5240 010987432 ---- EA 0000000995 00001 001 PAOZZ A 08 - - - - 01 B

TO NHA NHA TOTAL SAME AS PRIOR CS CF
 CC PLISN IND ORR QPA QPEI MRR-I MRR-II MRR MOD REC QTY PLISN MAOT MAC NRTS LRU N I
 A003 N 021 0002 00006 00000111 0000022 11111W ----- - - - - Y 01 C

TO REFERENCE DESIGNATION RD RD SM PL SM AI AIC RMS RISS RTLL CS CF
 CC UOC REFERENCE DESIGNATION OC C CC CC IC C QTY MRU SL BUY QTY RSR N I

A REFERENCE-DESIGNATION-W1 - R A - - AA 001 --- - - - - 01 D

TO MAINT TASK DISTRIB REPAIR CYCLE TIME--CON REPLACEMENT TASK DIST DES REWORK PT CT AM AM IM RI CS CF
 CC O F H SRA D CB CA O F H SRA D TAT O F H SRA D ONE TWO IC C SC C P N I
 --- - - - - - - - - - - - - - - - 100 ----- EC - - Z Y 01 E

TO CHANGE AUTHORITY SER NUMBER EFFECTIVITY REP/SUP R/S QUANTITY QUANTITY CS CF
 CC NUMBER IC FROM TO TIC PLISN IND SHIPPED PROCURED DCN-UOC N I
 CHG000123 OW ----- 03 AABV R 000333 000444 ---,--- 01 F

TO CHANGE AUTHORITY PRORATED PROPRATED QUANTITY QUANTITY CS CF
 CC NUMBER ELIN QUANTITY ELIN QUANTITY N I
 CHG000123 ELINBB 000400 01 G

TO ALC REMARKS CS CF
 CC LCN ALC REMARKS N I
 00202 00 APPROVED AT LSAR REVIEW 9/12/88 01 H

TO TM FIG ITEM TM QTY WUC/ --BASIS OF ISSUE-- C ITEM NAME CS CF
 CC CODE NO NO CHG IND FIG TM-FGC QTY-A EI LV CTR QTY-A EI LV CTR C CODE N I
 TMC 4 12 - 2 001 002 00001 A 1 00008 C 2 - 77777 01 J

TO TM FIG ITEM CS CF
 CC CODE NO NO PROVISIONING NOMENCLATURE N I
 TMC 4 12 TING DEVICE, BRASS SEE FIGURE 4 FOR INTERFACE SWITCH 01 K

FIGURE 39. LSA-036 Summary - continued

PROVISIONING REQUIREMENTS

STANDARD EDIT REPORT FOR PCCN A90B10

PART II

PLISN	REFERENCE NUMBER	CAGE	LCN	ALC	MESSAGE
A121	14109-23L	44940	002	00	PLISN DISQUALIFIED, NO MATCH ON UOC
A122	12890A-098/32	33125	00201	00	PLISN DISQUALIFIED, NO MATCH ON PTD SELECT
A123	142-0001	44940	00202	00	PLISN RETAINED ON LSA-036 QPEI NOT CALCULATED, NO TOPDOWN BREAKDOWN
A124	1829180/90	89104	00203	00	PLISN DISQUALIFIED, NO MATCH ON UOC
A125	21290/78-1	21289	00204	00	PLISN DISQUALIFIED, NO MATCH ON UOC
F120	AER-01290	45346	0150101	00	PLISN DISQUALIFIED, NO MATCH ON PTD SELECT
F121	5E23	10990	0150102	00	PLISN DISQUALIFIED, NO MATCH ON PTD SELECT
F122	142-0001	44940	0150103	00	PLISN RETAINED ON LSA-036 QPEI NOT CALCULATED, NO TOPDOWN BREAKDOWN
F123	A99-098TY	10990	0150104	00	PLISN DISQUALIFIED, NO MATCH ON PTD SELECT
F124	89-19092/18965RK 7-PQ	65903	0150104	01	PLISN DISQUALIFIED, NO MATCH ON PTD SELECT
F125	231-IU	55901	0150105	00	PLISN DISQUALIFIED, NO MATCH ON PTD SELECT

FIGURE 39. LSA-036 Summary - continued

PROVISIONING REQUIREMENTS

OPTION 1, ARMY EDIT REPORT FOR PCCN A90B10

PART III

EACH EDIT NUMBER (EDIT NO) IS SEPARATELY SELECTABLE BY THE REQUIRING AUTHORITY.

EDIT NO	EDIT	ERRORS	SELECTED	ASSOCIATED ERROR MESSAGES
1	ITEM NAME	0002	YES	010
2	UNIT OF MEASURE (UM) AND UM PRICE	0002	YES	020
3	USABLE ON CODE (UOC)	0000	YES	030
4	INDENTURE CODE (IND CD)		NO	040, 390
5	ADDITIONAL REFERENCE NUMBER (ARN)		NO	050
6	ESSENTIALITY CODE (EC) OPTIONS A OR B	0001	OPTION A	060
7	SHELF LIFE (SL)		NO	070
8	NATIONAL STOCK NUMBER (NSN)		NO	080
9	UNIT OF ISSUE (UI) AND UI PRICE		NO	090
10	QUANTITY PER UNIT PACK		NO	100
11	SOURCE MAINTENANCE AND RECOVERABILITY (SMR) CODE	0006	OPTION B	
	OPTION A			110
	OPTION B			120, 130, 140, 150, 170, 180, 190, 200
	OPTION C			210, 220
12	DEMILITARIZATION CODE (DEMIL)	0000	YES	120, 130, 140, 160, 170, 180, 190, 200
13	PRODUCTION LEAD TIME (PLT)	0000	YES	210, 220
15	PHYSICAL SECURITY/PILFERAGE CODE (PS/PC)		NO	240
16	NEXT HIGHER ASSEMBLY (NHA) PLISN		NO	250
17	QUANTITY PER ASSEMBLY (QPA)		NO	260
18	MAINTENANCE REPLACEMENT RATES (MRR)		NO	270
19	REFERENCE DESIGNATION CODE (RDC)		NO	280
20	ALLOWANCE ITEM CODE (AIC)		NO	290
21	PLISN AND NHA PLISN		NO	300
22	ASTERISK INDENTURE CODE AND NHA PLISN		NO	310
23	ASSEMBLED ITEMS AND PARTS AND SMR		NO	320
24	SMR ASSEMBLY AND PARTS		NO	330, 340
25	ITEM AND NHA ITEM INDENTURE CODE		NO	350
26	UM PRICE OF ITEM AND NHA		NO	360
27	OVERHAUL REPLACEMENT RATES		NO	370
29	INTERCHANGEABILITY CODE (INTCH CD) AND R/S PLISN		NO	380
				400

FIGURE 39. LSA-036 Summary - continued

PART III PROVISIONING REQUIREMENTS
OPTION 1, ARMY EDIT REPORT FOR PCCN A90B10

NOTE: DATA FIELDS AFFECTED BY THE EDIT ARE DEPICTED BY TABLE CODE.DATA ELEMENT CODE FOLLOWING THE EDIT MESSAGE.

- * 010 MISSING ITEM NAME * HA.ITNAMEHA
- * 020 MISSING UM/UM PRICE * HA.UNITMSHA, HE.UMPRICHD, HE.PROUPPHE
- * 030 UOC NOT 3 POSITIONS * HO.UOCSEIXC
- * 040 INDENTURE CODE MISSING * HG.INDCODHG
- * 050 RNCC MISSING, MULTIPLE D & C/7 * HB.ADRNCCHB * ADDITIONAL REFERENCE NUMBERS (ARN) MUST EACH HAVE AN RNCC. IN ADDITION NO MORE THAN ONE DRAWING AND ONE SPECIFICATION NUMBER DESIGNATED BY D AND C OR 7 CAN BE INCLUDED IN ARNS FOR A REFERENCE NUMBER/CAGE COMBINATION.
- * 060 ESSENTIALITY CODE MISSING * HG.ESSCODHG * OPTION A OF ESSENTIALITY CODE (EC) EDIT REQUIRES THAT EC BE ENTERED FOR ALL PLISNS.
OPTION B REQUIRES EC ON RECORDS WITH SMR SOURCE CODE OF PA, PC OR PG.
- * 070 SHELF LIFE MISSING * HA.SHLIFEHA
- * 080 NSN NOT 13 POSITIONS, FIXED * HA.FSCSNHA, HA.NIINSNHA * FSC AND NIIN MUST EITHER BOTH BE BLANK OR HAVE ENTRIES.
- * 090 MISSING UI/UI PRICE & UI CONVERSION FAC * HD.UIPRICHD, HD.PROUPPHD * APPLICABLE ONLY AGAINST "P" SOURCE CODED ITEMS.
- * 100 MISSING QUANTITY PER UNIT PACK * HF.DEGPROHF, HF.QTYUPKHF
- * 110 SMR NOT BLANK (OPTION A) * HG.SMRCODHG
- * 120 SMR OTHER THAN ARMY ALLOWED CODES * HG.SMRCODHG * DATA EDITS FOR OPTIONS B AND C REQUIRE SPECIFIC SUBFIELD EDIT VARIATIONS FROM AR 700-82, JOINT REGULATION GOVERNING USE AND APPLICATION OF SOURCE MAINTENANCE AND RECOVERABILITY CODES, WHICH ARE ESTABLISHED IN THE BASIC EDITS FOR SMR.
 - A. SOURCE CODE (POSITIONS 1 AND 2). CODES MG AND AG ARE NOT ALLOWED. IN ADDITION TO THE CODES LISTED IN AR 700-82, CODE XD IS PERMITTED.
 - B. MAINTENANCE REMOVE (POSITION 3). CODES ALLOWED ARE C, O, F, H, AND D. CODES 2 THROUGH 6 AND G ARE NOT ALLOWED.
 - C. MAINTENANCE REPAIR (POSITION 4). CODES ALLOWED ARE O, F, H, D, L, Z, AND B. CODE G IS NOT ALLOWED.
 - D. RECOVERABILITY CODE (POSITION 5). CODES ALLOWED ARE O, F, H, D, L, Z AND A. CODE G IS NOT ALLOWED.
- * 130 MAINT LEVEL CODES NOT COMPATIBLE (SMR-3/4) * HG.SMRCODHG * THE FOLLOWING COMBINATIONS OF MAINTENANCE (REMOVE) 3D POSITION AND MAINTENANCE (REPAIR) 4TH POSITION OF THE SMR ARE INVALID: DO, DF, DH, HO, HF, AND FO.
- * 140 SMR-3 MUST BE D WHEN SOURCE CODE IS KD * HG.SMRCODHG
- * 150 MAINT/RECOV NOT EQUAL (OPTION B) * HG.SMRCODHG * UNDER SMR EDIT OPTION B, THE SMR-4 AND SMR-5 MUST BE EQUAL; OR SMR-4 MUST BE B; OR SMR-5 MSUT BE A.
- * 160 MAINT/RECOV NOT COMPATIBLE (OPT C) * HG.SMRCODHG * USING SMR EDIT OPTION C, THE FOLLOWING COMBINATIONS OF SMR-4 AND SMR-5 ARE PERMITTED: B-, -A, OO, OF, OH, OL, OD, FF, FH, FL, FD, HH, HL, HD, DD, DL, AND ZZ.

FIGURE 39. LSA-036 Summary - continued

PART III
OPTION 1, ARMY EDIT REPORT FOR PCCN A90B10
PROVISIONING REQUIREMENTS

* 170 MTD NOT COMPATIBLE WITH SMR (SMR3/4) * HG.SMRCODHG, HG.OMTDOOHG, HG.FWMTDFPHG, HG.HMTDHHHG, HG.LMTDLLHG, HG.DMTDDDDHG, HG.CBDMTDGHG, HG.CADMTDGHG * AN EDIT IS PERFORMED BETWEEN SMR AND MAINTENANCE TASK DISTRIBUTION (MTD). MTD IS A MANDATORY ENTRY FOR ALL PA, PC, OR PG SOURCE CODED ITEMS WHEN SMR-4 IS NOT Z OR B. OTHERWISE, MTD SHOULD BE BLANK.

A. IF SMR-3 EQUALS O AND SMR-4 IS:

- O, THEN MTD-O AND CBD MUST EQUAL 100 PERCENT.
- F, THEN MTD-O, MTD-F, AND CBD MUST EQUAL 100 PERCENT AND MTD-F CANNOT BE BLANK.
- H, THEN MTD-O, MTD-F, MTD-H, MTD-L, AND CBD MUST EQUAL 100 PERCENT AND MTD-H/L CANNOT BE ZERO.
- D, THEN MTD-O, MTD-F, MTD-H, MTD-L, MTD-D AND CAD MUST EQUAL 100 PERCENT AND MTD-D CANNOT BE ZERO.

B. IF SMR-3 EQUALS F AND SMR-4 IS:

- F, THEN MTD-F, AND CBD MUST EQUAL 100 PERCENT AND MTD-F CANNOT BE BLANK.
- H, THEN MTD-F, MTD-H, MTD-L, AND CBD MUST EQUAL 100 PERCENT AND MTD-H/L CANNOT BE ZERO.
- D, THEN MTD-F, MTD-H, MTD-L, MTD-D AND CAD MUST EQUAL 100 PERCENT AND MTD-D CANNOT BE ZERO.

C. IF SMR-3 EQUALS H AND SMR-4 IS:

- H, THEN MTD-H, MTD-L, AND CBD MUST EQUAL 100 PERCENT AND MTD-H/L CANNOT BE ZERO.
- D, THEN MTD-H, MTD-L, MTD-D AND CAD MUST EQUAL 100 PERCENT AND MTD-D CANNOT BE ZERO.

D. IF SMR-3 EQUALS D THEN SMR-4 MUST EQUAL D AND MTD-D AND CAD MUST EQUAL 100 PERCENT.

* 180 MTD NOT BLANK FOR OTHER THAN PA/PC/PG SOURCE * HG.SMRCODHG, HG.OMTDOOHG, HG.FWMTDFPHG, HG.HMTDHHHG, HG.LMTDLLHG, HG.DMTDDDDHG, HG.CBDMTDGHG, HG.CADMTDGHG

* 190 RTD NOT COMPATIBLE WITH SMR (SMR-3) * HG.SMRCODHG, HG.ORTDOOHG, HG.FRTDFFHG, HG.HRTDHHHG, HG.LRTDLLHG, HG.DRTDDDDHG * AN EDIT IS PERFORMED BETWEEN THE SMR AND THE REPLACEMENT TASK DISTRIBUTION (RTD). RTD IS MANDATORY FOR PA, PC AND PG SOURCE CODED ITEMS. OTHERWISE RTD SHOULD BE BLANK.

A. WHEN SMR-4 EQUALS Z AND SMR-3 IS:

- O, THEN RTD-O, RTD-F, RTD-H, RTD-L, AND RTD-D MUST EQUAL 100 PERCENT AND RTD-O CANNOT BE ZERO.
- F, THEN RTD-F, RTD-H, RTD-L, AND RTD-D MUST EQUAL 100 PERCENT AND RTD-F CANNOT BE ZERO.
- H, THEN RTD-H, RTD-L, AND RTD-D MUST EQUAL 100 PERCENT AND RTD-H AND RTD-L CANNOT BE ZERO.
- D, THEN RTD-D MUST EQUAL 100 PERCENT.

B. WHEN SMR-4 EQUALS O SMR-3 MUST EQUAL O AND RTD-O MUST EQUAL 100 PERCENT.

C. WHEN SMR-4 EQUALS F AND SMR-3 IS:

- O, THEN RTD-O, AND RTD-F MUST EQUAL 100 PERCENT AND RTD-O CANNOT BE ZERO.
- F, THEN RTD-F MUST EQUAL 100 PERCENT.

D. WHEN SMR-4 EQUALS H OR L AND SMR-3 IS:

- O, THEN RTD-O, RTD-F, RTD-H, AND RTD-L MUST EQUAL 100 PERCENT AND RTD-O CANNOT BE ZERO.
- F, THEN RTD-F, RTD-H, AND RTD-L, MUST EQUAL 100 PERCENT AND RTD-F CANNOT BE ZERO.
- H, THEN RTD-H, AND RTD-L, MUST EQUAL 100 PERCENT.

E. WHEN SMR-4 EQUALS D AND SMR-3 IS:

- O, THEN RTD-O, RTD-F, RTD-H, RTD-L, AND RTD-D MUST EQUAL 100 PERCENT AND RTD-O CANNOT BE ZERO.
- F, THEN RTD-F, RTD-H, RTD-L, AND RTD-D MUST EQUAL 100 PERCENT AND RTD-F CANNOT BE ZERO.
- H, THEN RTD-H, RTD-L, AND RTD-D MUST EQUAL 100 PERCENT AND RTD-H OR RTD-L CANNOT BE ZERO.
- D, THEN RTD-D MUST EQUAL 100 PERCENT.

* 200 RTD NOT BLANK FOR OTHER THAN PA/PC/PG SOURCE * HG.SMRCODHG, HG.ORTDOOHG, HG.FRTDFFHG, HG.HRTDHHHG, HG.LRTDLLHG, HG.DRTDDDDHG

* 210 MRR MISSING FROM PA/PC OR PG SOURCE * HG.SMRCODHG, HG.MRRONEHG, HG.MRRTHWOG, HG.MRRMODHG * MAINTENANCE REPLACEMENT RATES I, II, AND MODIFIER MUST NOT BE BLANK FOR SOURCE CODES PA, PC AND PG EXCEPT FOR ITEMS WITH "D" IN 3RD POSITION OF SMR.

PROVISIONING REQUIREMENTS
OPTION 1, ARMY EDIT REPORT FOR PCCN A90B10

PART III

- * 220 MAINT REPL RATES/MOD NOT BLANK * HG.SMRCODHG, HG.MRRONEHG, HG.MRRWODHG, HG.MRRMODHG * MAINTENANCE REPLACEMENT RATES I, II, AND MODIFIER MUST BE BLANK FOR SOURCE CODES OTHER THAN PA, PC AND PG AND FOR ALL ITEMS WITH SMR-3 OF D.
- * 230 DMIL AND SMR NOT BLANK OR BOTH * HG.SMRCODHG, HA.DEMILIH * EITHER THE DEMILITARIZATION CODE AND SMR CODE MUST BOTH BE BLANK OR HAVE ENTRIES.
- * 240 PRODUCTION LEAD TIME IS MISSING * HA.PRDLDTHA
- * 250 PHYSICAL SECURITY/PILFERAGE CODE MISSING * HA.PHYSECHA
- * 260 NHA PLISN MISSING (NHA IND OF A, B, OR N) * HH.NHAPLIHH, HH.NHAINDHH * THE NHA PLISN MUST BE IDENTIFIED BY AN NHA PLISN INDICATOR OF A, B, OR N. IF THE INDENTURE CODE FOR THE ITEM IS NOT A, THEN IT MUST HAVE AN NHA PLISN. THERE CAN ONLY BE ONE NHA PLISN INDICATOR OF EITHER N, B OR A; ALL OTHER NHA PLISN S (OVERHAUL/KIT PLISNS) MUST BE EITHER BLANK OR ASTERISK (*). THERE CANNOT BE AN A AND * NHA PLISN INDICATOR FOR THE SAME ITEM.
- * 270 QPEI OR QPA MISSING/QPEI < QPA * HG.QTYASYHG, HG.QTYPEIHG * THE QUANTITY PER ASSEMBLY MUST BE GREATER THAN ZERO.
- * 280 MRR1, MRR1I, OR MRR-MOD MISSING * HG.MRRONEHG, HG.MRRWODHG, HG.MRRMODHG * WHENEVER MAINTENANCE REPLACEMENT RATE (MRR) I, II OR MRR MODIFIER ARE ENTERED, THEN ALL MUST BE ENTERED.
- * 290 RDC OF H, T, R OR S NOT ALLOWED * HJ.RDCODEHU
- * 300 AIC 1ST POS NOT A, AIC QTY BLANK (NOT AD) * HG.ALLOWCHG, HG.ALIQTYHG
- * 310 NHA PLISN > PLISN * HG.PLISNOHG, HH.NHAPLIHH * THE NHA PLISN MUST BE ALPHANUMERICALLY (EBCDIC) LOWER THAN THE PLISN RECORD ON WHICH IT IS CONTAINED.
- * 320 NO SECOND NHA PLISN (* IND CD) * HG.INDCODHG, HH.NHAPLIHH, HH.NHAINDHH * WHEN THE INDENTURE CODE IS ASTERISK, THEN THERE MUST BE TWO NHA PLISNS; THE FIRST WITH AN NHA-IND OF EITHER B OR N, AND THE SECOND WITH AN NHA-IND OF *.
- * 330 NHA SMR NOT A- WHEN NHA-IND A * HH.NHAPLIHH, HH.NHAINDHH, HG.SMRCODHG * IF AN NHA PLISN INDICATOR IS A, THEN THE NHA ITEM MUST BE SOURCE CODED "A-".
- * 340 ASSEMBLED ITEM PIECE PARTS NOT PA/PC SRC * HG.SMRCODHG, HH.NHAPLIHH * WHEN ITEMS CONTAINED SOURCE CODES OF AO - AD, THE PARTS AT THE NEXT LOWER INDENTURE MUST BE SMR SOURCE CODED PA OR PC.
- * 350 SMR ASSY NOT COMPATIBLE WITH SMR PARTS * HG.SMRCODHG, HH.NHAPLIHH * IF THE SMR MAINTENANCE (REPAIR), 4TH POSITION, IS NOT Z OR B, THEN THE NEXT LOWER INDENTURE ITEMS CANNOT BE SMR MAINTENANCE (REMOVE), 3RD POSITION, CODED WITH A MAINTENANCE LEVEL THAT IS HIGHER THAN THE SMR-4 OF THE ASSEMBLY, E.G., AN ASSEMBLY WITH AN SMR OF PAFF CANNOT HAVE COMPONENTS WITH SMRS OF PAHZZ, PADZZ, OR PAHHH. MAINTENANCE LEVELS IN ASCENDING ORDER ARE AS FOLLOWS: C, O, F, H, L, AND D.
- * 360 IND CD OF NHA PLISN NOT ONE LESS THAN PLISN * HG.INDCODHG, HH.NHAPLIHH, XC.INDCODXC * THE NEXT HIGHER PLISN RECORD MUST CONTAIN AN INDENTURE CODE THAT IS ALPHANUMERICALLY (EBCDIC) ONE LESS THAN THE INDENTURE CODE OF THE PLISN RECORD. (EXCEPTION IS ASTERISK INDENTURE CODE FOR PLISN RECORD).
- * 370 UM PRICE NOT LESS THAN UM PRICE OF NHA * HE.UMPRICHE, HH.NHAPLIHH *
- * 380 ORR MISSING FOR P SRC WITH NHA SMR OF P--D- * HG.SMRCODHG, HH.NHAPLIHH, HH.OVHREPHH

FIGURE 39. LSA-036 Summary - continued

PART III OPTION 1, ARMY EDIT REPORT FOR PCCN A90B10

* 390 IND CD AND PLISN INCONSISTENT * HG.INDCODHG, HG.PLISNOHG, XC.PLISNOXC * IF THE INDENTURE CODE (IND CD) IS A, THEN THE PLISN MUST BE BETWEEN AAAA AND AAAHZ. IF THE IND CD IS GREATER THAN A THEN THE PLISN MUST BE GREATER THAN AAAHZ.

* 400 R/S PLISN AND INTCH CD NOT BLANK OR BOTH * HP.RSPLISHP, HP.INTCHHP * EITHER THE REPLACED OR SUPERSEDING (R/S) PLISN AND INTERCHANGEABILITY CODE MUST BOTH BE BLANK OR BOTH BE ENTERED.

PLISN	REFERENCE NUMBER	CAGE	LCN	ALC	EDIT MESSAGE
A123	142-0001	44940	00202		010 MISSING ITEM NAME 020 MISSING UM/UM PRICE 030 UOC NOT 3 POSITIONS 060 ESSENTIALITY CODE MISSING 120 SMR OTHER THAN ARMY ALLOWED CODES 150 MAINT/RECOV NOT EQUAL (OPTION B) 190 RTD NOT COMPATIBLE WITH SMR
F121	142-0001	44940	0050103		010 MISSING ITEM NAME 020 MISSING UM/UM PRICE 150 MAINT/RECOV NOT EQUAL (OPTION B) 190 RTD NOT COMPATIBLE WITH SMR 200 RTD NOT BLANK FOR OTHER THAN PA/PC/PG SOURCE

FIGURE 39. LSA-036 Summary - continued

PROVISIONING REQUIREMENTS

PART III OPTION 2, AIR FORCE L CARD FOR PCCN A90B10

AIR FORCE L CARDS ARE DISPLAYED IN THIS SECTION OF THE REPORT FROM A SORTED FILE EXTERNAL TO THE LSAR DATA TABLES IN ASCENDING PLISN AND CFI SEQUENCE. IF THE TAPE OPTION IS REQUESTED THE L CARDS ARE MERGED WITH THE LSA-036 A-K CARD RECORDS.

.....1.....2.....3.....4.....5.....6.....7.....8
 A90B10A123 E 18 0007C1 01L
 A90B10A123 3220008763125 3218916590/902 02L
 A90B10A123 95JUN0010AUG0008OCT0013 03L
1.....2.....3.....4.....5.....6.....7.....8

(REPORT WITHOUT HEADER OPTION)

1-6	7-11	12	13	14	15	16-17	18-19	20-23	24	25	26	27	28-31	32-33	34	35	36	37-39	40-63	64-77	78-79	80					
PCCN	PLISN	CC	CH	NK	WC	QTY	ATC	WRMC	QTY	I	J	S	SI	RULE	CA	S	SM	A	MIE	NK	NUMBER	BL	REQUISITION	CS	CF		
A90B10	A123	-	E	W	18	--	0007	C	1	-	-	-	-	-	-	-	-	-	-	-	-	-	-	-	01	L	
1-6	7-11	12	13-25	26-27	28-32	33-64	65-77	78-79	80														CS	CF			
PCCN	PLISN	CC	STOCK NUMBER	MMAC	SUBSTITUTE	CAGE	SUBSTITUTE REFERENCE NUMBER	BLANK															N	I			
A90B10	A123	-	3220008763125	--	32189	16590/902																02	L				
1-6	7-11	12	13-14	15-16	17-19	20-23	24-26	27-30	31-33	34-37	38-40	41-44	45-47	48-51	52-54	55-58	59-61	62-65	66-71	72-77	78-79	80			CS	CF	
PCCN	PLISN	CC	YEAR	MONTH	QTY	MONTH	QTY	MONTH	QTY	MONTH	QTY	MONTH	QTY	MONTH	QTY	MONTH	QTY	MONTH	QTY	MONTH	QTY	MONTH	QTY	NATION	ELIN	N	I
A90B10	A123	-	--	95	JUN	0010	AUG	0008	OCT	0013	---	---	---	---	---	---	---	---	---	---	---	---	---	---	---	03	L

(REPORT WITH HEADER OPTION)

FIGURE 39. LSA-036 Summary - continued

SPARES AND SUPPORT EQUIPMENT IDENTIFICATION LIST

EIAC	LCN NOMENCLATURE	START LCN	ALC TYPE	STOP LCN	UOC	ICC SELECTED	RPT PT
REFRIG-UNIT	REFRIGERATION UNIT	0	P 0	0	DCY	BZQX	YYYY

SECTION A: INVESTMENT SPARES; REPAIR PARTS AND SUPPLIES

MANUFACTURERS	ITEM NAME	CAGE	EC	MTBF	MB	QTY/EI	QTY/REC	PLT	PMIC	DMILC	SLAC	UNIT OF MEASURE	UM
PART NUMBER	CARD ASSY/DPIO	18655	1	20000.0(P)	H	2	1	8	A	B	33	PRICE	1535.00
1240D1													
EA													

SECTION B: EXPENSE SPARES, REPAIR PARTS AND SUPPLIES

MANUFACTURERS	ITEM NAME	CAGE	PLT	LRU	UNIT OF MEASURE	UM
PART NUMBER	LAMP DRIVER	62623	10	Y	PRICE	EA
112202-01					541.83	

SECTION C: SUPPORT EQUIPMENT

MANUFACTURERS	ITEM NAME	QTY	REC	CAGE	PMIC	DMILC	UNIT OF MEASURE	UM
PART NUMBER	OSCILLOSCOPE	1	28480	A	B		PRICE	EA
HP5411D							3150.00	

SECTION D: TOOLS AND TEST EQUIPMENT

MANUFACTURERS	ITEM NAME	CAGE	PLT	UNIT OF MEASURE	UM
PART NUMBER	PROBE/TEST	28480	6	PRICE	EA
P6015				176.50	

FIGURE 40. LSA-037 Summary

CRITICAL AND STRATEGIC ITEM SUMMARY

ETAC REFRIG-UNT	ITEM NAME	START LCN	ALC TYPE	STOP LCN	UOC DCY	PARTS ALL	SEQ PT I LCN	SEQ PT II LCN
		0	P					

CRITICAL ITEM CODE(S) SELECTED: INDUSTRIAL MATERIALS ANALYSIS OF CAPABILITY (1ST POS) SELECTED:
ALL

PART I CRITICAL ITEM LISTING

LCN	ALC	WUC	CAGE	REFERENCE NUMBER	ITEM NAME	UI	CRIT ITEM CD	QPA
00201	00	04AA	44940	EC1231980	CONNECTION ROD,PIST	EA	BCACOFD	0001
0020104	00	04CF	12890	LEAD-123-90/40	BUSHING, CONNECTING	EA	MCALLPQ	0006
0030401	00	05AA	67902	114-0204	RING, RETAINING	EA	PFDSSQ	0006
00402	00	051101	44940	113-153	BEARING, ROD, HALF	PR	PLLPQ	0006

PART II CRITICAL AND STRATEGIC MATERIAL LISTING

LCN	CAGE	ALC	WUC	PLISN	NHA-PLISN	NHA-IND	ITEM-NAME	UI	MAT-WT	MAT-LEAD	QPA	IMAC	
002011507	10825	00	0205	AA01	AAAV	N	POWER SUPPLY	EA	001.342	104	0001	EELCT-PT	GOLD
					44940		129A123/4R						
0040106	16585	00	0485	ACYU	AB01	N	BEARING, BALL	EA	000.150	156	0006	MMECH-PT	RUTHEN
					33291		1907812-09						
0040515	87091	00	0492	ADAQ	ADWR	N	WIDGET	EA	010.432	052	0001	FFORM	PLATNM
					13126		198/890123						
005120412AA	54679	00	0548	AEAN	AD06	N	POWER SUPPLY	EA	000.539	104	0002	EELCT-PT	SILVER
					44940		1433-15430						

FIGURE 41. LSA-039 Summary

AUTHORIZATION LIST ITEMS SUMMARY

EIAC ITEM NAME START LCN ALC TYPE STOP LCN UOC AUTH LISTS SELECTED
 REFRIG-UNT REFRIGERATION UNIT 0 00 P DCY DCY ALL

PART I COMPONENTS OF END ITEM LIST

(1) ILLUS NO	(2) NSN	(3) DESCRIPTION, CAGE AND REFERENCE NUMBER	(4) UM	(5) QTY REQ
1	4310-00-017-0125	BOX, CONNECTOR (IN MOUNT ON SIDE OF UNIT) (05472), 1420-1113/R	EA	2
2	6645-00-089-8842	METER, TIME (IN ELECTRICAL OUTLET ON UNIT SIDE) (16476) 561/34K	EA	1
3	2910-01-163-2725	PUMP, FUEL, METERING AND DISTRIBUTING (IN FUEL CONNECTION PORT) (34125) 10811-34Y	EA	1

PART II BASIC ISSUE ITEMS LIST

(1) ILLUS NO	(2) NSN	(3) DESCRIPTION, CAGE AND REFERENCE NUMBER	(4) UM	(5) QTY REQ
4	4930-00-766-7629	LUBRICATING GUN, HAND HIGH PRESSURE (IN TOOL BAG) (36251) 102758	EA	1
5	8415-00-266-8843	MITTENS, CLOTH PAIR M1942 (IN ODDMENT TRAY) (19207) 11655982	PR	1
6	5340-00-682-1508	PADLOCK, SET 1-3/4 W CLEVIS - INCLUDES 1 LOCK AND 2 KEYS (ON BACK PANEL) (80063) SMD555531-1	EA	1
7	7240-00-160-0455	PAIL, UTILITY 14 QUART CAPACITY (INSIDE UNIT) (81348) RRP35	EA	1

FIGURE 42. LSA-040 Summary (Option 1).

AUTHORIZATION LIST ITEMS SUMMARY

PART III

ADDITIONAL AUTHORIZATION LIST

(1) NSN	(2) DESCRIPTION CAGE AND REFERENCE NUMBER	(3) UM	(4) QTY AUTH
ADDITIONAL AUTHORIZATION LIST - MTOE AUTHORIZED			
3410-00-145-8795	GENERATOR SET, 5 KW, DCZ	EA	1
6410-00-128-1325	TRAILER, UTILITY DCY, DCX, DCZ	EA	1
ADDITIONAL AUTHORIZATION LIST - OTHER AUTHORIZED			
2315-00-239-4484	CAN, GASOLINE, 16 GAL DCY, DCX	EA	1
5310-00-321-8984	SHOVEL DCZ,	EA	1

PART IV

EXPENDABLE/DURABLE SUPPLIES AND MATERIALS LIST

(1) ITEM NO	(2) LEVEL	(3) NSN	(4) DESCRIPTION, CAGE AND REFERENCE NUMBER	(5) UM
1	C	2310-00-198-8710	FUEL, DIESEL	GL
2	C	2310-00-178-9800	FUEL, GASOLINE	GL
3	C	2310-00-124-7856	OIL, LUBRICATING	QT

FIGURE 42. LSA-040 Summary (Option 1) - continued

AUTHORIZATION LIST ITEMS SUMMARY

STOCKAGE LIST TYPE THREE

SELECTION SUMMARY

EIAC

REFRIG-UNT

ITEM NAME	START LCN	ALC TYPE	STOP LCN	UOC
REFRIGERATION UNIT	0	00	P	DCY

TM DESIGNATION LIST OF COMPONENTS REQUIRED

SL-3-88643E	SUPPLY SYSTEM RESPONSIBILITY	YES
	USING UNIT RESPONSIBILITY	YES
	COLLATERAL EQUIPMENT	YES

FIGURE 42. LSA-040 Summary (Option 2)

1	2	3	4	5	6	7	ALC	AIC
ITEM NO.	NATIONAL STOCK NUMBER	REF DESIG FIG-KEY	MODEL	ITEM IDENTIFICATION	UM	QTY USED IN UNIT	LCN	
1	4420-00-189-3876	002-0001	DCY	COMPRESSOR UNIT	EA	1	005	00 AA
2	4130-01-091-9159	002-0011	DCY	001 COMPRESSOR ASSEMBLY	EA		00506	00 AD
3	3150-00-976-9349	003-0001	DCY	ENGINE, GASOLINE	EA	1	006	00 AA
4	6620-01-101-3214	003-0008	DCY	004 PISTON ASSEMBLY	EA		00602	00 AD
5	2910-00-358-5618	003-0168	DCY	001 CARBURETOR ASSEMBLY	EA		00607	00 AD

FIGURE 42. LSA-040 Summary (Option 2) - continued

1	2	3	4	5	6	7
ITEM NO.	NATIONAL STOCK NUMBER	REF DESIG FIG-KEY	MODEL	ITEM IDENTIFICATION	UM	QTY USED IN UNIT
6	6645-00-089-8842	014-0018	DCY	METER TIME	EA	1
7	5975-00-152-1144	019-0034	DCY	BOX, CONNECTOR	EA	2
8	3110-01-013-8645	021-0008	DCY	VALVE, SERVICE	EA	1
9	5890-00-892-1674	021-0010	DCY	COUPLING, FEMALE	EA	1
10	5490-00-091-0982	021-0018	DCY	DISK, VALVE	EA	1
11	4790-01-003-1244	024-0011	DCY	DOOR, LEFT	EA	3
12	4125-00-987-8842	034-0018	DCY	STARTER ASSEMBLY	EA	1

LCN ALC AIC

00702 00 AC

00785 00 AC

0079001 00 AC

0079002 00 AC

0079003 00 AC

0079004 00 AC

0079005 00 AC

FIGURE 42. LSA-040 Summary (Option 2) - continued

1	2	3	4	5	6	7			
ITEM NO.	NATIONAL STOCK NUMBER	REF DESIG FIG-KEY	MODEL	ITEM IDENTIFICATION	UM	QTY USED IN UNIT	LCN	ALC	AIC
13	3410-00-145-8795	036-0004	DCY	GENERATOR SET, 5 KW	EA	1	008	00	AE
14	6410-00-128-1325	036-0007	DCY	TRAILER, UTILITY	EA	1	009	00	AE
15	7240-00-160-0455	036-0009	DCY	PAIL, UTILITY	EA	1	010	00	AE
16	5340-00-682-1508	036-0011	DCY	PADLOCK, SET	EA	1	011	00	AE

FIGURE 42. LSA-040 Summary (Option 2) - continued

CAGE	ADDRESS	CAGE	ADDRESS
00779	TOLEDO ELECTRONICS 105 EAST HIGH ST TOLEDO, OH 46217	11215	YORK MANUFACTURING 1324 CHAMBERSBURG ROAD YORK, PA 16189
33210	ACME ELECTRONICS 6145 ROADRUNNER AVE MIDLAND TX 75901	62122	BIG DEFENSE INDUSTRY GUYS 1 BIG DEFENSE PLAZA SUNNYVALE, CA 96107

FIGURE 42. LSA-040 Summary (Option 2) - continued

NUCLEAR HARDNESS CRITICAL ITEM SUMMARY

ETAC REFRIG-UNT	ITEM NAME REFRIGERATION UNIT	START LCN 0	ALC TYPE 00	STOP LCN P	IMC	SMR	PCCN	UOC DCY	SEQ OPT REF-NO	IND	QTY/ASSY	QTY/EI
A5051		41947	NUT, TUBE, COUPLING	A	PAOZZ	A90B10	A034	C	6	C	6	14
BC192015		34127	VALVE, SHUTOFF	G	PAOFF	B90134	AACX	B	1	B	1	1
MS27183-123		10855	WASHER, FLAT	A	PAOZZ	A90B10	A031	C	12	C	12	22
MS18802.35		10855	SCREW, CAP, HEX HD	A	PAFZZ	A90B10	F110	E	6	E	6	REF
					PAHZZ	B90134	ACAL	D	4	D	4	4
					PAOZZ	A90B10	A032	C	12	C	12	22
					PAFZZ	A90B10	F111	E	6	E	6	REF
					PAHZZ	B90134	ACAM	D	4	D	4	4

FIGURE 43. LSA-046 Summary

PART I
 FAILURE MODES WITH RCM ANALYSIS

EIAC LCN NOMENCLATURE START LCN ALC TYPE STOP LCN SHSC RPT PT SELECT
 REFRIG-UNT REFRIGURATION UNIT 0 00 P 00602 DCY 2 YYY A

LOGIC UTILIZED: AMCP 750-2

LCN ALC LCN NOMENCLATURE SHSC FMI MPC LOGIC RESULTS FM CRIT
 0 00 00 REFRIGURATION UNIT 2 FAAB B Y NNNN Y ABCDEFGHIJ FAIL PROB 418.78

MTBPM MB FAILURE RATE MB FMR
 7.2 (P) H .0006667 (P) H .607

PREVENTIVE MAINTENANCE ELAPSED
 LCN ALC TASK CODE TIME
 00

RCM REASONING:

LOGIC RESULT OF 01 IS (Y) BECAUSE THE ITEM HAS A SHSC OF (2).
 LOGIC RESULT OF 05 IS (N) BECAUSE THERE ARE NO MEANS OF INSPEC-
 TION ONLY TESTING. LOGIC RESULT OF 06 IS (N) BECAUSE LITTLE
 MAINTENANCE IS DONE. LOGIC RESULTS OF 07 IS (N) BECAUSE THERE
 IS NO ADVERSE RELATIONSHIP. LOGIC RESULT OF 08 IS (N) BECAUSE
 CREW DOES NOT INSPECT THE ITEM. LOGIC RESULT OF 10 IS (Y)
 BECAUSE IMPEDING FAILURE CAN BE DETECTED BY TESTING.
 DISPOSITION OF A IS (Y) BECAUSE TESTING IS ACCEPTABLE.

RCM REDESIGN/NARRATIVE:
 NOT APPLICABLE.

RCM AGE EXPLORATION NARRATIVE:
 NOT APPLICABLE.

LCN ALC LCN NOMENCLATURE SHSC FMI MPC LOGIC RESULTS FM CRIT LCN
 0 00 00 REFRIGURATION UNIT 2 FAAA A Y Y 1234567890123456789012345
 ABCDEFGHIJ FAIL PROB 358.95

MTBPM MB FAILURE RATE MB FMR
 7.2 (P) H .0006667 (P) H .607

PREVENTIVE MAINTENANCE ELAPSED
 LCN ALC TASK CODE TIME
 005 00 ABCACAA .27 (P) LCN 005
 00 ABCACAA .12 (P)

RCM REASONING:

LOGIC RESULT(01) IS (Y) BECAUSE SHSC IS (2). LOGIC RESULT(05) IS
 (Y) BECAUSE OPERATOR CAN DETECT IMPENDING FAILURE. LOGIC
 RESULT(11) IS (Y) MONITORING IS EFFECTIVE. DISPOSITION(B),
 SCHEDULED MAINTENANCE IS ACCEPTABLE.

RCM REDESIGN/NARRATIVE:
 NOT APPLICABLE.

RCM AGE EXPLORATION NARRATIVE:
 NOT APPLICABLE.

FIGURE 44. LSA-050 Summary

PART II
 RCM MANAGEMENT SUMMARY
 EIAC LCN NOMENCLATURE START LCN STOP LCN UOC SHSC RPT PT SELECT DISP
 REFRIG-UNIT REFRIGURATION UNIT 00602 00 TYPE P 00603 DCY 23 YYY

LCN INHERENT AVAILABILITY END ITEM
 0 95.000000

MAINTENANCE LEVEL: CREW
 LCN ALC LCN NOMENCLATURE AOR MB IA DISPOSITION ABCDEFGHIJ
 00602 00 PISTON ASSEMBLY 7200 H 95.000000 Y

LCN	ALC	TASK CODE	TASK	TABLE	CA	TASK FREQ	MAN HOURS	ELAPSED TIME	MAINTENANCE INTERVAL	MB
00602	00	FBCAGAA	45.0000	45.0000			.35 (M)	.45 (M)	200.0	H
		PERSON ID	SSC	SL	MAN-MINUTES					
		A	76J10	B	0.15					
		B	36C20	B	0.20					
LCN	ALC	SHSC	FEP	MPC	FMI	FAIL MODE	FAILURE RATE		CONV FACT	FM CRIT/ FAIL PROB
00602	00	2	.60	A	FAAA	1.000	.0006667 (P)	H	20050	358.95
		3		B						40.20

LCN	ALC	TASK CODE	TASK	TABLE	CA	TASK FREQ	MAN HOURS	ELAPSED TIME	MAINTENANCE INTERVAL	MB
0060201	00	DBCAGAA	72.0000	72.0000			.30 (P)	.15 (P)	100.0	H
		PERSON ID	SSC	SL	MAN-MINUTES					
		A	76J10	B	0.15					
		C	86C20	B	0.15					
LCN	ALC	SHSC	FEP	MPC	FMI	FAIL MODE	FAILURE RATE		CONV FACT	FM CRIT/ FAIL PROB
0060201	00	3	.70	A	FAAA	0.400	.0005000 (M)	H	00001	128.5

SSC	TOTAL MAN-HOURS
76J10	.30
86C20	.15
36C20	.20

FIGURE 44. LSA-050 Summary - continued

RELIABILITY CENTERED MAINTENANCE SUMMARY
PART III

FAILURE MODES WITHOUT RCM ANALYSIS

EIAC	LCN NOMENCLATURE	START LCN	ALC	TYPE	STOP LCN	UOC	SHSC	RPT	PT
REFRIG-UNT	REFRIGERATION UNIT	0	00	P	00602	DCY	3	3	YYY
SHSC	FMI	LCN	ALC	LCN NOMENCLATURE	FM CRIT/FAIL PROB				
3	A	FAAA	00		21.25				
3	B	FAAB			21.25				

FIGURE 44. LSA-050 Summary - continued

FAILURE MODE, EFFECTS AND CRITICALITY ANALYSIS (FMECA) REPORT
 PART I (FMECA) WORKSHEET SUMMARY

LCN NOMENCLATURE START LCN STOP LCN UOC SERV DES RPT PR SHSC
 REFRIG-UNT REFRIGURATION UNIT 0 00 F DCY NAVY YYY 1234

LCN ALC LCN-TYPE LCN NOMENCLATURE FAILURE RATE MB I C FAIL RATE SOURCE
 0 00 F REFRIGURATION UNIT 0.002346100 (M) O P GIDEP

DRAWING NUMBER REFERENCE NUMBER CAGE
 1451-109832

ITEM FUNCTION:
 PROVIDES REFRIGERATED AIR FOR AN ENCLOSED SPACE, MAINTAINING A
 TEMPERATURE BETWEEN 0 AND 50 DEGREES F (-18 AND 10 DEGREES C).

CRIT CRIT	TABLE BK	CALCULATED	CRIT CRIT	TABLE BK	CALCULATED	CRIT CRIT	TABLE BK	CALCULATED
A	2	844.0934910	B	2	299.1277500	B	3	160.1213250
MPC SHSC	ITEM CRIT NO	ITEM CRIT NO	MPC SHSC	ITEM CRIT NO	ITEM CRIT NO	MPC SHSC	ITEM CRIT NO	ITEM CRIT NO

MINIMUM EQUIPMENT LIST NARRATIVE:
 NOT APPLICABLE.
 LOG CON CD LOGISTICS CONSIDERATIONS/SYSTEM REDESIGN:
 B RECOMMEND REDESIGN OF REFRIGERATION UNIT IN ORDER TO IMPROVE
 ACCESSIBILITY TO COMPRESSOR ASSEMBLY.

FMI FM-RATIO EFM-MTBF MB
 FAAA 0.182 2341.975222 O

1. FAILURE MODE:
 POOR PERFORMANCE.
2. FAILURE CAUSE:
 DUE TO INSUFFICIENT COOLING.
3. FAILURE EFFECTS: LOCAL: INSUFFICIENT COOLING.
 NEXT HIGHER: MISSION DEGRADATION.
 END EFFECT: MISSION DEGRADATION.
4. FAILURE DETECTION METHOD:
 OBSERVANCE OF OPERATIONAL CHARACTERISTICS - HUMAN DETECTION.

FIGURE 45. LSA-056 Summary

FAILURE MODE, EFFECTS AND CRITICALITY ANALYSIS (FMECA) REPORT

5. FAILURE PREDICTABILITY:

NOT APPLICABLE.

6. REMARKS:

NOT APPLICABLE

CORRECTIVE MAINTENANCE TASKS FOR LCN 0 , ALC 00 , FMI FAAA:
 TASK-ALC TASK CODE TASK-LCN TASK-ALC TASK CODE TASK CODE
 00 NGFNAAA 0 00 JGFNAAA

FAIL
 PROB
 FMI MPC SHSC LVL F-E PROB OPER TIME MB OT TABLE BI CALCULATED
 FAAA A 2 B 0.83 0001.00 O 354.4018660 FM CRIT NO FM CRIT NO
 354.4018660

1. MISSION PHASE/OPERATIONAL MODE:

FAILURE OCCURS DURING SYSTEM COOLING PHASE.

2. COMPENSATING DESIGN PROVISIONS:

NONE.

3. COMPENSATING OPERATOR ACTION PROVISIONS:

OPERATOR PROCEDURES MONITORING UNIT PERFORMANCE AND ROOM TEMPERATURE.

4. SYSTEM REDESIGN:

NONE.

FAIL
 PROB
 FMI MPC SHSC LVL F-E PROB OPER TIME MB OT TABLE BI CALCULATED
 FAAA B 3 C 0.75 0000.50 O 160.1213250 FM CRIT NO FM CRIT NO
 160.1213250

1. MISSION PHASE/OPERATIONAL MODE:

FAILURE OCCURS DURING SYSTEM START-UP PHASE.

2. COMPENSATING DESIGN PROVISIONS:

NONE.

3. COMPENSATING OPERATOR ACTION PROVISIONS:

NONE.

4. SYSTEM REDESIGN:

NONE.

FIGURE 45. LSA-056 Summary - continued

FAILURE MODE, EFFECTS AND CRITICALITY ANALYSIS (FMECA) REPORT

FMI FM-RATIO EFM-MTBF MB
 FAAB 0.255 1671.525233 0

1. FAILURE MODE:

COMPRESSOR FAILURE.

2. FAILURE CAUSE:

GASKET LEAK

3. FAILURE EFFECTS: LOCAL: INSUFFICIENT COOLING.

NEXT HIGHER: LOSS OF MISSION.

END EFFECT: LOSS OF MISSION.

4. FAILURE DETECTION METHOD:

OBSERVANCE OF OPERATIONAL CHARACTERISTICS - HUMAN DETECTION.

5. FAILURE PREDICTABILITY:

NOISY OPERATION, INSUFFICIENT COOLING.

6. REMARKS:

NOT APPLICABLE

CORRECTIVE MAINTENANCE TASKS FOR LCN 0 , ALC 00 , FMI FAAB:
 TASK-LCN TASK-ALC TASK CODE TASK-LCN TASK CODE TASK CODE
 0 00 NGONAAA 005 00 HGNAAAA

FAIL	PROB	OT	TABLE BI	CALCULATED
FMI MPC SHSC LVL F-E PROB OPER TIME MB FM CRIT NO				
FAAB A 2 B 1.00 0000.75 O 488.6916250 488.6916250				

1. MISSION PHASE/OPERATIONAL MODE:

FAILURE OCCURS DURING SYSTEM COOLING PHASE.

2. COMPENSATING DESIGN PROVISIONS:

NONE.

3. COMPENSATING OPERATOR ACTION PROVISIONS:

NONE.

4. SYSTEM REDESIGN:

NONE.

FIGURE 45. LSA-056 Summary - continued

FAILURE MODE, EFFECTS AND CRITICALITY ANALYSIS (FMECA) REPORT

FAIL PROB	F-E PROB	OPER TIME	OT	TABLE BI	CALCULATED
FMI MPC SHSC LVL		MB	FM CRIT NO	FM CRIT NO	
FAAB B 2 B	1.00	0000.50	O	299.1277500	299.1277500

1. MISSION PHASE/OPERATIONAL MODE:

FAILURE OCCURS DURING SYSTEM START-UP PHASE.

2. COMPENSATING DESIGN PROVISIONS:

NONE.

3. COMPENSATING OPERATOR ACTION PROVISIONS:

NONE.

4. SYSTEM REDESIGN:

NONE.

----- DAMAGE MODE AND EFFECTS ANALYSIS -----

DMI 1. DAMAGE MODE:

DA01 RUST AND CORROSION DETERIORATING THE SYSTEM OPERATION.

2. DAMAGE EFFECTS: LOCAL:

NEXT HIGHER:

END EFFECT: INCREASED SUSCEPTIBILITY TO CORROSION, AND IN THE EVENT THAT INTERNAL COMPONENTS ARE EXPOSED, THE UNIT WILL BE MORE SUSCEPTIBLE TO DAMAGE AND MAY PRESENT A SAFETY HAZARD. THIS DAMAGE MODE IS RELATED TO ONE OR MORE OF THE FOLLOWING FAILURE MODES: AAC, AAE, AAF AND AAG.

3. REMARKS:

A FINE RUST LAYER NEAR THE CONDENSATION DRIP PIPE IS ACCEPTABLE.

FIGURE 45. LSA-056 Summary - continued

PART II CRITICALITY ANALYSIS SUMMARY

FM CRIT SEL	LCN NOMENCLATURE	ALC	FMI	TM	FGC	LCN NOMENCLATURE	ALC	TYPE	STOP	LCN	UOC	SERV DES	RPT PR	SHSC
	REFRIG-UNT										DCY	NAVY	YYY	1234
FPL	LCN	ALC	FMI	TM	FGC	LCN NOMENCLATURE	ALC			REFERENCE NUMBER	CAGE	FAIL RATE SOURCE		
A	00607	00	FAAB	0603	0603	CARBURETOR ASSY	00	P	142-0431	7890123456789012	44940	GIDEP		
FPL	LCN	ALC	FMI	TM	FGC	LCN NOMENCLATURE	ALC			REFERENCE NUMBER	CAGE	FAIL RATE SOURCE		
B	006	00	FAAA	06	06	ENGINE ASSY	00		CCKA-MS/3834J	44940	GIDEP			
FPL	LCN	ALC	FMI	TM	FGC	LCN NOMENCLATURE	ALC			REFERENCE NUMBER	CAGE	FAIL RATE SOURCE		
B	00602	00	FAAA	0602	0602	ENGINE BLOCK	00		110-1860	44940	GIDEP			
FPL	LCN	ALC	FMI	TM	FGC	LCN NOMENCLATURE	ALC			REFERENCE NUMBER	CAGE	FAIL RATE SOURCE		
B	0060201	00	FAAA	060201	060201	PISTON ASSY	00		BC1920	44940	GIDEP			
FPL	LCN	ALC	FMI	TM	FGC	LCN NOMENCLATURE	ALC			REFERENCE NUMBER	CAGE	FAIL RATE SOURCE		
B	00607	00	FAAA	0603	0603	CARBURETOR ASSY	00		142-0431	44940	GIDEP			

FIGURE 45. LSA-056 Summary - continued

PART III FAILURE MODE ANALYSIS SUMMARY

EIAC REFRIG-UNT	LCN NOMENCLATURE REFRIGURATION UNIT	START LCN 0	ALC 00	TYPE F	STOP LCN	FEP	F-M RATIO	UOC DCY	SERV DES NAVY	RPT PR YYY	SHSC 1234		
LCN	ALC PART F-RATE	MB	OP TIME	MB	MPC	SHSC	FMI	FEP	F-M RATIO	UOC DCY	SERV DES NAVY	RPT PR YYY	SHSC 1234
00501	00 .001250 (P)	H	.23	H B	3	3	FAAA	.95	.80	218.50	218.50	05	05
			TOTAL										
00501	00 .0000500 (P)	H	.23	H B	3	3	FAAA	.75	1.00	8.63	8.63	0501	0501
			TOTAL										
006	00 .0012024 (M)	H	.23	H B	2	2	FAAB	.30	.42	110.34	110.34	06	06
	.0 (P)	H	.00	H B	3	3	FAAA	1.00	.03	8.30	8.30	06	06
			TOTAL										
00602	00 .0006667 (M)	H	.23	H B	3	3	FAAA	.70	1.00	107.34	107.34	0602	0602
			TOTAL										
0060201	00 .0006667 (M)	H	.23	H B	2	2	FAAB	.90	.20	30.67	30.67	060201	060201
		H	.23	H B	3	3	FAAA	.90	.80	110.41	110.41	060201	060201
			TOTAL										
00607	00 .0005000 (P)	H	.23	H B	3	3	FAAA	.70	.40	32.20	32.20	0603	0603
		H	.23	H B	3	3	FAAB	.85	.40	39.10	39.10	0603	0603
		H	.23	H B	3	3	FAAC	.90	.20	20.70	20.70	0603	0603
			TOTAL										
00614	00 .0083333 (M)	H	.01	H B	2	2	FAAA	1.00	1.00	8.33	8.33	0614	0614
			TOTAL										

FIGURE 45. LSA-056 Summary - continued

EIAC	LCN NOMENCLATURE	START LCN	ALC	TYPE	STOP LCN	UOC	RPT PT	SELECTION
REFRIG-UNT	WIRE HARNESS ASSY	002	00	P	002	DCY	YY	YYYY
RAM LCN	ALC FMI LCN NOMENCLATURE			REFERENCE NUMBER	CAGE	MPC	SHSC	FM CRIT NO/ FAIL PROB LIVL
002	00 FAAA WIRE HARNESS ASSY	BR549-0076666TG			94833	A	3	599.96
						B	2	78.00

FAILURE/DAMAGE MODE:
 WIRE HARNESS ASSEMBLY FAILURE.

FAILURE CAUSE:
 DEGRADED CONDITION OF THE WIRES.

SYSTEM REDESIGN:

RAM LCN	ALC FMI LCN NOMENCLATURE	REFERENCE NUMBER	CAGE	MPC	SHSC	FM CRIT NO/ FAIL PROB LIVL
002	00 FAAB WIRE HARNESS ASSY	BR549-0076666TG	94833	A	3	67.0
				B	3	123.0

FAILURE/DAMAGE MODE:
 WIRE HARNESS ASSEMBLY CRACKS.

FAILURE CAUSE:
 ENVIRONMENTAL CONDITIONS LEAD TO THE CRACKING OF THE PLASTIC COVER
 WHICH CAUSED THE METAL WIRE TO RUST

SYSTEM REDESIGN:
 COAT WITH AN ENVIRONMENTAL RESISTANT PLASTIC.

LOGISTICS CONSIDERATIONS:

STANDARDIZATION	Y	ACCESSABILITY	Y	MAINTENANCE EASE	Y	SAFETY	Y	TEST POINTS	Z	SKILLS	Y	TRAINING	Y
CONN REMOVAL	Z	PKG AND TRANSP	Y	FAULT LOCATION	Y	LABELLING	Z	DAMAGE PROTECT	Y	CORR AND RUST	CONT	Y	

LOG CON CD

B

RAM LOGISTICS CONSIDERATIONS NARRATIVE:
 RECOMMEND REDESIGN OF REFRIGERATION UNIT IN ORDER TO IMPROVE
 ACCESSIBILITY TO COMPRESSOR ASSEMBLY

FIGURE 46. LSA-058 Summary

RELIABILITY AND MAINTAINABILITY ANALYSIS
PART II MAINTAINABILITY SUMMARY - LEVEL OF REPAIR

EIAC REFRIG-UNT	LCN NOMENCLATURE WIRE HARNESS ASSY	ALC	M/L	FMI	START LCN 002	MPC	SHSC	TM	FGC	ALC	TYPE P	STOP LCN 002	UOC DCY	RPT PR YY	TASK ALC	TASK CODE	ELAPSED TIME	FM CRIT NUMBER
006	00 O	FAAA	A	3	06	006	00	HGOXAAA	1.67 (P)	8.30								
		FAAA	B	3	06	006	00	NGOAAAA	.78 (M)	8.30								
		FAAB	A	2	06	006	00	HGOXAAA	1.67 (P)	110.34								
		FAAB	B	2	06	006	00	NGOAAAA	.78 (M)	110.34								
		FAAB	B	2	06	00607	00	HGOAGAA	.98 (M)	110.34								
		FAAB	B	2	06	00607	00	HGOAGAA	.98 (M)	110.34								
		FAAC	B	3	06	006	00	NGOAAAA	.78 (M)									
		FAAC	A	3	06	00607	00	DGOAAAA	.50 (M)									
		FAAA	A	3	06	006	00	BGFAGAA	.77 (M)	8.30								
		FAAB	A	2	06	006	00	BGFAGAA	.77 (M)	110.34								
		FAAB	A	2	06	00614	00	HGFAGAA	1.03 (M)	110.34								

LCN	ALC	M/L	FMI	MPC	SHSC	TM	FGC	TASK LCN	TASK ALC	TASK CODE	ELAPSED TIME	FM CRIT NUMBER
00602	00	O	FAAA	A	3	00602	006	006	00	NGOAAAA	.78 (M)	107.34
		F	FAAA	A	3	00602	00602	00602	00	GGFAGAA	.59 (M)	107.34
			FAAA	B	3	00602	00602	00602	00	RGFAGAA	.59 (M)	107.34
			FAAA	A	3	00602	0060201	0060201	00	GGFAFAA	.92 (M)	107.34
			FAAA	B	3	00602	0060201	0060201	00	JGFAGAA	1.00 (M)	107.34
			FAAA	B	3	00602	0060201	0060201	00	RGFAGAA	1.08 (M)	107.34

FIGURE 46. LSA-058 Summary - continued

MANPOWER REQUIREMENTS CRITERIA (MARC)

EIAC	LCN NOMENCLATURE	START LCN	ALC TYPE	STOP LCN	UOC	SERV DES	SSC
REFFRIG UNT	REFRIGERATION UNIT 0	00	P		DCY	ARMY	
LCN	ALC REFERENCE NUMBER	CAGE	NATIONAL STOCK NO.	ITEM NAME			
0	00 F10000RG-2	44940	4110-01-074-5175	REFRIGERATION UNIT			

UNSCHEDULED ON-EQUIPMENT MAINTENANCE

SSC	PERSON ID	M-HR PER PERS ID	TASK CODE	TASK IDENTIFICATION	TASK FREQ	M	MTBMA	TASK CRIT
44B10	AAA	0.33	JGFAGAAA	REPAIR REFRIGERATION UNIT	0.2720	O	26470.6	Y

UNSCHEDULED OFF-EQUIPMENT MAINTENANCE

SSC	PERSON ID	M-HR PER PERS ID	TASK CODE	TASK IDENTIFICATION	TASK FREQ	M	MTBMA	TASK CRIT
4C24K	ACH	1.42	JGFAGAAA	REPAIR COOLANT CONTAINER	0.2720	O	26470.6	Y
4C24K	ACI	0.71	JGFAGAAA	REPAIR COOLANT CONTAINER	0.2720	O	26470.6	Y
5C210	ALQ	3.54	JGFAGAAA	REPAIR MOTOR LINKAGE	0.0330	O	2.182E+5	Y

SCHEDULED MAINTENANCE

SSC	PERSON ID	M-HR PER PERS ID	TASK CODE	TASK IDENTIFICATION	TASK FREQ	M	MTBMA	TASK CRIT
44B10	ADC	0.22	ANFAAAA	INSPECT REFRIGERATION UNIT	2.000	O	3600.0	Y
44B10	LPR	0.05	APFAAAA	INSPECT FOR COOLING CONDITION	12.000	O	600.0	Y

FIGURE 47. LSA-065 Summary

LSA-070 SUPPORT EQUIPMENT RECOMMENDATION DATA (SERD)

SELECTION SUMMARY

END ITEM ACRONYM CODE: F14

MANUFACTURER'S PART NUMBER: A31U14200-5

MANUFACTURER'S CAGE CODE: 26512

FIGURE 48. LSA-070 Summary

FUNCTIONAL ANALYSIS:

A requirement exists at the intermediate maintenance level to test, troubleshoot and fault isolate to the SRU level and to perform serviceability tests after repair of the H-60 aircraft LRUs. Support equipment is required to provide the necessary test interface, stimulus, and measurement capability for the following LRU and SRU requirements:

PARAMETER	RANGE	ACCURACY
DC Voltage 3A maximum	10 mV to 10VDC	+/- 1%
AC Voltage 15A maximum	1, 10, 100 VAC	+/- 3%
Resistance	1, 10, 100 ohms	+/- 1%
Frequency	0 to 18 GHz	+/- 0.5%
RF Power	0 to 100 dB	+/- 1 dB
Wave Form (sine, square, triangle, and ramp)	1mHz to 50 MHz	+/- 5% of selected value
Phase	45 to 90 Degrees	+/- 2 Degrees
Phase	90 to 315 Degrees	+/- 5 Degrees

DESCRIPTION AND FUNCTION:

The RADCOM ATE II Test Station, NSN 4920-01-211-2823 is recommended to fulfill the functional requirements. The test station is comprised of the following elements: signal switch section; digital input/output; interface panel; power supplies; signal generators; measurement devices; MIL-STD-1553 bus test unit; RF interface unit; and control and mass storage elements. The RADCOM ATE II Test Station will perform end-to-end and fault isolation tests of airborne UUTs. The Test Station also provides support requirements for analog/hybrid/RF WRAs and SRAs.

Critical or limiting characteristics: The RADCOM ATE II Test Station is designed for operation in a temperature and humidity controlled environment. This limitation must be considered before substitution is considered.

SE NON-PROLIFERATION EFFORT:

All applicable DOD and commercial documents were reviewed. Documentation review included: MIL-STD-2097A, MIL-STD-1364, MIL-HDBK-300 (SE TIF), MIL-HDBK-265, DI-E-7098, NAVAIR 16-1-525, and NAVAIR 19-1-127. The RADCOM ATE II Test Station is the only test station that will satisfy the requirements.

CHARACTERISTICS OF SE:

See Section 6 for characteristics/parametric data.

SERD NO.	REV	REV DT	STATUS (G)	SE ITEM NAME	CAGE	MPR'S PART NUMBER	PAGE I
0000005162	BB	020585	A	RADCOM ATE II	26512	A31U14200-5	

LOGISTIC SUPPORT ANALYSIS RECORD
SUPPORT EQUIPMENT RECOMMENDATION DATA (SERD)
SECTION 1. DESCRIPTION OF REQUIREMENTS

INSTALLATION FACTORS OR OTHER FACILITIES:

None.

ADDITIONAL SKILLS AND SPECIAL TRAINING REQUIREMENTS:

None.

SERD NO.	REV	REV DT	STATUS (G)	SE ITEM NAME	CAGE	MFR'S PART NUMBER	PAGE
0000005162	BB	020585	A	RADCOM ATE II	26512	A31U14200-5	1

FIGURE 48. LSA-070 Summary - continued

ALC PREPARING ACTIVITY ORIG DT CAGE MFR'S PART NUMBER E-CAGE/PN
 Grumman Aerospace Corp. 280284 26512 A31U14200-5 N

SERD NO. REV REV DT STATUS (G) END ARTICLE DESIGNATOR EA NAME ACTION DATE (G)
 0000005162 BB 020585 A H-60 Aircraft 250685

SE ITEM NAME GOVT DESIGNATOR SE FULL ITEM NAME STASCN (G) SKETCH
 RADCOM ATE II AN/USM-467 Test Station, RADCOM, ATE II Y

NATIONAL STOCK NUMBER (NSN) ALT NSN CONTRACT NUMBER RESPONSIBLE AGENCY (G) PSICP (G) ICC CFE/GFE
 PREFIX FSC NIIN SUFFIX NAME CODE PE
 GRX 4920-01-211-2823 EE N N00019-81-C-0172 NAEC52A51 KE 1 G

CAL ITEM CAL REQD SER USER CTIC SM&R (G) TEC (G) TECEVAL (G)
 N Y N N N PEGGD GHUW

TECH MANUAL CODES PROD LEAD TIME 1ST ARTICLE SPCL MGT (G) MGT PLAN (G)
 08, 12, 16 48 250688 A Y

USABLE ON CODES:

----- PHYSICAL DATA -----

LN	WD	HT	UM	WT	UM	HDWR DEV:	PRICE DATA
092.0	034.0	077.5	IN	02800.0	LB	DESIGN DATA:	111,711
092.0	034.0	077.5	IN	02800.0	LB	PASS THRU:	
						ILS:	127,737
SHIPPING MODES (G): Air, sea, land transportable. Wooden shoring required for air transportation.							
						NONRECURRING	
						TOTAL:	
						RECURRING:	1,300,000

SERD NO.	REV	REV DT	STATUS (G)	SE ITEM NAME	CAGE	MFR'S PART NUMBER
0000005162	BB	020585	A	RADCOM ATE II	26512	A31U14200-5

FIGURE 48. LSA-070 Summary - continued

SYSTEM EQUIPMENT REQUIRED (GFAE)

LCN	ALC	CAGE	MFR'S PART NUMBER	UNIT PRICE	GFAE DESIGNATOR	GFAE NAME	QUANTITY	WORK UNIT CODE
NATIONAL STOCK NUMBER PREFIX FSC NIIN SUFFIX								
-----	ALC	CAGE	MFR'S PART NUMBER					WORK UNIT CODE
NATIONAL STOCK NUMBER PREFIX FSC NIIN SUFFIX								
-----	ALC	CAGE	MFR'S PART NUMBER					WORK UNIT CODE
NATIONAL STOCK NUMBER PREFIX FSC NIIN SUFFIX								
-----	ALC	CAGE	MFR'S PART NUMBER					WORK UNIT CODE
NATIONAL STOCK NUMBER PREFIX FSC NIIN SUFFIX								
-----	ALC	CAGE	MFR'S PART NUMBER					WORK UNIT CODE
NATIONAL STOCK NUMBER PREFIX FSC NIIN SUFFIX								
-----	ALC	CAGE	MFR'S PART NUMBER					WORK UNIT CODE

SERD NO.	REV	REV DT	STATUS (G)	SE ITEM NAME	CAGE	MFR'S PART NUMBER
0000005162	BB	020585	A	RADCOM ATE II	26512	A31414200-5

FIGURE 48. LSA-070 Summary - continued

ARTICLES REQUIRING SUPPORT (ARS)
 LCN ALC TASK CODE MAINTENANCE PLAN CAGE MFR'S PART NUMBER
 006 00 QLGNGAA MP-PSE-0462:EK 26512 A34U11800-1
 NATIONAL STOCK NUMBER
 PREFIX FSC NIIN SUFFIX SM&R ARS DESIGNATOR ARS NAME
 2VX5895-01-279-4288 PEGGD J-4429/USM-467 Amplifier Control
 MTBF MB Ai CMRS WORK UNIT CODE ALLOWANCE WORK PKG REF
 20000.0 H 80.000000 N 72TEB00 R5466

LCN ALC TASK CODE MAINTENANCE PLAN CAGE MFR'S PART NUMBER
 NATIONAL STOCK NUMBER
 PREFIX FSC NIIN SUFFIX SM&R ARS DESIGNATOR ARS NAME

MTBF MB Ai CMRS WORK UNIT CODE ALLOWANCE WORK PKG REF

LCN ALC TASK CODE MAINTENANCE PLAN CAGE MFR'S PART NUMBER
 NATIONAL STOCK NUMBER
 PREFIX FSC NIIN SUFFIX SM&R ARS DESIGNATOR ARS NAME

MTBF MB Ai CMRS WORK UNIT CODE ALLOWANCE WORK PKG REF

SERD NO.	REV	REV DT	STATUS (G)	SE ITEM NAME	CAGE	MFR'S PART NUMBER
000005162	BB	020585	A	RADCOM ATE II	26512	A31U14200-5

FIGURE 48. LSA-070 Summary - continued

SUPPORT EQUIPMENT RECOMMENDATION DATA (SERD)
SECTION 1. ADMINISTRATIVE DATA

EQUIVALENT CAGE/PN(S) :

N = No equivalent CAGEs/PNs available.

ALTERNATE NSN(S) :

N = No alternate NSNs available.

REVISION REMARKS:

(REVISION, REVISION DATE, ACTION DATE (G), REVISION REMARKS)

BB, 020585, 250685, system improvements resulting from ECP 999.

AA, 020584, 250684, station reconfiguration. Parametric data summations.

EXPLANATION:

The following information expands/clarifies data element data:

1. LCN/ALC-TBD due to SE and related data keying off CAGE/PN in LSAR.
2. WUC of ATE II Test Station is 72TCO for planning purposes.

SERD NO.	REV	REV DT	STATUS (G)	SE ITEM NAME	CAGE	MFR'S PART NUMBER
000005162	BB	020585	A	RADCOM ATE II	26512	A31U14200-5

FIGURE 48. LSA-070 Summary - continued

SUPPORT EQUIPMENT RECOMMENDATION DATA (SERD)
SECTION 3. SUPERSEDE/DELETION/DISTRIBUTION DATA

SUPERSEDE DATA

SERDS SUPERSEDED BY THIS SERD

SERD NO.	REASON FOR SUPERSEDE	CAGE	MFR'S PART NUMBER	SE ITEM NAME	IC
000005161	F3	26512	A31U14150-1	RADCOM ATE I	

SERDS THAT SUPERSEDE THIS SERD

SERD NO.	REASON FOR SUPERSEDE	CAGE	MFR'S PART NUMBER	SE ITEM NAME	IC

REASON FOR DELETION:

ALLOCATION DATA

ALLOWANCE (G)	SIDN (G)	MLF (G)	LVC (G)	CUST. CODE (G)	DESIG	1	5	9	13	17	25	33	65	126	251	EXT RNG (G)
					DESCRIP. (G)	4	8	12	16	24	32	64	125	250	450	
R5466		I	B			001	001	001	001	001	001	001	001	001	001	X

MOBILE FACILITY (G) SPARE FACTOR (G) REVOLVING ASSET (G)
X Q000 Q000

SPECIFIC AUTHORIZATIONS

NUMBER OF ACTIVITIES (G)	TYPE OF ACTIVITY (G)	NAME/LOCATION OF ACTIVITY (G)	QTY PER ACTIVITY (G)
1	6	NADEP Pensacola, FL	001

SERD NO.	REV	REV DT	STATUS (G)	SE ITEM NAME	CAGE	MFR'S PART NUMBER
000005162	BB	020585	A	RADCOM ATE II	26512	A31U14200-5

FIGURE 48. LSA-070 Summary - continued

SUPPORT EQUIPMENT RECOMMENDATION DATA (SERD)
SECTION 4. DESIGN DATA

REQUIREMENTS	DDCC	CONTRACTOR RECOMMENDED	GOVERNMENT REQUIRED	ESTIMATED PRICE	SCOPE
SE STANDARDIZATION		N			
SE SPECIFICATION		N			
DESIGN ENGINEERING		Y		111711	Level 3 drawings
CONFIGURATION CONTROL		N			
RELIABILITY		N			
MAINTAINABILITY		N			
QUALITY ASSURANCE		N			
SAFETY		N			
HUMAN ENGINEERING		N			
TEST & EVALUATION		N			
COMPUTER RESOURCES		N			
OTHER		N			

DESIGN DATA PRICE
111711

SERD NO.	REV	REV DT	STATUS (G)	SE ITEM NAME	CAGE	MFR'S PART NUMBER
000005162	BB	020585	A	RADCOM ATE II	26512	A31U14200-5

FIGURE 48. LSA-070 Summary - continued

REQUIREMENTS	IRCC	CONTRACTOR RECOMMENDED	GOVERNMENT REQUIRED	ESTIMATED PRICE	SCOPE
ILS PLAN		N			
LSA		N			
MAINTENANCE PLAN		Y		112636	IAW DI-ILSS-80119
SUPPORT MATERIALS LIST		Y		1942	IAW UDI-V-21042
REPAIR OF REPAIRABLES		N			
PROV TECH DOC		Y		13159	IAW DI-V-7002
MASTER INDEX REP		N			
CMRS		N			
FACILITIES MANUALS		N			
TECHNICAL MANUALS		N			
MRCs		N			
ICPs		N			
PHASED SUPPORT PLAN		N			
CPR/R		N			
REWORK STANDARD		N			
NEW START		N			
TRAINING		N			
CETS		N			
PHS&T		N			
OTHER					
				ILS PRICE	
					127737

SERD NO.	REV	REV DT	STATUS (G)	SE ITEM NAME	CAGE	MFR'S PART NUMBER
0000005162	BB	020585	A	RADCOM ATE II	26512	A31U14200-5

FIGURE 48. LSA-070 Summary - continued

SUPPORT EQUIPMENT RECOMMENDATION DATA (SERD)
SECTION 6. SE PARAMETERS AND UUT RELATED INFORMATION

SE PARAMETERS

PGC	I/O	PARAMETER	RANGE FROM	RANGE TO	ACCURACY	R/V	CALIBRATION PROCEDURE
AA	O	Hertz	DC	18 E+9	±5%	R	17-20AW-92(12)

UUT RELATED INFORMATION

UUT INFORMATION

LCN 006 ALC 00 CAGE 26512 MANUFACTURER'S PART NUMBER A34U118001

ITEM NAME Amplifier Control MAINTENANCE PLAN NUMBER MP-PSE-0462:EK TRD

CMRS STAT N CMRS RECMD N ALLOWANCE R5466 WORK PKG REF CONV FACT MTFB 20000.0 MB H PRICE 16,000

UUT PARAMETERS

PGC	I/O	PARAMETER	RANGE FROM	RANGE TO	ACCURACY	R/V	TASK CODE	CMRSP	TAR
AA	I	18 GHz			±5%	V	QLNGAA	N	DES ACT 1:1

FAULT ISOLATED REPLACEABLE UNITS

CAGE	MFR'S PART NUMBER	ITEM NAME	TRD IND	FAULT ISO AMGR	FAULT ISO AMGR	PCT

SERD NO.	REV	REV DT	STATUS (G)	SE ITEM NAME	CAGE	MFR'S PART NUMBER
000005162	BB	020585	A	RADCOM ATE II	26512	A31U14200-5

FIGURE 48. LSA-070 Summary - continued

SUPPORT EQUIPMENT RECOMMENDATION DATA (SERD)
SECTION 6. SE PARAMETERS AND UUT RELATED INFORMATION

OPERATIONAL ATE/TMDE TEST PROGRAM

UUT LCN	ALC	CAGE	MFR'S PART NUMBER	SERD NO.	ITEM NAME	APPORTIONED UNIT COST NONRECURRING	STAN COMP	CTP
005	00	26512	TPD(R)127165-1-*	0000005061	TPD, RR	446		

TEST PROGRAM INSTRUCTION

UUT LCN	ALC	CAGE	MFR'S PART NUMBER	SERD NO.	ITEM NAME	APPORTIONED UNIT COST NONRECURRING	TDP	SELF TEST
005	00	26512	TPI(R)127165-1-* 1234	0000005062	TRI, RR	272		

ADAPTER/CABLE SET/INTERCONNECTING DEVICE

UUT LCN	ALC	CAGE	MFR'S PART NUMBER	SERD NO.	ITEM NAME	APPORTIONED UNIT COST NONRECURRING	COMMON UUT
005	00	26512	123SAV57030-1	0000005064	Cable Set, RX	28085	

ATE TEST STATION

CAGE	MFR'S PART NUMBER	ITEM NAME	GOVERNMENT DESIGNATOR

UUT RELATED REMARKS

1. SE/UUT parametric data for RF attenuation f's within a range of 0 to 100 dBs. Reference Serd Number 000005161 for all test station parametric values.
2. Daily usage = 19.2 hrs. Service life > 20 yrs.
3. UUT requires 260-6XLP (55820) and 2336-YA (80009) or equivalents for support.
4. FIRU, data requirements - N/A.

SERD NO.	REV	REV DT	STATUS (G)	SE ITEM NAME	CAGE	MFR'S PART NUMBER
0000005162	BB	020585	A	RADCOM ATE II	26512	A31U14200-5

FIGURE 48. LSA-070 Summary - continued

SUPPORT EQUIPMENT CANDIDATE LIST

EIAC LCN NOMENCLATURE START LCN ALC STOP LCN UOC SERV DES INITIAL/REISSUE LIST
 REFRIG UNT REFRIGERATION UNIT 005 00599 DCY ALL INITIAL

PART I - SUPPORT EQUIPMENT CANDIDATES

LCN	ALC	LCN NOMENCLATURE	TASK CD	TASK IDENTIFICATION	TM FGC
005		COMPRESSOR ASSY	HGDAAAA	REMOVE AND REPLACE COMPRESSOR ASSY	05
		SE REFERENCE NUMBER	CAGE	SE ITEM NAME	SE NSN
		5D43-139-A	10855	COMPRESSOR, RING	5480001239876
				UNIT PRICE	SMR CODE
				100.00	PAFZZ

DESCRIPTION AND FUNCTION OF SUPPORT EQUIPMENT: BAND TYPE SLEEVE WITH A MECHANICAL LEVERAGE MECHANISM TO FACILI
 TATE EASY REDUCTION OF RING RADII.

FIGURE 49. LSA-071 Summary

SUPPORT EQUIPMENT CANDIDATE LIST

PART II - DISAPPROVED SUPPORT EQUIPMENT CANDIDATES

SE REFERENCE NUMBER	CAGE	SE ITEM NAME	SERD NUMBER	DATE OF GOVT DISPOSITION
---------------------	------	--------------	-------------	--------------------------

FIGURE 49. LSA-071 Summary - continued

TEST MEASUREMENT AND DIAGNOSTIC EQUIPMENT REQUIREMENTS SUMMARY

EIAC LCN NOMENCLATURE START LCN ALC STOP LCN UOC SERV DES SE REFERENCE NUMBER CAGE
REFRIG UNT REFRIGERATION UNIT N/A N/A 5D43-139-A 10855

TMDE ITEM SELECTED BY REFERENCE NUMBER/CAGE: 5D43-139-A 10855

PART I - TMDE TECHNICAL DESCRIPTION

SE REFERENCE NUMBER CAGE ITEM NAME FULL ITEM NAME
5D43-139-A 10855 COMPRESSOR, RING COMPRESSOR, RING, CIRCUMFERENTIAL, BAND

DESCRIPTION AND FUNCTION OF SUPPORT EQUIPMENT: A BAND TYPE SLEEVE WITH A MECHANICAL LEVERAGE MECHANISM TO FACILITATE EASY REDUCTION OF RING RADI.

I/O PARAMETER RANGE FROM RANGE TO RANGE ACCURACY RANGE IS IN INCHES
DIAMETER IN. 2 5
DEPTH WIDTH HEIGHT UM WEIGHT UM VOLTS AC/DC FREQUENCY PHASE WATTS PERCENT MAX RIPPLE
4.0 5.0 5.0 IN 3.5 LB 10 110

ITEMS THIS WILL REPLACE: SUPERCEDED REFERENCE NUMBER CAGE

SKILL SPECIALTY PUBLICATIONS MAINT LEVEL TMDE RAM CHARACTERISTICS NSN AND RELATED DATA
CODE FOR SE MTBF 300.0 MTTR CAL TIME
52C20 .50 1 5820-003478650

TYPE CLASS LIN LOG CONTROL SELF TESTING CAL INTERVAL LIFE CYCLE STATUS UNIT COST
T N 720 D 75.75

END ITEM NSN AND RELATED DATA SE MANAGING COMMAND
4110-010745175 MESA

SE REMARKS: ACCURACY IS NOT APPLICABLE TO THE RING COMPRESSOR

DESCRIPTION OF OPERATING PROCEDURE:

FIGURE 50. LSA-072 Summary

TEST MEASUREMENT AND DIAGNOSTIC EQUIPMENT REQUIREMENTS SUMMARY

PART II - TMDE REQUIREMENTS REVIEW

SUPPORTED LCN ALC SUPPORTED NOMENCLATURE TMDE NON-PROLIFERATION SEARCH
 005 INTERNAL COMPRESSOR THE PROPOSED RING COMPRESSOR IS OF SUFFICIENT CAPACITY TO COMPLY WITH ALL PRESENT DESIGN CRITERIA AND FOR THOSE CRITERIA FORE-SEEABLE IN THE NEAR FUTURE.

SSC MAINT LVL TMDE REG NO TMDE CODE JUSTIFICATION
 52C20 IAJ3114 E
 QUANTITY OF TMDE ITEMS TO BE PROCURED ITEM NAME NATIONAL STOCK NUMBER
 20 901231 ESTIMATED TOTAL COST COMPRESSOR, RING 5820-003478650

CHARACTERISTICS TO BE MEASURED/STIMULUS REQUIRED
 I/O PARAMETER RANGE FROM RANGE TO RANGE ACCURACY
 DIAMETER IN. 32 45 NOT APPLICABLE
 DIAMETER 32 42 NOT APPLICABLE

INTERFACE ADAPTERS/SIGNAL CONDITIONING CIRCUITRY
 APPORTIONED UNIT COST
 RECURRING NONRECURRING
 ITEM NAME REFERENCE NUMBER CAGE APPORTIONED UNIT COST
 ATE SOFTWARE REQUIRED RECURRING NONRECURRING

ITEM NAME REFERENCE NUMBER CAGE APPORTIONED UNIT COST TEST PLAN
 RECURRING NONRECURRING

UNIT UNDER TEST REMARKS: THE RANGE CRITERIA ARE GIVEN IN INCHES.

ESTIMATED TYPE CLASSIFICATION DATE: ___/___/___

PREPARED BY: _____ DATE: ___/___/___

FIGURE 50. LSA-072 Summary -continued

SUPPORT EQUIPMENT TOOL LIST

FIAC LCN NOMENCLATURE START LCN ALC STOP LCN UOC SERV DES ICC - 1 ICC - 2 ICC - 3 ICC - 4
 REFRIG UNT DOOR-SCREEN ASSY 00510 00520 DCY ARMY N 4 * 8

PART I - TOOLS CURRENTLY IN INVENTORY

REFERENCE NUMBER	CAGE	ITEM NAME	ACQ DEC OFFICE	SERD NUMBER	NSN AND RELATED DATA	MAINT LEVEL	ICC
AA123C	13579	TORQUE WRENCH	USAAMCCOM	6018123456		H D	N
A135	44940	SCREWDRIVER	USAAMCCOM	6015123456	5120-00-278-1273	C O F H L D	N
B107-6	44940	WRENCH SET, COMB	USATROSCOM	6007123456	5120-00-148-7917		N
CB9234569	44940	DOLLIE, 4WH	USATROSCOM	6010123456		O	N
KT024683N2	44940	SCISSORS	USATROSCOM	6020123456		O F D	N
K252	44940	HYDROMEMETER	USAAMCCOM	6001123456			N
450K4	12345	KIT, SOLDERING GUN	USAAMCCOM	6005123456	3439-00-930-1638		N

FIGURE 51. LSA-074 Summary

SUPPORT EQUIPMENT TOOL LIST

PART II - TOOLS IN INVENTORY BUT NOT ASSIGNED TO GAINING UNIT

REFERENCE NUMBER	CAGE	ITEM NAME	ACQ DEC OFFICE	SERD NUMBER	SIASCN	SKETCH	MAINT LEVEL	ICC
A24	34521	WRENCH, SOCKET	USAMCCOM	6016123456	MAR-098	N		4
A610	12345	EXT, SOCKET WRENCH	USATROSCOM	6006123456	N45098X			4
B25	44940	TONGS, 7 IN	USATROSCOM	6008123456	N1389XX	F		4
45021	44940	WELDER	USATROSCOM	6019123456	N453-0X	N		4

FIGURE 51. LSA-074 Summary - continued

SUPPORT EQUIPMENT TOOL LIST
 PART III - MODIFIED HAND TOOLS

REFERENCE NUMBER	CAGE	ITEM NAME	ACQ DEC OFFICE	SERD NUMBER	SIASCN	SKETCH	MAINT LEVEL	ICC
CTB1	44940	BUCKET, 3 GAL	USATROSCOM	6011123456	N3412XX	N	F	*
REFERENCE NUMBER	CAGE	ITEM NAME	ACQ DEC OFFICE	SERD NUMBER	SIASCN	SKETCH	MAINT LEVEL	ICC
E3727	44940	SHIM, 1/4 CM	USATROSCOM	6012123456	NI29 (2)	N	O	*
	MAKE FROM	ITEM NAME	REFERENCE NUMBER	CAGE	NSN AND RELATED DATA			
		SLEEVE, CHOKE COVER	142-205	44940				
		DISK, VALVE	142-0055	44940	2910-00-358-5618			
REFERENCE NUMBER	CAGE	ITEM NAME	ACQ DEC OFFICE	SERD NUMBER	SIASCN	SKETCH	MAINT LEVEL	ICC
SN517832105	44940	VOLTMETER, 1/3AMP	USACECOM	6003123456	G-CE2/9	Y		*
	MAKE FROM	ITEM NAME	REFERENCE NUMBER	CAGE	NSN AND RELATED DATA			
		ARMATURE	191-1088	44940				
		SLEEVE, CHOKE COVER	142-2054	44940				
		SPRING SET	191-0984	44940				
		SPRING	142-0035	44940	5360-01-066-3450			

FIGURE 51. LSA-074 Summary - continued

SUPPORT EQUIPMENT TOOL LIST

PART IV - PECULIAR TOOLS REQUIRING DEVELOPMENT

REFERENCE NUMBER	CAGE	ITEM NAME	ACQ DEC OFFICE	SERD NUMBER	SIASCN	SKETCH	MAINT LEVEL	ICC
AT503	44940	WRENCH, ADJUSTABLE		6014123456	MAR-023	N	F	8
A26	44940	WRENCH, SOCKET	USAAMCCOM	6017123456	MAR-005	Y		8
B2502	44940	SET, SOCKET	USATROSCOM	6009123456	NR123XX	Y	F H	8
CC586T3692	44940	DITMCO STATION	USATROSCOM	6004123456	N3987XX	N	O	8
FC1036921	44940	BRUSH, WIRE	USATROSCOM	6013123456	N238/2X	Y	H	8
FW25	44940	WRENCH, FILTER	USACECOM	6002123456	G-CE5/7	N		8

FIGURE 51. LSA-074 Summary

MANPOWER PERSONNEL AND TRAINING REPORT

FIAC LCN NOMENCLATURE START LCN ALC TYPE STOP LCN UOC SERV DES MAINT LVLS SSC AVAILABLE M-H PEACE/WAR
 REFRIG UNIT REFRIGERATION UNIT 0 P

LCN 0 ALC LCN NOMENCLATURE REFRIGERATION UNIT

PART I - MANPOWER AND PERSONNEL SUMMARY

SSC	MAINTENANCE LEVEL	AVAIL M-H	ACTUAL M-H	AVAIL QTY	ACTUAL QTY
35B20	OPER/CREW (C) ORG/ON EQP (O)	100.00 600.00	.00 668.90	2 1	0 1
35B30	ORG/ON EQP (O) INT/DS/AVIM (F)	1400.00 100.00	1328.90 25.29	2 1	2 1
44B10	INT/DS/AVIM (F)		13.50	0	1
44E10	INT/DS/AVIM (F)	0.00	6.60	0	1
52C10	ORG/ON EQP (O) INT/DS/AVIM (F)	25.00	24.57 15.00	1 0	1 1
52C20	ORG/ON EQP (O) INT/DS/AVIM (F)	600.00 1200.00	624.30 1219.20	1 2	1 2
76J10	OPER/CREW (C)	50.00	54.49	1	1

FIGURE 52. LSA-075 Summary

MANPOWER PERSONNEL AND TRAINING REPORT

NEW OR MODIFIED SKILL AND TRAINING REQUIREMENTS

ORIGINAL SSC	ORIGINAL SLC	NEW/MOD SSC	NEW/MOD SLC	REQUIRING NEW/MOD SKILL	DUTY POSITION	MIL RANK	CIVIL GRADE	SECURITY CLEARANCE	TEST SCORE

RECOMMENDED

XX
 XX
 XX

NEW OR MODIFIED SKILL REQUIREMENTS

EDUCATIONAL QUALIFICATIONS

XX
 XX
 XX

SKILL JUSTIFICATION

XX
 XX
 XX

ADDITIONAL TRAINING REQUIREMENTS

XX
 XX
 XX

PHYSICAL AND MENTAL REQUIREMENTS

XX
 XX
 XX

LCN	TASK CD	SUBTASK NO	ALC	PERSON ID
002	AGCABAA	003	AA	
006	HGOABAA	002	B	AB1

FIGURE 52. LSA-075 Summary - continued

CALIBRATION AND MEASUREMENT REQUIREMENT SUMMARY

ETAC LCN NOMENCLATURE START LCN ALC STOP LCN UOC SERV DES
 FX FX AIRCRAFT 0

SECTION 1. TABLE OF CONTENTS FOR CMRS SUMMARY DATA

LCN	ITEM NAME	REFERENCE NUMBER	CAGE	PAGE
005	ATTITUDE DIRECTOR	CX1	10855	0004

FIGURE 53. LSA-076 Summary

CALIBRATION AND MEASUREMENT REQUIREMENT SUMMARY

SECTION 2. TABLE OF CATEGORY II TMDE

ITEM NAME REFERENCE NUMBER	NSN	ICC MTBF	CAGE	30000	Y	012	CALIBRATION REQ INTVL	OPERATOR'S MANUAL CALIBRATION PROCEDURE	SERD	O/M LEVEL RCCP
DIGITAL MULTIMETER 9XXX	6625-01-131-XXXX 28560	5		30000	Y	012		33D7-34-20-01-1 17-20AGG-11-00XD	0056123456	COFH

FIGURE 53. LSA-076 Summary - continued

CALIBRATION AND MEASUREMENT REQUIREMENT SUMMARY

SECTION 3. TABLE OF CATEGORY III CALIBRATION EQUIPMENT/STANDARDS

ITEM NAME REFERENCE NUMBER	NSN	CAGE	ICC MTBF	5	CALIBRATION REQ	INTVL	OPERATOR'S MANUAL CALIBRATION PROCEDURE	SERD	O/M LEVEL RCCP
PHASE ANALYZER X000A	6625-01-156-XXXX	11289	44890	Y	006				COFH

FIGURE 53. LSA-076 Summary - continued

CALIBRATION AND MEASUREMENT REQUIREMENT SUMMARY

SECTION 4.

CATEGORY I - OPERATION/AIRBORNE EQUIPMENT

LCN	ALC	ITEM NAME	REFERENCE NUMBER	CAGE	AOR	MB	MTBF
005		ATTITUDE DIRECTOR	CX1	10855	7200	0	20000.0

PARAMETER	S/O	I/O	R/V	RANGE FROM	RANGE TO	ACCURACY
mVAC	S	O	V	340.000		+/- 1%

LCN	ALC	TASK CODE	TASK FREQ	MEAN ELAP TIME
005		FBFNAAA	0.5000	6.23

CATEGORY II TMDE

LCN	ALC	PARAMETER	R/V	RANGE FROM	RANGE TO	ACCURACY	LCN	ITEM NAME	R/V	RANGE FROM	RANGE TO	ACCURACY	
600		DIGITAL MULTIMETER	I	1.000		%		REFERENCE NUMBER	I/O	CAGE	REFERENCE NUMBER	CAGE	ACCURACY
		9XXX		mVAC +/- 0.25									

LCN	ALC	PARAMETER	R/V	RANGE FROM	RANGE TO	ACCURACY	LCN	ITEM NAME	R/V	RANGE FROM	RANGE TO	ACCURACY	
		mVAC	R	0				REFERENCE NUMBER	I/O	CAGE	REFERENCE NUMBER	CAGE	ACCURACY
				17-20AGG-11-00XD									

FIGURE 53. LSA-076 Summary - continued

DEPOT MAINTENANCE INTERSERVICE DATA SUMMARY

EIAC	LCN NOMENCLATURE	START LCN	ALC	TYPE	STOP LCN	UOC	SERV DES	ORIGINATING COMMAND
REFFRIG UNIT	REFRIGERATION UNIT	0	00	P		DCY	ARMY	

HEADER DATA:	ITEM DESIGNATOR CODE	CAGE	REFERENCE NUMBER	TOTAL SYSTEMS SUPPORTED	NAT STOCK NUMBER
TYPE1	MODEL02	S SFX12	44940 F10000RG-2	003000	4110-01-074-5175

PART I	JLC 28/29 DATA	DEPOT REPAIRABLE ITEMS/ENGINEERING DRAWINGS									
LCN	ALC	REFERENCE NUMBER	CAGE	ENGRG DRAWING NO	DWC	REV	ITEM NAME	NAT STOCK NUMBER	DAC	QPA	QPEI
002	00	L1090V123-39802.	94833	11902AA	2N	A	WIRE HARNESS ASSEMB	4110-01-074-5175	1	0001	00001
		11123									

TASK CODE	TASK IDENTIFICATION	DEPOT LEVEL TASKS	REQUIREMENT FOR
		FREQUENCY MB	FAC TRN-EQ TOOL
BGDAGAA	TEST WIRE HARNESS ASSEMBLY	000.2000 O	Y Y B
GGDFGAA	INSTALL WIRE HARNESS ASSEMBLY	000.2000 O	N N C
JGDAGAA	REPAIR WIRE HARNESS ASSEMBLY	000.1500 O	Y N C
RGDAGAA	REMOVE WIRE HARNESS ASSEMBLY	000.2000 O	N Y C

ITEM FUNCTION

WIRE HARNESS SERVES AS THE NETWORK OF POWER TRANSMISSION.

LCN	ALC	REFERENCE NUMBER	CAGE	ENGRG DRAWING NO	DWC	REV	ITEM NAME	NAT STOCK NUMBER	DAC	QPA	QPEI
005	00	5D43-139-A	10855	1910877.32-12134	2N	F	COMPRESSOR ASSEMBLY	4130-01-091-9159	1	0001	00001
				.16YLQ							

TASK CODE	TASK IDENTIFICATION	DEPOT LEVEL TASKS	REQUIREMENT FOR
		FREQUENCY MB	FAC TRN-EQ TOOL
HGDAAA	REMOVE AND REPLACE AT DEPOT	000.1215 O	N N C
KRDAAA	OVERHAUL COMPRESSOR AT DEPOT	000.1100 O	N N C

ITEM FUNCTION

COMPRESSES THE REFRIGERANT GAS AND PUMPS IT THROUGH THE SYSTEM.

FIGURE 54. LSA-077 Summary

DEPOT MAINTENANCE INTERSERVICE DATA SUMMARY

PART II SUPPORT EQUIPMENT LIST FOR ALL MAINTENANCE LEVELS AND DEPOT FACILITY REQUIREMENTS

SECTION A. SUPPORT EQUIPMENT LIST

REFERENCE NUMBER	CAGE	ITEM NAME	SUPPORT EQUIPMENT FULL ITEM NAME	GOVERNMENT DESIG	SERD NUMBER	ST	REV
A12891-6	33215	MULTIMETER	MULTIPLE USE ELECTRICAL MEASUREMENT DEV		0728		
CV-1298056/349.3	87012	DEVICE, LEAK DETE	FREON LEAK DETECTION DEVICE, REFRIGERATIO	LPSQM32	02T7	R	C
37/2Y							
LP-1214309Y	66218	DYNOMOMETER	DEVICE, POWER MEASUREMENT, PRECISION		0823	U	SS
11289-654	77125	ANALYZER, EXHAUST	ANALYZER, EXHAUST GAS		8238	C	AA
4003100	24940	SET, SOLDERING HP	REPAIR SET, VACUUM/TEMPERATURE CONTROL	ANUSF1624	00L2	R	A
4003100	32189	RING, COMPRESSOR	COMPRESSOR, RING, BAND		0727	R	AC
4891210.32	32190	BENCH, LEAK DOWN	COMPRESSION LEAK DOWN TEST BENCH	WP23A78	010E	0887	C

SECTION B. NEW OR MODIFIED DEPOT FACILITIES REQUIREMENTS LIST

FACILITY CATEGORY CODE: 23333 FACILITY NAME: FREON FACILITY

LCN	ALC	TASK CODE	LCN	ALC	TASK CODE	LCN	ALC	TASK CODE
005	00	HGDAAAA	005	00	HGDAAAA	0050201	00	KGDAAAA
0050201	00	KGDAAB	0050204	00	KGDAAAA			

FACILITY REQUIREMENT: THE FREON FACILITY IS REQUIRED TO PERFORM REPAIR ON THE REFRIGERATION UNITS BEING DEVELOPED TO SUPPORT THE ARMY MISSION INTO THE TWENTY-FIRST CENTURY. NEW WEAPON DEVELOPMENTS REQUIRE THAT 155 MM ROUNDS BE KEPT AT A TEMPERATURE OF 10 DEGREES CELSIUS. THE REFRIGERATION UNIT REPAIRS WORKLOAD WILL INCREASE BY THREE MILLION PERCENT THUS REQUIRING AN ORGANIC REPAIR FACILITY.

FIGURE 54. LSA-077 Summary - continued

DEPOT MAINTENANCE INTERSERVICE DATA SUMMARY

PART III JLC 30 DATA NEW/UNIQUE DEPOT SUPPORT EQUIPMENT

SUPPORT EQUIPMENT
 REFERENCE NUMBER CAGE ITEM NAME SERD NUMBER ST REV NAT STOCK NUMBER GFE YEAR CFE YEAR TOTAL QUANTITY
 CC56T3692 33721 DITCWO STATION L110 6004 3210-00-321-9865 90 000004

----- NONRECURRING COST -----
 DEVELOPMENT DESIGN PASS-THRU ILS RECURRING GOVERNMENT DESIGNATION
 000321890 000087091 00000000 00004589 00009523 LQ110

TASKS REQUIRING SUPPORT EQUIPMENT
 ALC TASK CODE CONDITION MAN-HOURS ELAPSED TIME
 00 BGDAGAA BC 000.40 (M) 000.65 (M)

PERSON SKILL SPEC SKILL LEVEL MAN-MINUTES
 ID CODE CODE
 AAL 35B30 A 012.8
 ACY 42C20 B 027.2

LCN 00201 ALC TASK CODE CONDITION MAN-HOURS ELAPSED TIME
 00 KGDAGAA BC 000.32 (P) 000.47 (P)

SUPPORT EQUIPMENT
 REFERENCE NUMBER CAGE ITEM NAME SERD NUMBER ST REV NAT STOCK NUMBER GFE YEAR CFE YEAR TOTAL QUANTITY
 SN517832105 01762 VOLTMETER, 1/3 AMP V120 6120 4120-00-967-9865 C 92 000012

----- NONRECURRING COST -----
 DEVELOPMENT DESIGN PASS-THRU ILS RECURRING GOVERNMENT DESIGNATION
 000001289 000002300 00000268 00000699 00000984 VQ84-Q

TASKS REQUIRING SUPPORT EQUIPMENT
 ALC TASK CODE CONDITION MAN-HOURS ELAPSED TIME
 00 KRDAGAA BC 003.75 (P) 003.75 (P)

FIGURE 54. ISA-077 Summary - continued

HAZARDOUS MATERIALS SUMMARY

EIAC	ITEM NAME	START LCN	ALC TYPE	STOP LCN	UC	SERVIC DES	DCY	ARMY	UM	UM PRICE	TOTAL QTY
REFRIG-UNT	REFRIGERATION UNIT	0	00	P							RECOMMENDED
CAGE	REFERENCE NUMBER		ITEM NAME	MATERIALS STORAGE COST	WASTE STORAGE COST	DISPOSAL COST	UM	UM PRICE			
21980	121908.34-09		LEAD IZIDE	00000987	00018902	00026729	PT	4.27			
LCN	ALC	TASK CODE	TASK IDENTIFICATION	QTY/TASK	TASK	FREQ	M	COMPUTED	B	QUANTITY	TOTAL QTY
0181001	00	CACAGAA	SERVICE FUZE FOR MK32 ROUND	000.12	0001.1250	0	0	000000.2	0	000200	
0181001	00	JGOAGAA	REPAIR FUZE FOR MK32 ROUND	001.50	0000.6670	0	0	000001.0	0		
TOTAL QUANTITY REQUIRED: 1.2 PINTS											
CAGE	REFERENCE NUMBER		ITEM NAME	MATERIALS STORAGE COST	WASTE STORAGE COST	DISPOSAL COST	UM	UM PRICE			
33216	89-09121		HYDRAZINE	00003498	00008902	00032128	GL	3.00			
LCN	ALC	TASK CODE	TASK IDENTIFICATION	QTY/TASK	TASK	FREQ	M	COMPUTED	B	QUANTITY	TOTAL QTY
00102	00	CACAGAA	SERVICE AUXILIARY POWER UNIT	012.00	0056.2500	0	0	000675.0	0	001660	
00102	00	CHOAGAA	POST-OPERATIVE FLIGHT SERVICING	017.50	0056.2500	0	0	000984.4	0		
0030401	00	CACAGAA	SERVICE SECONDARY POWER SUPPLY	003.00	0028.1250	0	0	000084.4	0	000300	
0030401	00	CHOAGAA	POST-OP POWER SUPPLY SERVICE	004.50	0028.1250	0	0	000126.6	0		
TOTAL QUANTITY REQUIRED: 1870.4 GALLONS											

FIGURE 55. LSA-078 Summary

BILL OF MATERIALS
PART 1 PARTS LIST

EIAC	ITEM NAME	START LCN	ALC TYPE	STOP LCN	UC	SEQ OPTION	LCN-CODE	PCCN					
REFRIG-UNT	REFRIGERATION UNIT	0	P		DCY	PLISN	CLASSICAL	A90B10					
LINE	PLISN	IC	NHA-PLISN	REFERENCE NUMBER	CAGE	ITEM NAME	SMR	QPA	LCN	ALC	LCN-IC	MRR-I	ERROR
A124	D	A013	BC1920		44940	PISTON ASSEMBLY	PAOFF	2	0060201	00		1.1250	
1	A125	E	A124	112-0069	44940	PN, PISTON	PAFZZ	1	0060201AA	00		0.0671	
2	A126	E	A124	112-0003	44940	RING, RETAINING	PAFZZ	3	0060201AB	00		0.3218	
3	A127	E	A124	114-0203-1234/PA RT/E	44940	CONNECTING ROD, PIST	PAFZZ	1	0060201AC	00		0.1219	
4	A128	E	A124	114-0145	44940	BEARING, ROD, HALF	PAFZZ	2	0060201AD	00		0.1298	
5	A129	E	A124	114-0036	44940	BUSHING, CONNECTING	PA	2	0060201AE	00		0.1198	**
6	A130	E	A124	113-0153	44940	RING SET, PISTON	PAFZZ	4	0060201AF	00		1.0023	
7	A131	E	A124	112-0136	44940	PISTON, INTERNAL COM	XAFZZ	1	0060201AG	00		0.1189	
8	A132	E	A124	116-1845	44940	BOLT, CONNECTING ROD	PAFZZ	2	0060201AH	00		0.0117	
9	A133	E	A124	112-0187	44940	NUT, HEXAGONAL, 3/4	PAFZZ	2	0060201AI	00			

BILL OF MATERIALS
PART 2 ERROR LISTING

ITEMS IN PCCN/LCN RANGE: 14
 ITEMS ON PARTS LIST: 10
 ITEMS ON ERROR LIST ONLY: 4
 ITEMS ON ERROR LIST: 5

ERROR CODES:

- 1 ITEM SMR CODED NONREPAIRABLE WITH PART BREAKDOWN
- 2 PART OF THE PCCN/SELECTED LCN RANGE BUT NOT ATTACHED TO ANY ASSEMBLY OR PART
- 3 NO INDENTURE CODE
- 4 SMR CODE BLANK OR INCOMPLETE
- 5 DUPLICATE LCNS WHEN CLASSICAL ASSIGNMENT IS SPECIFIED
- 6 RECOVERABILITY CODE IN ERROR
- 7 SMR CODED REPAIRABLE ASSEMBLY WITH NO PARTS

PLISN	IC	CAGE	REFERENCE NUMBER	ITEM NAME	QPA	SMR	NHA-PLISN	LCN	ALC	ERROR REASON
										1 2 3 4 5 6 7
AAAA	A	44940	CCKA-MS/1423	REFRIGERATION UNIT	1	PEOZZ		0		Y
A001	B	44940	11890-12	ENGINE, INTERNAL CO	1	PAOHH	AAAA	006	00	Y
A129	E	44940	114-0036	BUSHING, CONNECTING	2	PA	A124	0060201AE	00	Y
A312	C	44940	118-0192	CARBURETOR ASSEMBLY	1	PAOFF	AAAA	0060701	00	Y
A362	E	44940	118-3210	CHOKE, PULLY ASSEMB	1	PAOZZ	A342	006070101AAA	00	Y

FIGURE 56. LSA-080 Summary

EIAC LCN NOMENCLATURE START LCN ALC TYPE STOP LCN UOC
 M113A3 M113A3 APC (WAK) 0 00 P 0 DCY

REFERENCE NUMBER CAGE NATIONAL STOCK NUMBER CONTRACT NUMBER REVISION TYPE THEATER
 F1000111RG-2 45940 2350-01-219-7577 DAAA21-12145 900301 N PAESC

CONTRACTOR NAME AND LOCATION: STATE NATION POSTAL ZONE
 FWA CORPORATION STREET CITY LONG BEACH NY UNITED STATES 98001
 114 BAJA ST.

PROCUREMENT SCHEDULE:
 FY 1QTY 2QTY 3QTY 4QTY FY 1QTY 2QTY 3QTY 4QTY FY 1QTY 2QTY 3QTY 4QTY FY 1QTY 2QTY 3QTY 4QTY
 90 010 010 020 020 91 003 005 009 016 92 022 016 015 014 93 010 009 004 004 94 010 008 004 002

MILITARY UNIT TYPE:
 THIS UNIT WILL BE TRANSPORTED BY A GROUND TRANSPORTATION COMPANY; FIXED WING C-130, C-141, AND C-5 UNITS; HELICOPTERS CH-47 AND CH-53 UNITS. THIS UNIT WILL BE USED BY DIFFERENT ARMORED DIVISIONS.

PROPER SHIPPING NAME
 M113A ARMORED PERSONNEL CARRIER (WITHOUT ARMOR KIT) NOFF NET EXP WEIGHT SPEED TOWING SPEED SECT ID
 1000 40 10

-- SHIPPING MODES --

FREIGHT SHIPPING CONTAINER RAIL
 CLASSIFICATION CONFIGURATION LENGTH CONAINER TYPE USE
 01223AZ VE CGABU

RAIL TRANSPORTATION COUNTRY OR COUNTRIES:
 UNITED STATES

HIGHWAY PRIME MODEL HIGHWAY ALTERNATE MODEL SHIP DECK LIGHTERAGE DECK
 LOAD TYPE LOAD TYPE ITEM DESIGNATOR BREAK BULK RORO BARGE STOWAGE ITEM DESIGNATOR LARC-XV STOWAGE
 B M931A1/M172A1 B M851A2/M172A1 Y Y Y Y

AIRCRAFT E/I LOAD HELICOPTER E/I LOAD HELICOPTER MISSION REQUIREMENTS
 ITEM DESIGNATOR INDICATOR ITEM DESIGNATOR INDICATOR ALTITUDE DISTANCE PAYLOAD TEMP TIME
 C-130 B C-47 A 15000 235 15000 02 10.2
 C-141 B C-53 A 25000 500 40000 -10 15.0
 C-5 B

-- TRANSPORTED END ITEM --

SHIPPING WEIGHT EMPTY	SHIPPING WEIGHT LOADED	OPERATIONAL WEIGHT EMPTY	OPERATIONAL WEIGHT LOADED	MIL LOAD CLASS	MIL LOAD LOADED	MIL LOAD ANGLE	CREST IN	FRONT OUT	REAR IN	REAR OUT	AXLE LENGTH
3.2	6.4	5.4	6.8	06	07	15	75.8	105.8	75.8	105.8	105.8

FIGURE 57. LSA-085 Summary

TRACKED TRACKED TRACKED TRACKED TRACKED TRACKED TRACKED TRACKED TRACKED TRACKED TRACKED TRACKED TRACKED TRACKED TRACKED
GROUND PRESSURE PADS TOUCHING WHEEL WEIGHT SHOE AREA UM OF SKIDS SKID AREA UM
7.9 40 1000 3150 SI

WHEELED INFLATION WHEELED NUMBER WHEELED NUMBER WHEELED TIRE WHEELED TIRE WHEELED TIRE WHEELED TIRE WHEELED TIRE WHEELED TIRE WHEELED TIRE
PRESSURE OF PLYS OF TIRES OF TIRES LOAD RATINGS SIZE RATINGS
0 20 20 SOLID

- 1. WHEELED TIRE REQUIREMENTS:
NOT APPLICABLE.
- 2. SKID REMARKS:
NOT APPLICABLE.
- 3. TURNING INFORMATION:
TURNING RADIUS: PIVOT TURN TO INFINITE.
- 4. WHEELED AXLE AND SUSPENSION REMARKS:
AXLE AND SUSPENSION

COMBAT LOADED (FRONT TO REAR)	COMBAT LOADED (FRONT TO REAR)
LEFT	RIGHT
2205 LBS	2341 LBS
3345 LBS	3346 LBS
3129 LBS	3129 LBS
2910 LBS	2911 LBS
1932 LBS	1933 LBS
EMPTY (FRONT TO REAR)	EMPTY (FRONT TO REAR)
LEFT	RIGHT
2023 LBS	2144 LBS
3074 LBS	3075 LBS
2875 LBS	2875 LBS
2677 LBS	2678 LBS
1769 LBS	1769 LBS

- 5. TRANSPORTED OTHER EQUIPMENT:
NOT APPLICABLE.
- 6. TRANSPORTATION SHOCK VIBRATIONS REMARKS:
NOT APPLICABLE.

FIGURE 57. LSA-085 Summary - continued

7. LIFTING AND TIEDOWN REMARKS:

THE M113A3 APC (WAK) MEETS THE MINIMUM STRENGTH REQUIREMENTS OF MIL-STD-209 FOR LIFTING AND TIEDOWN PROVISIONS. WHEN FINAL CONFIGURATION OF THE M113A3 WITH ARMOR KIT INSTALLED IS ESTABLISHED, ALL LIFTING AND TIEDOWN PROVISIONS WILL HAVE TO BE REEVALUATED.

8. TRANSPORTATION PROJECTION REMARKS:

NOT APPLICABLE.

9. REGULATORY REQUIREMENTS:

NOT APPLICABLE.

10. TRANSPORTATION REMARKS:

AS SOON AS THE FINAL CONFIGURATION OF THE M113A WITH ARMOR KIT INSTALLED, WE RECOMMEND IT BE REEVALUATED.

11. SPECIAL SERVICE AND EQUIPMENT:

NOT APPLICABLE.

12. SECTIONALIZED REMARKS:

NOT APPLICABLE.

13. TRANSPORTED TO AND FROM:

NOT KNOW AT THIS TIME.

14. ENVIRONMENTAL CONSIDERATION:

NOT APPLICABLE.

15. MILITARY DISTANCE CLASSIFICATION:

NOT APPLICABLE.

16. UNUSUAL AND SPECIAL REQUIREMENTS:

NOT APPLICABLE.

17. VENTING AND PROTECTIVE CLOTHING:

NOT APPLICABLE.

18. DISASTER RESPONSE FORCE REQUIREMENTS:

NOT APPLICABLE.

EIAC ITEM NAME START LCN ALC TYPE STOP LCN UOC PCCN
 REFRIG-UNIT REFRIGERATION UNIT 0 00 P DCY A90B10

LEGEND FOR DATA ON LSA-126

+-----+
 I ITEM NAME----- NSN----- SMR--- LCN-IC I
 I PCCN-- PLISN LCN----- ALC CAL-IC I
 I REFERENCE NUMBER----- CAGE- IND-CD I
 +-----+

THE CAL-IC (CALCULATED INDENTURE CODE) IS BASED ON EITHER LCN STRUCTURE OR LCN-INDENTURE CODE (LCN-IC) WHEN THE REPORT IS SELECTED BY LCN RANGE. THE CAL-IC IS BASED ON THE PROVISIONING INDENTURE CODE (IND-CD) WHEN SELECTION IS MADE BY PCCN. THE CAL-IC IS ALWAYS USED TO POSITION THE RECORD FOR THE REPORT.

A B C D E F G H I J K L M N
 I I I I I I I I I I I I I I I I

+-----+
 I REFRIGERATION UNIT 4110-01-074-5175 PAOHH I
 I A90B10 AAAA 0 00 A I
 I F10000RG-2 94833 A I
 +-----+

I +-----+
 I I ENGINE, INTERNAL C 3420-00-126-1920 PAOFF I
 I--I A90B10 A001 006 00 B I
 I I 11898-12 44940 B I
 I +-----+

I +-----+
 I I ENGINE BLOCK 3120-00-120-3219 PAFFF I
 I--I A90B10 A002 00602 00 C I
 I I 114-109AC 44940 C I
 I +-----+

I +-----+
 I I I PISTON ASSEMBLY 3210-00-125-9873 PAOFF I
 I--I A90B10 A124 0060201 00 D I
 I I I BC1920 44940 D I
 I +-----+

I +-----+
 I I I PIN, PISTON 3120-00-678-9845 PAFZZ I
 I--I A90B10 A125 0060201AA 00 E I
 I I I 112-0069 44940 E I
 I +-----+

I +-----+
 I I I RING, RETAINING 3120-00-798-0967 PAFZZ I
 I--I A90B10 A126 0060201AB 00 E I
 I I I 112-0009 44940 E I
 I +-----+

FIGURE 58. LSA-126 Summary

PROVISIONING PARTS LIST INDEX

AIAC	ITEM NAME	START LCN	ALC TYPE	STOP LCN	UOC	PCCN	SEQ	PTD-SEL
REFRIG-UNT	REFRIGERATION UNIT	0	00	P	DCY	A90B10	REF-NO	ALL
			A	L				
			L	I				
			C	C	QPA	QPEI	UM	SMR
								E L NEXT HIGHER ASSEMBLY
								C T CAGE REFERENCE NUMBER
10855	MS18802.35	A90B10 AALD	01 D	SCREW, CAP, HEXAGON	10	26	EA	PAOZZ 3 02 44940 12190.69F
10855	MS18802.35	A90B10 ACLN	00 E	SCREW, CAP, HEXAGON	6	REF	EA	PAOZZ 3 02 32145 112-16897/E21N1
								-34-G
10855	MS18802.35	A90B10 AQLR	00 G	SCREW, CAP, HEXAGON	5	REF	EA	PAOZZ 3 02 44940 119-19875
10855	MS27183-123	A90B10 AAQN	00 E	WASHER, FLAT	8	37	EA	PAOZZ 3 02 44940 13191.98C
10855	MS27183-123	A90B10 ABYW	00 F	WASHER, FLAT	11	REF	EA	PAOZZ 3 02 11215 8N34.19
31246	ENO748EAA3412378 12-23N	A90B10 AALV	00 D	VALVE, SERVICE	1	1	EA	PAOZZ 3 04 44940 1819198-32
44282	123123123	A90B10 ALNE	00 E	CAP, TUBE	1	1	EA	PAOZZ 3 02 44940 1198-142

FIGURE 59. LSA-151 Summary

PLISN ASSIGNMENT/REASSIGNMENT

FIAC START LCN STOP LCN MODEL LCN-IC NHA PLISN PLISN
 REFRIG UNT 0 PLISN RESV PLISN REASSIGNMENT IND CODE TYPE
 0000 X AAAE

PCCN LCN STRUCTURE PTD SELECT STATUS I/O SEQ METHOD IND CODE TYPE
 AUTOPL 122221 P A

NEW RECORD DATA ON PARTS MASTER FILE OLD RECORD DATA ON PARTS MASTER FILE

REFERENCE NUMBER	CAGE	LCN	ALC	PLISN	CD	IND NHA	PRIOR ITEM	PLISN	PCCN	PLISN	CD	IND NHA	SAME AS	PRIOR ITEM	LCN	IC
F10000GR-2	64643	0	00	AAAE	A	AAAA	AAAA	AAAA01	AAAA01	AAAA	A					
F10000R-6	11599	0	01	AAAF	A	AAAB	AAAB	AAAA01	AAAA01	AAAB	A					
8742SPRTEQGRP123 45	64643	00S	00	AAAJ	B	AAAE										Y
74369	81343	001	00	AAAK	B	AAAE	AAAJ	AAAA01	AAAA01	AAAJ	B					
74817	11599	00101	00	AAAL	C	AAAK	AAAK	AAAA01	AAAA01	AAAK	C					
74643	11599	00101	01	AAAM	C	AAAK	AACZ	AAAA01	AAAA01	AACZ	C					
74639-1	11599	00102	00	AAAN	C	AAAK	AAAL	AAAA01	AAAA01	AAAL	C					
74640-2	11599	00102AA	00	AAAP	D	AAAN	AAAM	AAAA01	AAAA01	AAAM	D					
AD44BS	64643	00104	00	AAAQ	C	AAAK	AAAP	AAAA01	AAAA01	AAAP	C					
MS35489-123-1248 934	81343	00106	01	AAAR	C	AAAK	AACO	AAAA01	AAAA01	AACO	C					
53580-10-12	64643	00108	00	AAAS	C	AAAK	AAAR	AAAA01	AAAA01	AAAR	C					

FIGURE 60. LSA-152 Summary

PROVISIONING PARTS BREAKOUT SUMMARY

EIAC REFRIG-UNT	ITEM NAME REFRIGERATION UNIT 0	START LCN	ALC TYPE	STOP LCN	CTIC1 ALL	CTIC2 ALL	SRC	CAGE	REFERENCE NUMBER	PARTS BOTH
			00 P							

PART I REFERENCE NUMBER INFORMATION

REFERENCE NUMBER	CAGE	RNCC	RNVC	DAC	ITEM NAME	NSN	CTIC	PLT	AMC	AMSC	UM
CCG45/1842-11AC	51440	3	2	1	POWER SUPPLY	2805-01-108-9240	AN	02	2	N	EA

ADDITIONAL REFERENCE NUMBER(S)

CAGE	RNCC	RNVC
3417-158(C)	5	9
T38-09127/7	5	9

CTIC CAGE	CAGE NAME	UM PRICE	LOT QUANTITY FROM TO	CPC	TUC	FY
33210	ACME ELECTRONICS	327.25	1 2000	N	A	90
11215	YORK MANUFACTURING	234.91	2001 3000	N	C	90
23219	GENERAL ELECTRICAL					

PART II REFERENCE NUMBER APPLICATIONS INFORMATION

LCN	A	L	I	C	PCCN	PLISN	QPA	QPEI	SMR	EC	NEXT HIGHER ASSEMBLY CAGE REFERENCE NUMBER	TOT QTY RECOMMENDED	UOC(S)
00602	00	C	A90B10	A109	1	3	PAOFF	3	18976	18798	1	DCY, DCX	
0080102	00	E	A90B10	B024	1	REF	PAOFF	3	25597	5T23-98/12	2	DCY,	
01203	00	C	A90B10	E127	1	REF	PAOFF	3	87390	119-563290	0	DCX, DCZ	

FIGURE 61. LSA-154 Summary

RECOMMENDED SPARE PARTS LIST
 FOR SPARES ACQUISITION INTEGRATED WITH PRODUCTION (SAIP)

EIAC ITEM NAME START LCN ALC TYPE STOP LCN UOC TYPE PRICES UOC TYPE PRICES
 REFRIG-UNT REFRIGERATION UNIT 0 00 P 00 P

REFERENCE NUMBER CAGE ITEM NAME UM UM PRICE FROM TO LOT QUANTITY CPC TUC PLT
 A4622 41947 COUPLING, FEMALE EA 0.30 1 25 Y C 01
 0.28 26 150 N C

REFERENCE NUMBER APPLICATIONS

NO. LCN	ALC	MRR-1	ORR	NRTS	MAINTENANCE TASK DISTRIBUTION		TOT QUANTITY RECOMMENDED
					CBD	CAD	
001	00	0.1230	0.03	010	01	02	5
002	00	0.1439	0.05	010	00	02	4

REFERENCE NUMBER CAGE ITEM NAME UM UM PRICE FROM TO CPC TUC PLT
 142-0431 44940 CARBURETOR ASSEMBLY EA 49.56 1 500 N C 18
 46.00 501 1000 Y C
 39.95 1001 10000 N C

REFERENCE NUMBER APPLICATIONS

NO. LCN	ALC	MRR-1	ORR	NRTS	MAINTENANCE TASK DISTRIBUTION		TOT QUANTITY RECOMMENDED
					CBD	CAD	
001	00	0001.3323	0.05	010	00	05	16

REFERENCE NUMBER CAGE ITEM NAME UM UM PRICE FROM TO CPC TUC PLT
 162-1056-34 44940 CABLE, POWER, ELECT EA 122.56 1 10 N C 18
 108.00 11 50 Y C
 98.34 51 999999 N C

REFERENCE NUMBER APPLICATIONS

NO. LCN	ALC	MRR-1	ORR	NRTS	MAINTENANCE TASK DISTRIBUTION		TOT QUANTITY RECOMMENDED
					CBD	CAD	
001	00	0000.1523	0.02	001	00	03	9

FIGURE 62. LSA-155 Summary

GUIDANCE FOR ASSIGNMENT OF LOGISTIC SUPPORT ANALYSIS (LSA)
CONTROL NUMBER (LCN), ALTERNATE LCN CODE (ALC), LCN TYPE
AND USABLE ON CODE (UOC)

10. PURPOSE. This appendix provides guidance for the assignment of LCNs, ALCs, LCN-Types, and UOCs; their use; and, their relationship to one another.

10.1 Traditional LCN assignments. Traditionally, the LCN was developed using the physical hardware configuration (or engineering drawings), for LCN assignment. Using this approach, the LCNs assigned, directly tracked with provisioning documentation requirements, and enabled easy conversion to provisioning data keys (Provisioning List Item Sequence Numbers (PLISN)). Any product documentation, such as the Maintenance Allocation Chart, Maintenance Plans, or Repair Parts and Special Tools List requiring a Functional Group Code (FGC) or Work Unit Code (WUC) sequencing was selected by LCN and then resorted by the data element WUC/TM-FGC.

10.2 Functional and physical LCN assignments: a new perspective. Under the Reliability and Maintainability areas, a physical hardware breakdown may create problems in "rolling up" failure rates, reliability times, and maintainability frequencies to the appropriate higher item. For example, if an antenna connected to a wing-tip fails, the failure should be rolled to the communications system, and not to the wing structure on which it is physically attached. The traditional WUC/TM-FGC cannot be used for functional documentation since this element is used for product development and may contain a consolidated code for "like" items which will create problems for reliability/ maintainability summations and calculations. In addition, a WUC/TM-FGC cannot be documented until a physical (or traditional) LCN has already been assigned. The functional LCN will provide the flexibility necessary to correct these situations. In cases where the functional and physical breakdown are identical, separate structures will not be required. When there is a requirement for both physical and functional breakdowns, a cross-reference table mapping the functional and physical LCNs will be documented to "convert" reliability/maintainability numbers to provisioning technical factors. In an automated data processing system, the physical LCN structure should take precedence for data storage, when both a physical and functional LCN exist for the same item. Under no circumstances should it be necessary to document LSAR data under both physical and functional LCNs for the same item under analysis. By creating the physical/functional mapping, any data documented under a functional LCN will be converted from a functional to a physical key. It is important to recognize that the two structures are completely independent, and that a "mixing" of structures (part physical/part functional) for a system/end item is not permitted. Also recognize the importance of proper mapping of the functional and physical LCNs. To document functional/physical LCN assignment requires a new data element, LCN Type. This element is a key and is required where all LCN oriented data resides. The LCN-Type is a one-position code of either "F", Functional; or "P", Physical.

20. LCN ASSIGNMENT. The LCN may represent either a functional or hardware generation breakdown/disassembly sequence of system/equipment hardware including support equipment, training equipment, and installation (connecting) hardware. As such, the LCN is a key field utilized to input data into the LSAR data system and to extract reports from the data system. Normally,

development of the LCN structure and assignment of LCNs through the subsystem level should be accomplished prior to completion of the first LSAR data tables. Extreme care should be exercised in developing the structure, so that the least number of characters is used for each indenture level. This can be accomplished by identifying the maximum number of parts/assemblies which will be assigned a unique LCN at each indenture level. If the maximum number of items at a given indenture level is less than or equal to 36, then 1 alphanumeric character would suffice. If the maximum number of items is greater than 36 but less than or equal to 1296, then 2 alphanumeric characters would suffice and so on. No more than one position of the LCN should be used to identify the system. It is useful to develop an LCN structure for the entire system/equipment hardware. Care should be exercised in assigning the LCNs, since the order in which they are assigned will affect the order of Failure Modes, Effects and Criticality Analysis (FMECA) data and task analysis information, and may affect the order in which it will be used on a repair parts lists and assignment of PLISNs. For example, if it is a requirement for attaching hardware to appear on a repair parts list prior to the assembly, these items would have to be assigned LCNs which are less in value than the one assigned to the assembly. In assigning the LCN early in the design of an end item, it is also advantageous to skip one or two LCNs, so that an additional item can be inserted later on due to design changes. This advance planning avoids the possibility of having to resequence at a later point in the program. The above guidance should be considered prior to assigning the LCNs. In addition, three basic methods for assigning LCNs are provided below.

20.1 Classical LCN assignment. This method dictates assignment of a unique LCN to every application of a part numbered item in the system including piece parts. This method ensures proper identification of an item to its Next Higher Assembly (NHA) and ensures proper roll-up/summarization of data for all LSA Record (LSAR) reports. Figure 63 is an example of the classical LCN assignment method. From a provisioning standpoint, use of the classical assignment method would allow the automatic assignment of PLISN, NHA PLISN, SAME AS PLISN, and Indenture Code.

20.2 Modified classical assignment method. This method is a variation of the classical assignment method, which permits piece parts to be assigned the same LCN at the indenture level below the component/assembly of which they are a part. In addition, attaching hardware may be assigned the same LCN at the same indenture level at which the assembly is located. The assembly to which the attaching hardware is required is provided a separate LCN. Figure 64 shows an example of the modified classical method. The items with an asterisk have been assigned the same LCN. Application of this method could economize the number of LCNs required at the lower indenture levels. Use of this method ensures proper roll-up/summarization of data for all LSAR reports. From a provisioning standpoint when hardware breakdown approach is used for the LCN, this method allows the automatic assignment of all PLISNs and the indenture code.

20.3 Sequential assignment method. For large systems, an attempt to use any of the above methods can still result in a need for more than the 18 characters allocated to the LCN field. In this situation, the classical or modified classical assignment method would be employed for the first 12 or 13 characters of the LCN field; the last five or six characters of the LCN field would be assigned sequentially through the remaining indentures. An example of the sequential assignment method is provided on figure 65. This method

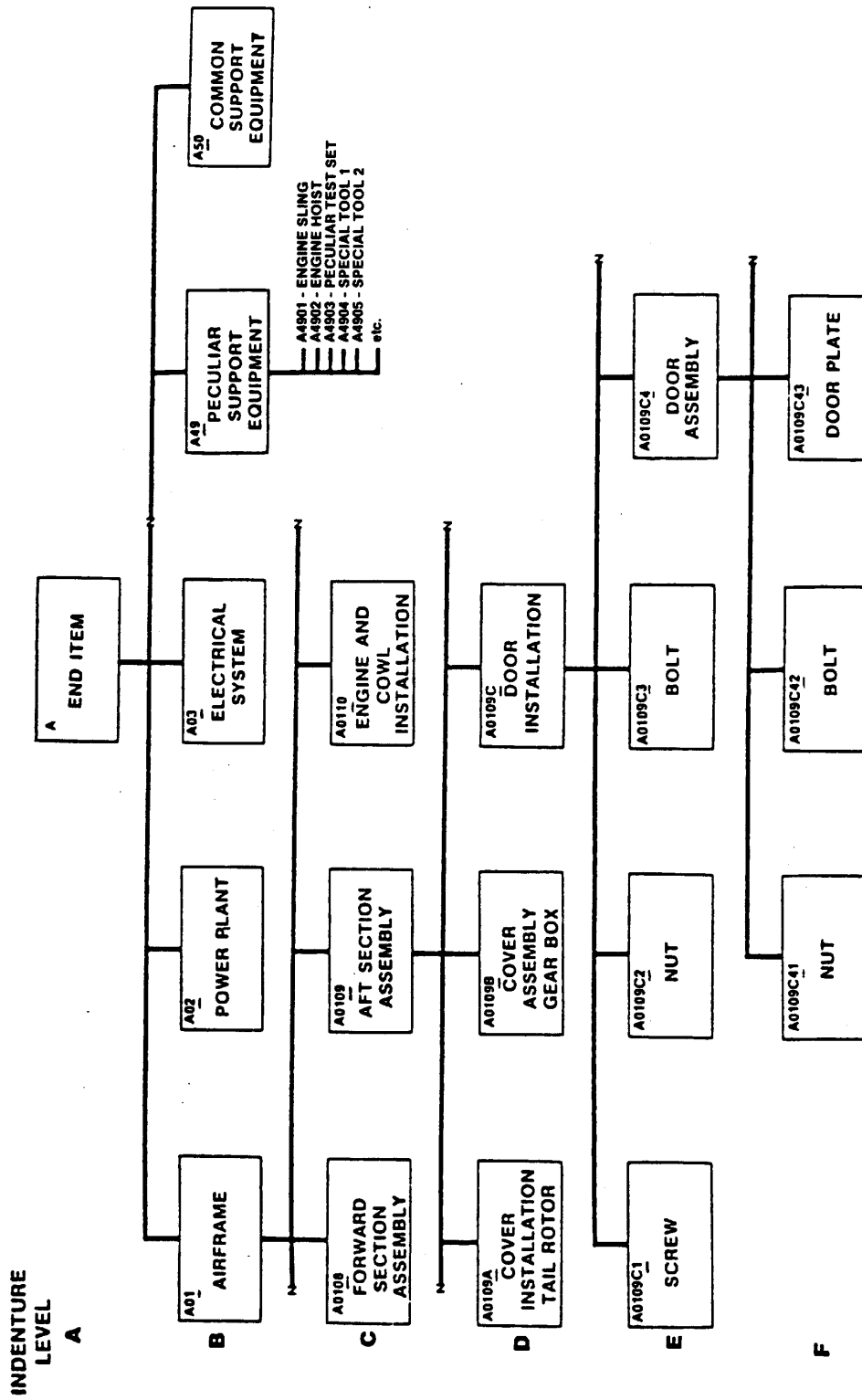

FIGURE 63. Classical LCN assignment method.

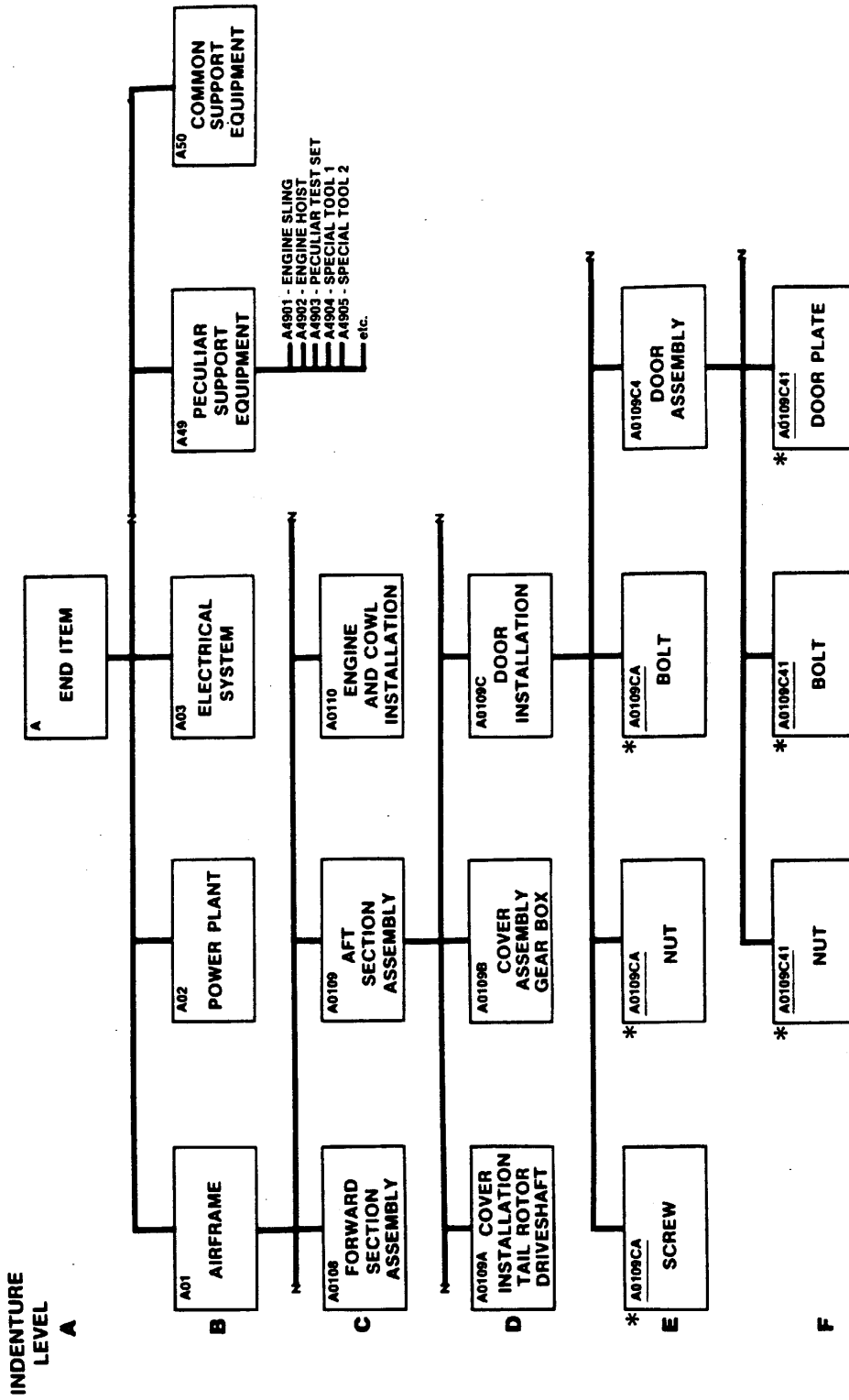

FIGURE 64. Modified classical LCN assignment method.

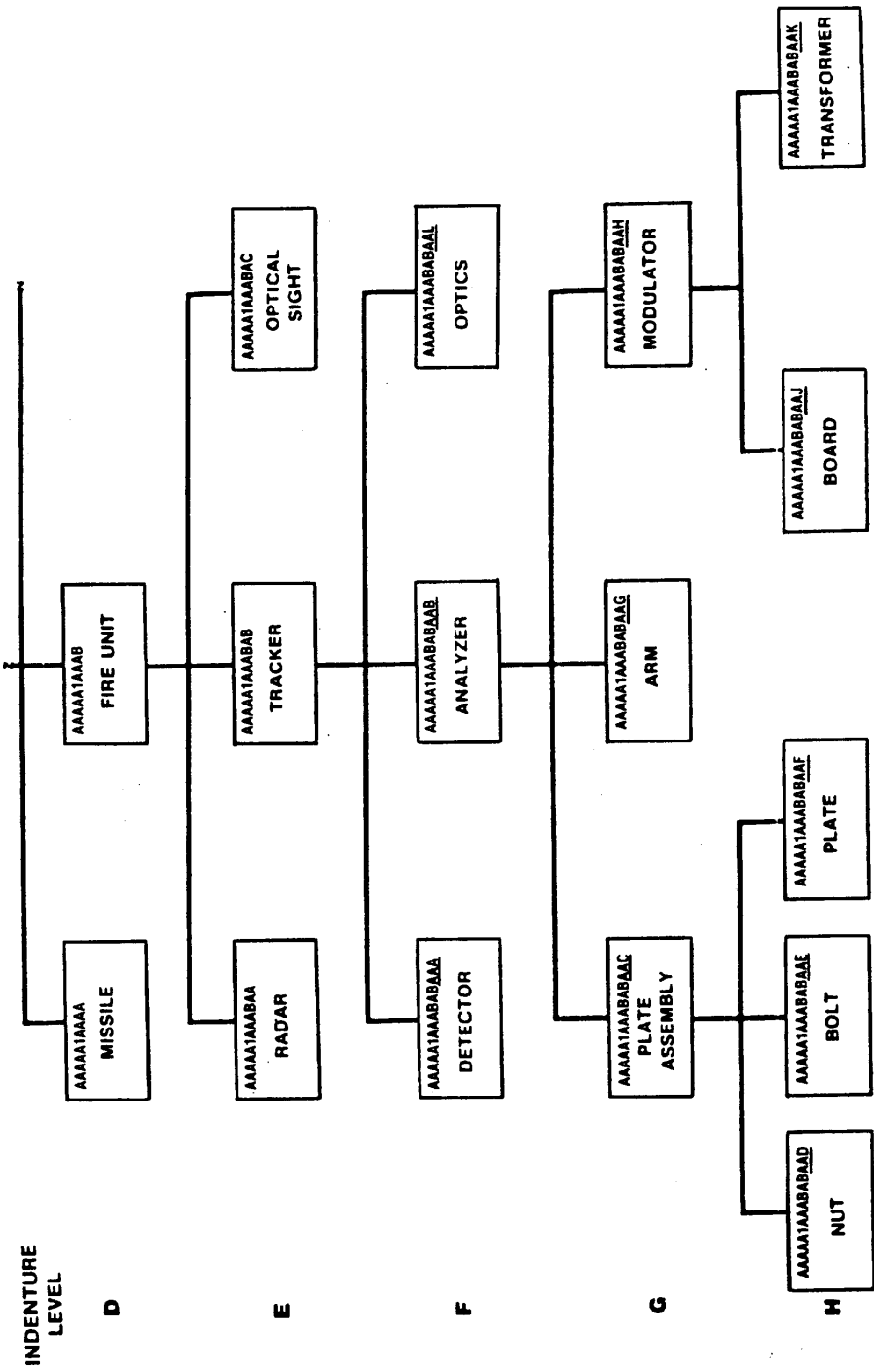

FIGURE 65. Sequential LCN assignment method.

does not affect the normal processing of the LSAR output reports; however, it is necessary to select reports at indenture levels above the point where sequential assignment of LCNs was initiated. From a provisioning standpoint, this method dictates manual input of the LCN-indenture code (LCN-IC) in order to automatically assign PLISN, NHA PLISN, and Indenture Code.

30. ALTERNATE LCN CODE (ALC). The ALC (codes 00 through 99 and space) provides the capability to document alternate design concepts or like items for different models using identical LCNs at the same system breakdown level. As such, ALC is a key data element and a value of 00 is considered just as significant as a value of 01, 10, or 23. In fact, all LCNs which have a corresponding ALC with a value of 00 represent the "basic system" hardware. The ALC is LCN oriented and is used to aid in the documentation of the following:

a. Alternate items with different reference numbers (e.g., diesel engine versus gas engine), one of which will be selected for production.

b. Different reference numbered items which are used in the same functional and physical location (i.e., same LCN) in the hardware breakdown, and the usage of either item results in a different configuration/model designation (i.e., different UOCs).

The use of ALC for a single configuration/model is discussed in the immediately following paragraphs, while ALC usage for multiple configurations/models is discussed in paragraph 50.

30.1 ALC usage for a single configuration/model. A system/end item which has a single configuration/model designation will have only one assigned UOC. When a system/end item has a single UOC, then the ALC can be used to capture analysis data for alternative designs or maintenance concepts. To properly input LSAR data and establish a traceable LCN breakdown structure, the following rules should be adhered to:

a. Rule 1. The "basic system" hardware breakdown must be input using ALC values of 00. This is necessary since the selection process will always default to the "basic system" data, if alternative data has not been entered.

b. Rule 2. Alternative designs would be broken down completely in terms of LCN and associated data.

c. Rule 3. To the maximum extent possible, the ALC assigned should be the same value throughout the alternative design/maintenance concept.

Following these rules allows for an orderly buildup of LSAR data and avoids confusion concerning which items may be common to two or more alternatives and provides for easier retrieval of LSAR reports.

30.1.1 Figure 66 is an example of a single configuration/model end item with a UOC of "ABC". The example also represents how the ALC can be used for alternative hardware design concepts. Three different fuel pumps are being considered for use on the gas engine, as well as an alternative diesel engine. All "basic" hardware items have an ALC of 00, while two additional fuel pumps and the entire diesel engine breakdown have different ALCs. This is in accordance with the first rule stated above.

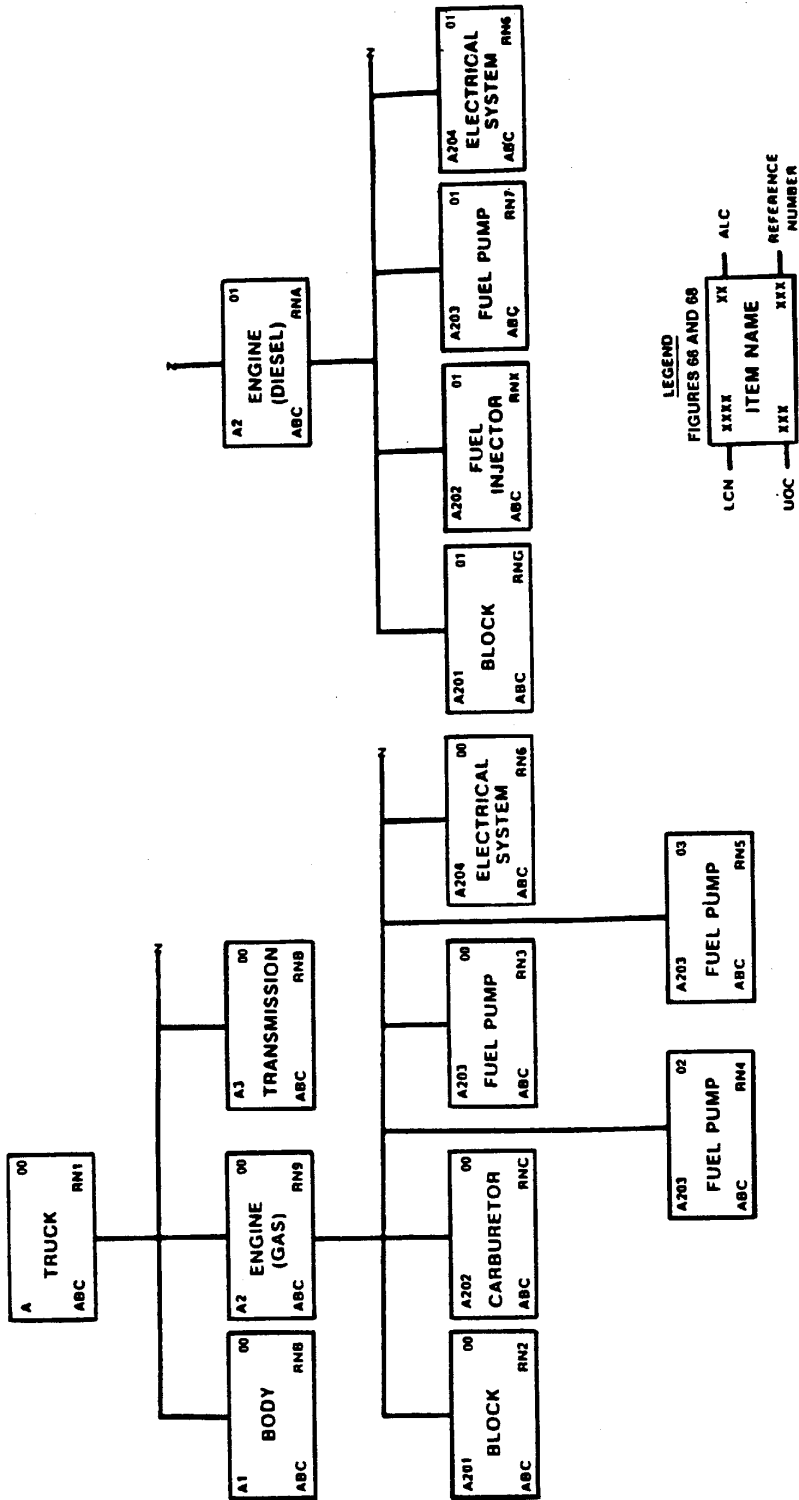

FIGURE 66. Alternate LCN code usage.

30.1.2 Rule 2 is also followed for the figure 66 breakdown of the diesel engine because the identical electrical system was repeated from the gas engine. Rule 3 is followed in assignment of ALCs for the diesel engine.

30.2 ALC usage for LSAR reports. For most report selections, the UOC is always the first criteria that must be met for data selection and LCN is the second criteria. ALC becomes the third select criteria, if the user specifies a specific ALC value on the report request. As already discussed, an ALC of 00 on the report submittal will result in choosing "basic system" LCN data (i.e., records with 00 ALCs). If an ALC is requested with a specific numeric value, only items with a matching ALC will be chosen.

30.3 Lower-tiered LCN/ALC selections. In addition to the basic report request, different LCN and ALC combinations at a lower indenture level from the basic report selection may be chosen to specify the alternative design desired by identifying these LCNs and ALCs. This is necessary when rule 3, discussed in paragraph 30.1, cannot be strictly adhered to and designation of the ALC on the basic report request will not result in a complete substitution of the alternative design. This situation will occur when alternative designs are being considered within the hardware breakdown of another alternative design. The example on figure 66 displays this situation; alternative fuel pumps are being considered within the gas engine and two alternative engines are being considered. Thus, in order to obtain the "basic system" (i.e., with gas engine, but with fuel pump RN5), a lower-tiered LCN/ALC request selection must be input with an LCN of "A203" and an ALC of "03". The basic report request would have an ALC value of 00. In order to produce a report for the "basic system" with the diesel engine substituted, the following selection request would be required:

a. A basic selection request with an LCN of "A", UOC of "ABC", and an ALC of "00". This produces a report of the "basic" truck.

b. A lower-tiered LCN/ALC selection request with an LCN of "A2" and an ALC value of "01". This information would modify the basic selection request to choose the diesel engine, in lieu of the gas engine.

The lower-tiered LCN/ALC selection request allows the user to create many different variations of a system/end item via the LSAR reports. While use of the ALC for alternative designs does not reduce the amount of data required (i.e., rule 2 of paragraph 30.1), it does provide for easier data storage and report generation.

40. LOGISTIC SUPPORT ANALYSIS CONTROL NUMBER TYPE (LCN-TYPE). The LCN-TYPE is a one-position code used to indicate whether the associated LCN represents a functional versus physical or hardware generation breakdown structure. Generally, top-down FMECA documentation and selective task analysis, e.g., fault locations, "track" to a functional breakdown. Other documentation requirements, e.g., provisioning, track to a system/equipment hardware breakdown. An example of a functional and physical breakdown for the same system/equipment is shown on figure 67.

50. USABLE ON CODE (UOC). The UOC is used to identify the model/configuration relationship of each LCN comprising a system/equipment and to control these relationships for LSAR report generation. The UOC is a critical data element and should therefore be used when establishing an LSAR. This

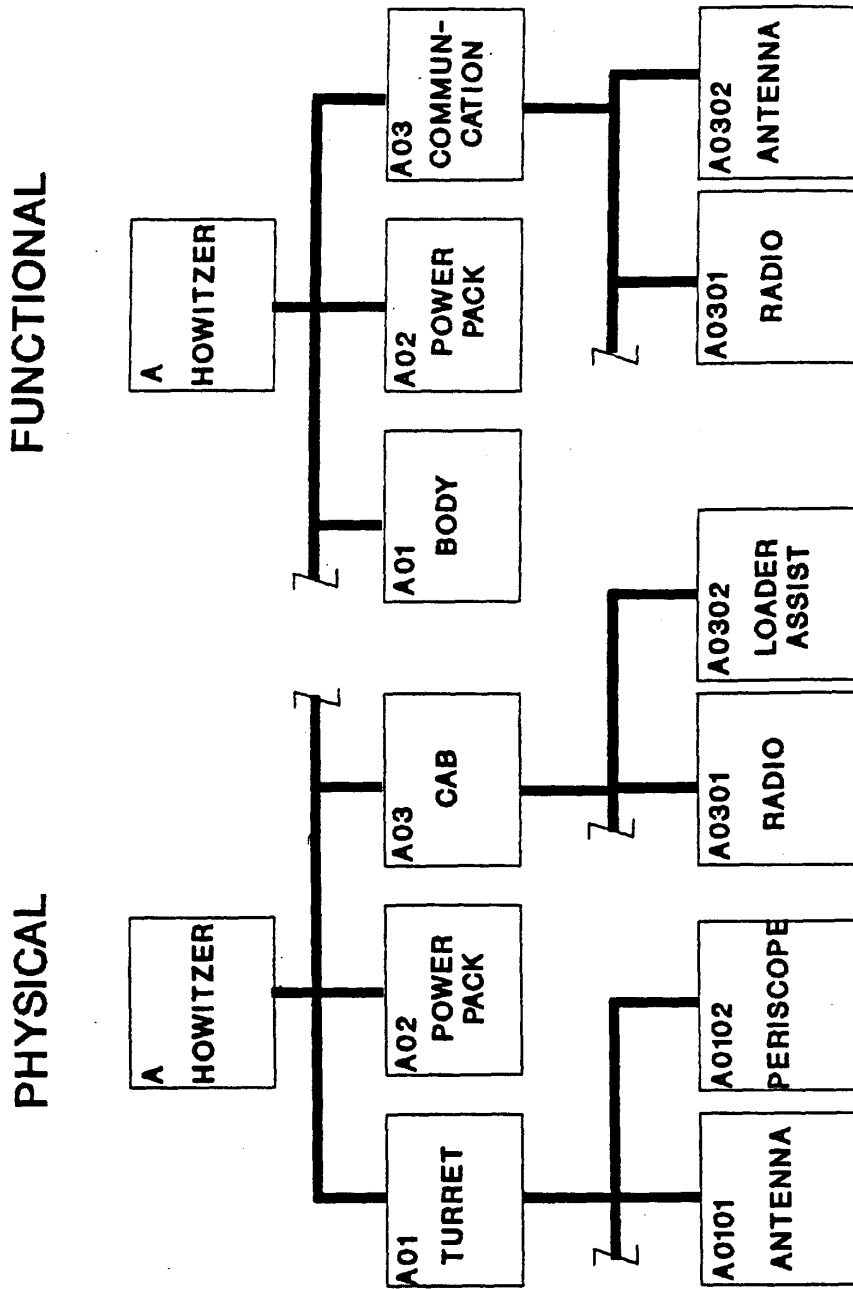

FIGURE 67. Functional vs. physical LCN assignment.

requirement holds even if only one configuration/model of a system/equipment is being documented. In accordance with table XC, contained in appendix A of this standard, each configuration/model is assigned a unique UOC at the system/end item level LCN. Each individual assembly/component/piece part is also "linked" to the assigned UOC of the model of which it is applicable through tables XF and HO. When an assembly/component/piece part is applicable to more than one configuration/model, then multiple UOCs are "linked" to the component for a single LCN and ALC via tables XF and HO. This eliminates the requirement of duplicating analysis and related data, merely because an item has application to multiple configurations/models. It should be stressed that if an item's usage for a given configuration model differs from another configuration/model in terms of quantity, Source, Maintenance, Recoverability (SMR) coding or analysis data, then multiple UOCs should not be used for a single LCN. This situation dictates input of additional relational table rows using the ALC to indicate different data for the same LCN and a different UOC.

50.1 ALC and UOC relationship. In order to document multiple configurations/models in the LSAR, the ALC plays an important role. As already stated, for items that are common to all configurations/models, only one LCN entry is required for the multiple UOCs. In addition, since such an item is considered part of the "basic system", its ALC would be 00. For those items that bring about a configuration/model change, the ALC is used in a manner similar to that discussed in paragraph 30 of this appendix. Figure 68 is an example of multiple UOCs for a given system/end item and the usage of ALC in conjunction with multiple model items. In the example, the basic model truck has a UOC of "ABC", while the new model truck has a UOC of "ABD". The reason for the additional model is the use of a diesel engine, instead of the gas engine. Since both types of engines physically and functionally appear in the same location of the truck breakdown, their LCNs are the same. The ALC of "01" has been used to differentiate new reference numbered items from the basic items.

50.2 UOC and ALC usage for LSAR reports. Paragraph 30.2 of this appendix stated that most selection requests for the LSAR reports must have, as a minimum, LCN and UOC on the request. The reason for this is that UOC is the overall report generation key that must match to a record before LCN and ALC are considered. In the case of a single configuration/model, its importance is reduced since every item has the same UOC value. For multiple configurations/models, the identification of the desired UOC on the selection request will result in building the desired output LSAR reports without lower-tiered LCN/ALC selections and without knowing which ALC values were used for that UOC's LCNs. Using the example on figure 68, a report selection request with an LCN of "A", an ALC of 00, and a UOC of "ABC" will result in the basic model breakdown being output. This means that the fuel pump, with reference number RN7, would be chosen over the other two fuel pumps. If the report selection request had been LCN of "A", a blank ALC, and UOC of "ABC", all items containing the UOC "ABC" would be selected. Therefore, all three fuel pumps under the basic model would be output. If the second model of the truck with UOC of "ABD" is to be selected, a report selection request with an LCN of "A" and a UOC of "ABD" is all that is needed. This would result in all LCN items with UOC values of "ABC" and "ABD", as well as all LCN items with UOC of "ABD" only being selected. In effect, the basic model with the diesel engine substituted would be output for the desired reports.

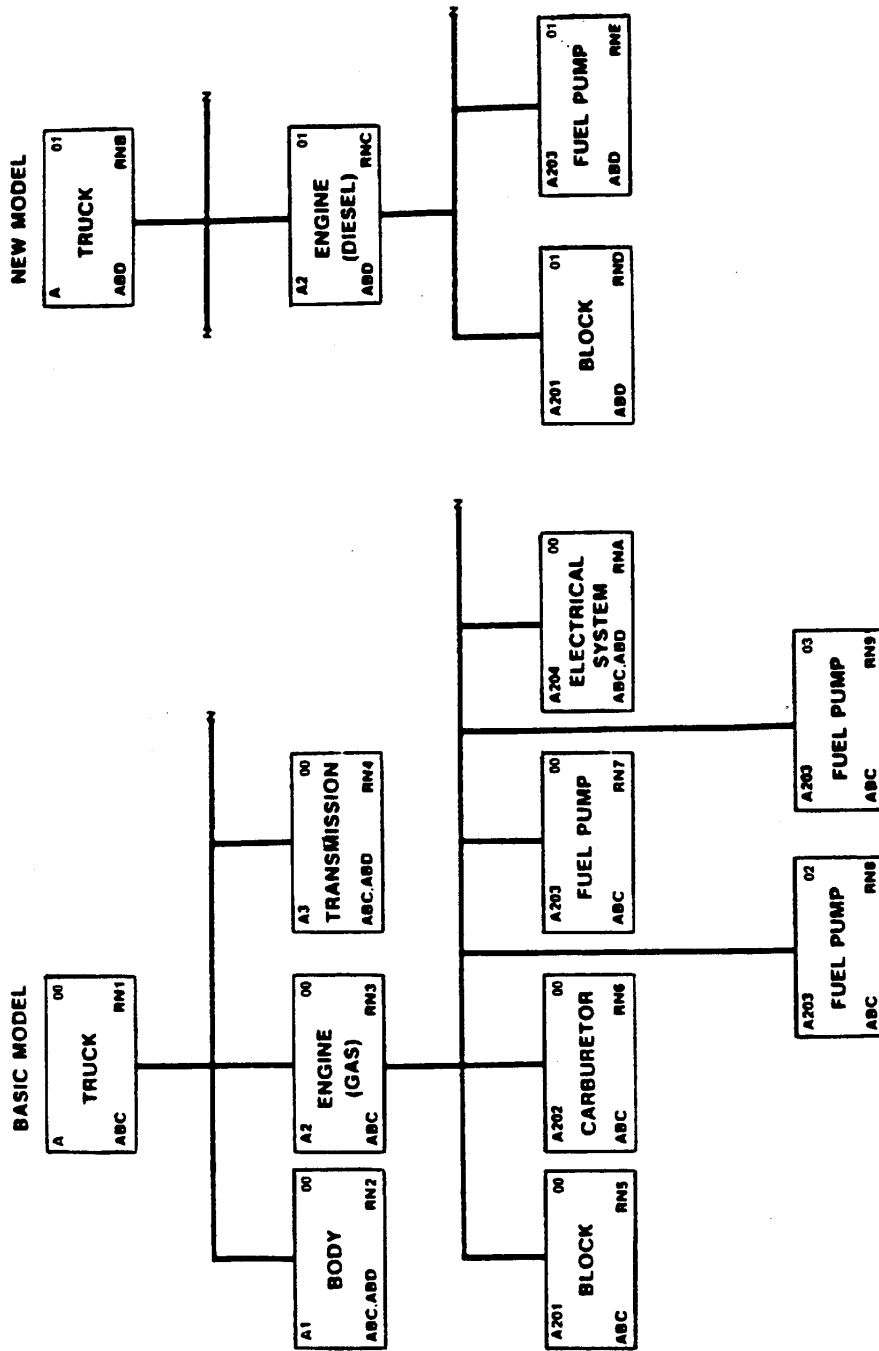

FIGURE 68. Usable on code and alternate LCN code usage.

60. SERIAL NUMBER CONTROL AS AN ALTERNATIVE FOR CONFIGURATION MANAGEMENT.

For complex or major weapon systems in various production stages, the use of serial numbers may be used for greater control of end item configuration. By documenting Serial Number applicability in tables XD, and assembly/component/piece part relationships to the serial numbered end item(s) using tables XE and HN, configuration control may be maintained to the individual end item. This is beneficial when production changes may occur to individual end items, which may not warrant an official configuration/model designation change. The LSAR summaries do not use serial number as a selection criteria, but ad hoc query capability would allow analysis/summary report generation based on serial number qualification.

70. SUMMARY. The assignment of LCNs, UOCs, and ALCs must be approached carefully and logically in order to ensure that the LSAR reports represent the hardware logistics data desired. In general, a system/end item development effort normally begins with a single model designation (i.e., one UOC). During this phase of development, the ALC is needed only when alternative designs are being considered. As the hardware design stabilizes, the "undesirable" alternatives are deleted from the LSAR database in favor of "basic system" configuration. Once a system/end item enters the production phase, engineering change proposals, because of producibility limitations, design deficiencies, or changes in operational requirements, can dictate a new configuration model. When this occurs, the ALC once again would be used to aid in the documentation effort. This orderly application of the ALC to alternative design/maintenance concepts or multiple configuration/models can preclude user confusion. It is possible that some system/end item developments will initially be faced with documenting multiple configurations/models and alternative design/maintenance concepts, simultaneously. When this occurs, an orderly and logical approach to UOC and ALC, following the guidance of this appendix, will result in a properly documented system/end item.

APPENDIX D

APPLICATION AND TAILORING GUIDANCE
FOR THE LOGISTIC SUPPORT ANALYSIS (LSA) RECORD (LSAR)

10. GENERAL.

10.1 Purpose. The LSA process associated with a materiel acquisition program is iterative in nature. The LSAR provides a structured, standardized, yet flexible approach to the documentation and use of the data required to effectively accomplish contractually invoked LSA tasks. To be effective, LSA documentation must be initiated early in the acquisition life cycle, must be updated to reflect changes in the hardware design and support concept, and must be tailored to be commensurate with individual program requirements, constraints, and characteristics. The LSAR data is generated as a result of the performance of LSA tasks. Tailoring of both the LSA tasks to be performed, and the resultant LSAR data produced as a part of LSA task documentation, is mandatory. Limitations on system development funding make it imperative that LSA be applied judiciously to improve hardware design and support concepts, not merely to collect LSAR data. This appendix provides guidance for appropriate application of the LSAR during each phase of a system's life cycle and the procedures for tailoring of the LSAR data records, elements, and standard reports to satisfy program requirements at minimum cost. This appendix does not contain any requirements and is not to be implemented in contractual documents. The user of this appendix may be a Department of Defense contracting activity, government in-house activity, prime contractor, or subcontractor wishing to impose LSAR requirements.

10.2 How to Use this appendix. Tailoring of the LSAR requirement begins with the identification of the life cycle phase of the system/equipment acquisition effort. Paragraph 20 of this appendix addresses the applicability of the LSAR for each of the life cycle phases. Figure 69 depicts general applicability of the LSAR data tables to the system/hardware breakdown. Once the life cycle phase has been established, tailoring of the LSAR requirement can be performed. Paragraph 30 provides a stepwise procedure for tailoring the LSAR, based upon MIL-STD-1388-1 tasks and subtasks, related engineering and Integrated Logistic Support (ILS) element analysis efforts which result in LSAR data, and deliverable logistic products specified by data item descriptions (DID) to be included in the contract. The result of this tailoring process is a completed DD Form 1949-3, LSAR data requirements form, identifying the LSAR data table and data element requirements for the specific phase of the acquisition effort (see figure 71). Guidance for determining LSAR completion schedules is contained in paragraph 40. The final step in tailoring the LSAR effort involves contractual delivery of the LSAR data itself. Paragraph 50 discusses alternatives for delivery of the LSAR data.

20. LSAR APPLICATION AND USE BY LIFE CYCLE PHASE.

20.1 LSA process. The LSA process is applicable to all phases of the life cycle and all types of acquisition efforts. Tailoring of the LSA tasks, and additionally, tailoring of the LSAR documentation requirements are dependent upon the life cycle phase, type of acquisition, and degree of program control desired. In relation to the acquisition life cycle, the LSA process can be divided into two basic categories: (a) LSA encompassing laboratory research

and development (R&D), preconceptual and conceptual studies, and development of conceptual designs; and, (b) LSA for Design Development (DD) to include late R&D and the demonstration/validation through deployment phases. Both categories of LSA have as a primary objective:

a. Influence of design concepts and hardware design to reduce operating and support costs and increase readiness and sustainability.

b. Identification of support resource requirements progressively and concurrently with the hardware design.

20.2 Concept exploration and definition (CE) phase. LSA is initiated in the earliest studies and design efforts and continued during all phases of the materiel development and acquisition program. Initially, the LSA is primarily directed toward establishing support related factors and constraints, which must be used in developing design guidelines and trade study plans. Initial LSA is also directed toward identifying targets of improvement; of objectives or goals for reliability, availability, maintainability, and life cycle cost (LCC); potential logistics problems, constraints and risks; and, the projection of logistics resource requirements and costs. During this effort, the LSA program continually interfaces with other system engineering programs through historical data reviews, tradeoff analyses, use studies, design projections, and other LSA tasks to arrive at the most cost-effective materiel design concept(s) and acquisition plan(s) for further examination, study, and development. In fact, LSA task 301 accomplishment produces a task inventory that can be used by all engineering specialties. The results of the LSA effort are embodied in the program documents and supplemental technical reports. These are required in the materiel acquisition decision process prior to entry into the demonstration and validation phase. The limited volume of LSAR data is usually produced by the requiring authority to define and document system level requirements. Figure 70 suggests the LSAR data which might be generated at this time. However, tailoring LSAR data requirements is mandatory, and not all of these elements may be required to support LSA objectives.

20.3 Demonstration and validation (DVAL) phase. For most development programs, the second category of the LSA effort begins with this phase. The data elements completed within each table are dependent upon the analysis tasks specified and the DIDs placed on contract (these aspects are covered in paragraph 30 of this appendix). Because of the LSA efforts in the earlier phase, the requiring authority is more aware of system requirements and possible shortfalls and can better monitor subsequent performing activity system development. With this awareness of the system, the requiring authority can require the performing activity to justify any deviations or changes in the original concept. To more fully utilize the LSAR documentation previously developed, contracts should specify that repair and support requirements be documented for all maintenance levels down to major subsystems. This data can be used to verify data derived for lower assemblies/parts, and conversely, for the system and major subsystems.

20.3.1 During the DVAL phase, the LSA is directed toward: (a) influencing the materiel design by refining and updating support related design guidelines, and by challenging design characteristics which impose unnecessary or costly support requirements; and, (b) updating and refining logistics support planning data developed during the preconcept and concept phase. LSA

documentation during this phase should provide the data to help further define support concepts, cost estimates, potential logistics problem areas, technological advances, or additional design improvements and test requirements.

20.4 Engineering and manufacturing deployment phase. During this phase, the LSAR effort is a continuation of the effort conducted during the DVAL phase. The LSAR data tables are completed to the hardware indenture level identified on figure 69, and the resulting data is used to develop logistics support requirements for testing, deployment, and operation.

20.5 Production and deployment phase. The LSAR data established during the development phases is retained during this phase to support the logistics analyses that occur as a result of engineering design changes. In addition, the data is used to evaluate the system's performance after it is deployed to determine the impact of future equipment modifications or support requirements. The LSAR data would be used to establish design changes, goals, and requirements for succeeding generations of materiel acquisitions.

30. TAILORING LSAR REQUIREMENTS. The extent, and consequently the cost, of LSAR inputs and outputs required to document and support the analyses of LSA tasks will vary from program to program. These variations are attributable to such factors as: the degree of LSA program visibility and control desired by the requiring authority; life cycle phase; hardware complexity; and, the specific acquisition program characteristics (e.g., new development, major modification, nondevelopmental). In addition, the data requirements identified in this standard have been designed to accommodate the documentation and data manipulation to support Army, Air Force, Navy, and Marine Corps requirements. Each service has expressed requirements for unique capabilities not generally applicable to the other services. For the above reasons, the blanket purchase of the LSAR data elements and reports is an ineffective and costly approach to the utilization of the LSAR. To realize maximum benefit from the application of the LSAR, it is imperative that extreme care be exercised in the contractual imposition of the LSAR requirements is not only concerned with the exclusion of unnecessary data requirements, but also, and just as important, with the identification of all requirements which will eventually be needed to support a specific LSA program effort. Failure to adequately identify data requirements can be just as costly as the over purchase of data. To that end, each functional and engineering specialty area must play in the tailoring of the LSAR, including manpower and human factors engineering personnel. The guidance contained in the following sections of this appendix have been arranged in a logical, stepwise sequence to assist in the optimum selection of LSAR features.

30.1 LSA task selection. The initial step in tailoring of the LSA data requirements involves selection of the analyses tasks described in MIL-STD-1388-1, which are to be accomplished. Detailed guidance for task and subtask selection, with respect to acquisition program characteristics, program phase, and information requirements associated with primary system developmental milestones, is provided in appendix A of MIL-STD-1388-1. Selection of some LSA tasks will result in data which is documented directly into the LSAR. Output from other tasks becomes the input to follow-on analyses, and as such, relates only indirectly to the LSAR documentation. Table II provides a list of the LSA tasks and subtasks which relate directly to the LSAR data tables. A review of each data table is mandatory to ensure

that only those data elements required to document the tasks are procured. Once established, the specific data elements required to document the tasks should be recorded on DD Form 1949-3 (see figure 71).

30.2 Interfacing and coordination with other program elements. Data required to conduct an effective LSA program may also be developed as a result of analyses conducted in support of associated program elements such as:

- a. System/equipment design program
- b. System/equipment reliability program
- c. System/equipment maintainability program
- d. Human engineering program
- e. Standardization program
- f. Parts control program
- g. System safety program
- h. Packaging, handling, storage, and transportability program
- i. Initial provisioning program
- j. System/equipment testability program
- k. Survivability program
- l. Technical publications program
- m. Training and training equipment program
- n. Facilities program
- o. Support equipment program
- p. Test and evaluation program
- q. LCC program

It is essential that coordination and interfacing of engineering disciplines and ILS functional elements be affected to maximize the usage of data developed by each program element, thereby, realizing analysis economics and avoiding the generation of incompatible ILS products. Effective coordination with related program elements can produce benefits by eliminating costly duplications of effort.

30.2.1 Identification of the engineering and ILS functional element requirements which interface with the LSA process, and which generate LSAR data, is the next consideration in the tailoring process. Results of analyses from other program elements can be used as source data for LSA tasks and vice versa. For example, inputs from the design, reliability, maintainability, human engineering, safety, and other program elements may be required to

satisfy the requirements of task 401, Task Analysis, as described in MIL-STD-1388-1. Benefits of effective interfacing and coordination may also be achieved by utilizing the features of the LSAR to record, store, and manipulate data in support of requirements levied by other program elements. As an example, the LSAR data tables can be used to produce the LSA-018, Task Inventory report. This report is used and reviewed by human systems integration specialists, as well as the LSA program.

30.2.2 Once the related program elements have been established, the next step in the tailoring process is the identification of the logistics DIDs associated with each element of ILS that will be placed on contract. A detailed review of the DIDs is required to determine the specific data element requirements of each. Table III provides a listing of the commonly cited DID's associated with each element of ILS that can be satisfied by the LSAR data. This listing is not intended to be inclusive of all logistic related DIDs and the user is encouraged to apply the same logic in table III to other DID's not listed which may be partially satisfied using the LSAR. The objectives and use of each DID are summarized in table III, along with a description of the extent of interface with the LSAR data tables and LSAR reports. The user of this appendix should use table III to determine the extent to which the LSAR data can be used to satisfy the logistics DIDs that will be placed on contract. If LSAR reports can be used to satisfy a DID, then the specific LSAR data elements can be established by using appendix B, figure 14, LSAR Input to Report Matrix. This matrix identifies all of the LSAR reports and the input data elements required to generate each (e.g., DI-ILSS-81140A, Maintenance Allocation Chart (MAC), can be satisfied by using the LSA-004 report). Finding this report across the top of figure 14 and then reading down the column will provide the user with the specific data elements and LSAR data tables required to produce the report. This process would be repeated for each DID identified. This information would then be input on DD Form 1949-3, in order to establish the total LSAR data requirements from both an analysis and a logistics data product standpoint.

40. SCHEDULING OF THE LSAR DATA. This paragraph addresses scheduling the development of the LSAR data, so that it can be used in a timely manner as source data for the development of the contractually cited logistics products discussed in paragraph 30. This guidance is applicable to any type of development effort and any phase of the life cycle. To establish timely completion of the LSAR data, the user must first establish the scheduled completion dates for the data products that utilize LSAR data. Required delivery dates for the products specified by DIDs should be established in conjunction with preparation of the solicitation package, and should take into account the significant milestones of the development effort.

40.1 Once the scheduled completion dates for all chosen DIDs have been established, the user can determine the required completion scheduled for the LSAR. Figure 14 provides a cross-reference list of the LSAR data elements and the reports that use the data elements on a given data table for product development. Since the table is sequenced by data table, the completion date of each data table can be established by listing the delivery dates on the DIDs and then choosing the earliest date as the scheduled completion date for that LSAR data table. This approach must be tempered by the range of data elements on a data table that are required as source data for development of a DID product. For example, the scheduled delivery date for DI-ILSS-81285, Long Lead Time Items List, may be 120 days after contract award, while the delivery

date of DI-ILSS-81285, Provisioning Parts List, is 24 months after contract award. This does not mean that all data tables related to support item identification and application are to be completed 120 days after contract award, but rather, specific data elements for parts with certain production lead times would be completed on data tables of support items to satisfy DI-ILSS-81285, Long Lead Times Item List.

40.2 Completion dates for the LSAR reports can be established by using the required delivery dates of the DIDs that use the given report for product development. Additionally, the scheduled completion date for the LSAR data tables, to include the specific data elements required to produce an LSAR report, can be established by using figure 14. For example, if DI-ILSS-81140A, MAC, had a required delivery date of 18 months after award of contract, then the LSAR output report, LSA-004, must be available at that point for product development. Additionally, by using figure 14, it can be established that specific data elements on the listed data tables must be completed for product development of DI-ILSS-81140A (and report LSA-004).

40.3 This approach to scheduling completion of the LSAR data must take into account interim product delivery dates, final product delivery dates, and scheduled updates to final products. Each of these dates will impact the range of LSAR data required, depth of data required (i.e., the hardware indenture levels and maintenance levels specified), and the number of updates to the LSAR data required. The LSAR completion schedule must then be coordinated with related program schedules (i.e., drawing release) to ensure availability of data for LSAR development. Finally, by establishing an LSAR completion schedule which is timely for DID product development, the user now has the additional option of not requiring delivery of LSAR data as a separate data item. In effect, completion of a deliverable product is intimately tied to the LSAR data and quality.

50. ALTERNATIVES FOR DATA DELIVERY. The last step in the LSAR data tailoring process involves delivery of the LSAR data itself. LSAR data can be delivered in manual form, LSAR reports, LSAR data table files, or through interactive access to a contractor LSA database. The use of a manual LSAR data file is generally applicable to simple hardware systems, limited report requirements, infrequent use of the data, and uncomplicated reports. Implementation of an automated LSAR is generally applicable to a complex hardware system, multiple and varied applications, ability to produce tailored reports, on demand use with short response time, and the ability to manipulate the LSAR data for specialized reports.

50.1 An automated LSAR presents the additional decision option of who will be made responsible for Automated Data Processing (ADP) of the LSAR data. Normally, the performing activity would be responsible for data processing, using a validated independently developed LSAR software system. The alternative to this is to use the in-house ADP capabilities of the requiring authority, thus requiring only a data entry effort by the performing activity. Once the decision is made who will be responsible for automated processing of LSAR data, the media for delivery can be established.

50.2 Delivery of the LSAR reports contained in appendix B is one option for delivery of data in an automated LSAR environment. The LSAR reports are intended to satisfy the delivery requirements of specific logistics products (e.g., MAC, Maintenance Plan, Support Equipment Recommendation Data, etc.).

As such, the LSAR reports are static presentations of LSAR data and cannot be updated or processed further after delivery. They offer the least flexibility for LSAR data use from an automated standpoint. Requiring LSAR reports as deliverables is appropriate for final product delivery, or when no further processing capability is available or necessary.

50.3 Delivery of the LSAR relational tables via magnetic tape/disc/drum is another option for delivery of data in an automated environment. This option also includes the delivery of LSAR data files that require processing from the LSAR relational tables (such as input files for provisioning, Defense Logistics Information Systems screening, or packaging system data). An internal processing capability is required for each LSAR data file procured by the requiring authority. Delivery of the LSAR relational tables provides the capability to subsequently produce any of the LSAR reports, other data files, and to produce ad hoc reports via the query capability of a validated LSAR Relational ADP system. Separate delivery of the LSAR data files places the responsibility for their generation with the performing activity rather than the requiring authority. Because of the flexibility provided by these processable data files, they can be used to satisfy both interim and final LSAR delivery requirements. Periodic delivery can reduce time spent for onsite data reviews by providing a vehicle for advanced review of the data. Final contract deliverables can be consolidated and reduced by internal processing of LSAR data files, in part or in total. In addition, validated LSAR systems are required to have the capability to produce and load standard outputs not only for all data tables, but also standard outputs for "change only" data (changes to the data tables since the previous submittal of the LSAR data).

50.4 The third LSAR deliverables option is interactive access to a performing activity's LSA database by using a validated LSAR Relational software system. Interactive access includes the ability to selectively retrieve, review and print, and process performing activity LSA source data. Interactive access for faster requiring authority review of LSAR information represents more of a performing activity service capability than a specific deliverable requirement. This capability makes the most current authorized data available to the requiring authority and eliminates the time required for preparation and submission of deliverable products. It can also significantly reduce the time requirement for onsite reviews, while supporting internal analyses and planning that requires up-to-date supportability information. Interactive access provides the greatest flexibility for using LSAR data, either by utilizing the performing activity's automated LSAR capabilities, or by electronically transferring the data for further internal processing. Since interactive access can support interim and final delivery of both LSAR reports and data files, it may entirely eliminate the need to bring the LSAR data in-house. (However, it is advisable to have the LSAR relational table files delivered at contract completion.) The interactive access service can be very effective for satisfying LSAR deliverable requirements during the early life cycle phases when the volume of LSAR data is low. In latter phases, interactive access may be more appropriate as a contract compliance, "change only" data review, and internal analysis tool rather than for bulk transfers of complete LSAR master or data files.

LSAR DATA TABLES	AA	AB	AC	AD	AE	AF	AG	AH	AI	AJ	AK	BA	BB	BC	BD	BE	BF	BG	BH	BI	BJ	BK	BL	CA	
SYSTEM	A	A	A	A	A	A	A	A	A	A	A	A	A	A	A	A	A	A	A	A	A	A	A	A	
SUBSYSTEM	B	B	B	B	B	B	B	B	B	B	B	A	A	A	A	A	A	A	A	A	A	A	A	B	
REPAIRABLE ITEM	N	N	N	N	N	N	N	N	N	N	N	A	A	A	A	A	A	A	A	A	A	A	A	A	
PART	N	N	N	N	N	N	N	N	N	N	N	N	N	N	N	N	N	N	N	N	N	N	N	N	
SUPPORT EQUIPMENT	N	N	N	N	N	N	N	N	N	N	N	N	N	N	N	N	N	N	N	N	N	N	N	N	
LSAR DATA TABLES	CB	CC	CD	CE	CF	CG	CH	CI	CJ	CK	EA	EB	EC	ED	EE	EF	EG	EH	EI	EJ	EK	EL	EM	UA	
SYSTEM	A	A	A	A	A	A	A	A	B	B	N	N	N	N	N	N	N	N	N	N	N	N	N	B	
SUBSYSTEM	A	A	A	A	A	A	A	A	B	B	N	N	N	N	N	N	N	N	N	N	N	N	N	B	
REPAIRABLE ITEM	A	A	A	A	A	A	A	A	B	B	N	N	N	N	N	N	N	N	N	N	N	N	N	B	
PART	N	N	N	N	N	N	N	N	N	N	N	N	N	N	N	N	N	N	N	N	N	N	N	N	
SUPPORT EQUIPMENT	N	N	N	N	N	N	N	N	N	N	B	A	A	A	A	A	A	A	A	A	A	A	A	A	
LSAR DATA TABLES	UB	UC	UD	UE	UF	UG	UH	UI	UJ	UK	UL	UM	UN	UN	FA	FB	FC	FD	FE	GA	GB	GC	GD	GE	HA
SYSTEM	B	B	B	B	B	B	B	B	B	B	B	N	N	A	A	A	A	A	A	A	A	A	A	A	
SUBSYSTEM	B	B	B	B	B	B	B	B	B	B	B	N	N	A	A	A	A	A	A	A	A	A	A	A	
REPAIRABLE ITEM	B	B	B	B	B	B	B	B	B	B	B	N	N	B	B	B	B	B	B	A	A	A	A	A	
PART	N	N	N	N	N	N	N	N	N	N	N	N	N	N	N	N	N	N	N	N	N	N	N	N	
SUPPORT EQUIPMENT	A	A	A	A	A	A	A	A	A	A	A	A	A	A	A	A	A	A	A	A	A	A	A	A	

FIGURE 69. LSAR data table utilization by hardware breakdown.

LSAR DATA TABLES	HB	HC	HD	HE	HF	HG	HH	HI	HJ	HK	HL	HM	HN	HO	HP	HQ	HR	JA	JB	JC	JD	JE	JF	XA		
SYSTEM	A	A	A	A	A	A	A	A	A	A	A	A	A	A	A	A	A	A	A	A	A	A	A	A		
SUBSYSTEM	A	A	A	A	A	A	A	A	A	A	A	A	A	A	A	A	A	B	B	B	B	B	B	B	A	
REPAIRABLE ITEM	A	A	A	A	A	A	A	A	A	A	A	A	A	A	A	A	A	N	N	N	N	N	N	N	A	
PART	A	A	A	A	A	A	A	A	A	A	A	A	A	A	A	A	A	N	N	N	N	N	N	N	A	
SUPPORT EQUIPMENT	A	A	A	A	A	A	A	A	A	A	A	A	A	A	A	A	A	N	N	N	N	N	N	N	N	
LSAR DATA TABLES	XB	XC	XD	XE	XF	XG	XH	XI																		
SYSTEM	A	A	A	A	A	A	A	A																		
SUBSYSTEM	A	N	N	A	A	A	A	A																		
REPAIRABLE ITEM	A	N	N	A	A	A	A	A																		
PART	A	N	N	A	A	A	A	A																		
SUPPORT EQUIPMENT	N	N	N	N	N	N	N	N																		
<u>LEGEND</u>																										
A - Generally applicable																										
B - Dependent upon program requirements																										
N - Generally not applicable																										

FIGURE 69. LSAR data table utilization by hardware breakdown - continued.

MIL-STD-1388-2B
APPENDIX D

<u>DATA TABLE</u>	<u>DED</u>	<u>DATA ELEMENT</u>
AA	001	Achieved Availability
	064	Crew Size
	164	Inherent Availability
	222	Maximum Time To Repair
	223	Operational Mean Active Maintenance Downtime
	236	Operational Mean Time To Repair
AB	454	Total Systems Supported
	021	Annual Number of Missions
	022	Annual Operating Days
	024	Annual Operating Time
	228	Mean Mission Duration
BB	273	Operational Availability
	180	Item Function
	207	Maintenance Concept
CA	315	Qualitative and Quantitative Maintainability Requirements
	427	Task Code
	430	Task Frequency
	431	Task Identification
	358	Facility Requirement Code
	358	Tool/Support Equipment Requirement Code
EE	358	Training Equipment Requirement Code
	078	Description and Function of Support Equipment
FA	188	Justification
	118	Facility Name
FC	107	Facilities Maintenance Requirement
GC	007	New or Modified Skill Additional Requirements
	012	Additional Training Requirements
	094	Educational Qualifications
	188	Skill Justification

FIGURE 70. Concept exploration and definition phase LSAR.

MIL-STD-1388-2B
APPENDIX D

TABLE II. LSAR Data Tables Related to MIL-STD-1388-1 Tasks.

MIL-STD-1388-1 TASK/SUBTASK	APPLICABLE LSAR DATA TABLES
201.2.2	AE, AF, AH, BB, BL
203.2.3	BD, BE, FA, FB, FC
205.2.2	AA, AB, AC, AD, AE, AG, AH, AI, AJ, GA
205.2.3	AA, AB, AC, AD, AE, AG, AH, AI, AJ, GA
205.2.5	AA, AB, AC, AD, AE, AG, AH, AI, AJ, GA
301.2.4	BA, BB, BC, BD, BE, BF, BG, BH, BI, BJ, BK, BL, CA, CB, CC, CD, CE, CF, CG, CH, CI, CJ, CK, GA, XI
301.2.5	AA, AB, AC, AD, AE, AG, CA, CB, CC, CD, CE, CF, CG, CH, CI, XI
303.2.7	AI, XA, HG
401.2.1	CA, CB, CC, CD, CE, CF, CG, CH, CI, XI
401.2.2	CA, CB, CC, CD, CE, CF, CG, CH, CI, XI
401.2.3	EA, EB, EC, ED, EE, EF, EG, EH, EI, EJ, EK, EL, EM, FD, GB, GC, GD, UA, UB, UC, UD, UE, UF, UG, UH, UI, UJ, UK, UL, UM, UN
401.2.4	EE, GA, GB, GC, GD
401.2.5	CA, CB, CC, CD, CE, CF, CG, CH, CI, FA, FB, FC, FD, FE, XI
401.2.7	JA, JB, JC, JD, JE, JF
401.2.8	HA, HB, HC, HD, HE, HF, HG, HH, HI, HJ, HK, HL, HM, HN, HO, HP, HQ, HR, XB, XC, XD, XE, XF, XG
401.2.9	All tables as applicable, except the "A" tables
401.2.10	All tables as applicable
401.2.11	All tables as applicable
401.2.12	HA, HB, HG
501.2.4	All tables as applicable

DATA ITEM DESCRIPTION NUMBER AND TITLE	PURPOSE	LSAR APPLICATION/LSAR INTERFACE
<p>DESIGN INFLUENCE AND INTEGRATION TO INCLUDE LOGISTIC RELATED RELIABILITY AND MAINTAINABILITY</p> <p>DI-ILSS-81162A, LSA-050, Reliability Centered Maintenance Summary</p>	<p>This report is used to analyze the impacts of the RCM decisions in order impact design and supportability decisions.</p>	<p>The LSA-050, summary provides all the data to satisfy this DID. This requirement is specified by appendix B, paragraph 30.30.</p>
<p>DI-ILSS-81163A, LSA-056, Failure Modes, Effects and Criticality Analysis (FMECA) Report</p>	<p>This report provides an analysis of independent single item failures and the resulting potential impact on mission success performance, personnel safety, and maintainability. The analysis promotes design corrective actions by identifying potential failure risks in order that appropriate actions may be taken to eliminate or control the high risk items.</p>	<p>The LSAR provides all the FMECA worksheet data necessary to satisfy the requirements of this DID. Additional information such as FMECA assumptions, block diagrams, excluded items list, critical components, etc., may also be required. The LSA-056 summary is the FMECA report specified by appendix B, paragraph 30.31.</p>
<p>MAINTENANCE PLAN</p> <p>DI-ILSS-81140A, LSA-004, Maintenance Allocation Chart</p>	<p>The MAC is a management tool which assigns all maintenance functions and repair operations performed by the lowest appropriate maintenance category, and delineates the tools and test equipment requirements required to perform the operations. The MAC is used as appendix B of the Organizational Maintenance manual.</p>	<p>The LSA-004 summary provides all the data requirements of this DID for sections II, III, and IV. Section I is prepared in accordance with MIL-M-63038B(TM). This requirement is specified by appendix B, paragraph 30.3.</p>
<p>DI-ILSS-81183A, LSA-023, Maintenance Plan Summary</p>	<p>This report consists of four parts which may be provided together or individually. Part I contains general information pertaining to the system/</p>	<p>The LSA-023 summary provides all the data requirements necessary to completely satisfy this DID. This requirement is specified by appendix</p>

TABLE III. Data item description (DID) relationships to the LSAR.

DATA ITEM DESCRIPTION NUMBER AND TITLE	PURPOSE	LSAR APPLICATION/LSAR INTERFACE
<p>DI-ILSS-80119C, LSA-024, Maintenance Plan</p>	<p>end item and the maintenance/support concept. Part II contains reliability and maintainability characteristics of the item. Part III lists corrective and preventive maintenance required, and part IV lists support and associated technical data.</p>	<p>B, paragraph 30.17.</p>
<p>DI-ILSS-81138A, LSA-024, Maintenance Plan</p>	<p>This report consists of three parts. Part I contains general considerations (design description, maintenance plan summary, and maintenance plan rationale), Part II describes the repair capability required to support the item. Part III contains a list of maintenance tasks by category (preventive, corrective, servicing and calibration).</p>	<p>The LSA-024 summary provides all the data requirements necessary to completely satisfy this DID. This requirement is specified by appendix B, paragraph 30.28, and OPNAVINST 5000.49A.</p>
<p>MANPOWER AND PERSONNEL</p>		
<p>DI-ILSS-81138A, LSA-001, Annual Man-Hours by Skill Specialty Code and Level of Maintenance</p>	<p>This report provides a summary of manpower requirements for a system/equipment, and is used to determine time required and number of persons to perform each operations/maintenance task.</p>	<p>The LSA-001 summary provides all the data requirements necessary to completely satisfy this DID. This requirement is specified by appendix B, paragraph 30.1.</p>
<p>DI-ILSS-81165A, LSA-065, Manpower Requirements Criteria</p>	<p>This report identifies a summary of man-hour information by scheduled and unscheduled, on equipment; and unscheduled, off equipment.</p>	<p>The LSA-065 summary provides all the data requirements necessary to completely satisfy this DID. This requirement is specified by appendix B, paragraph 30.33.</p>
<p>DI-ILSS-80290B, LSA-075, Consolidated Manpower, Personnel and Training Report.</p>	<p>This report identifies critical manpower and personnel data by maintenance level and new/modified skill requirements as a baseline for performing hardware/manpower analysis.</p>	<p>The LSA-075 summary provides all the data requirements necessary to completely satisfy this DID. This requirement is specified by appendix B, paragraph 30.38.</p>

TABLE III. Data item description (DID) relationships to the LSAR - Continued.

DATA ITEM DESCRIPTION NUMBER AND TITLE	PURPOSE	LSAR APPLICATION/LSAR INTERFACE
<p>SUPPLY SUPPORT</p> <p>DI-ILSS-81285, Provisioning Technical Documentation, Provisioning Parts List option</p>	<p>The PPL is a listing of components, assemblies, and support items used in the end item which are furnished under contract. The list is used to determine the range and quantity of support items for an initial period of time.</p>	<p>The LSA-036 summary provides all the data requirements necessary to completely satisfy this DID. This requirement is specified by appendix B, paragraph 30.25, and MIL-STD-1388-1A, paragraph 401.2.8.</p>
<p>Short Form Provisioning Parts List option</p>	<p>The SFPPL serves as an early identification of support items which are recommended by the contractor for initial provisioning.</p>	<p>The LSA-036 summary provides all the data requirements necessary to completely satisfy this DID. This requirement is specified by appendix B, paragraph 30.25, and MIL-STD-1388-1A, paragraph 401.2.8.</p>
<p>Long Lead Times Item List option</p>	<p>The LLTIL is a listing of those items which, because of their complexity of design, complicated manufacturing process or limited production capacity may cause production cycles, which would preclude timely delivery if ordered in advance of normal provisioning.</p>	<p>The LSA-036 summary provides all the data requirements necessary to completely satisfy this DID. This requirement is specified by appendix B, paragraph 30.25, and MIL-STD-1388-1A, paragraph 401.2.8.</p>
<p>Repairable Items List option</p>	<p>This list identifies all items which are repairable within the breakdown of the end item.</p>	<p>The LSA-036 summary provides all the data requirements necessary to completely satisfy this DID. This requirement is specified by appendix B, paragraph 30.25, and MIL-STD-1388-1A, paragraph 401.2.8.</p>
<p>Interim Support Items List option</p>	<p>This list identifies those items required for support between initial operational capability and the point in time when standard provisioning is accomplished.</p>	<p>The LSA-036 summary provides all the data requirements necessary to completely satisfy this DID. This requirement is specified by appendix B, paragraph 30.25, and MIL-STD-1388-1A, paragraph 401.2.8.</p>

TABLE III. Data item description (DID) relationships to the LSAR - Continued.

DATA ITEM DESCRIPTION NUMBER AND TITLE	PURPOSE	LSAR APPLICATION/LSAR INTERFACE
Tool and Test Equipment List option	The TTEL identifies support items required to repair an end item. The list is used in the procurement of required items to support the end item under contract.	The LSA-036 summary provides all the data requirements necessary to completely satisfy this DID. This requirement is specified by appendix B, paragraph 30.25, and MIL-STD-1388-1A, paragraph 401.2.8.
Common and Buld Items List option	The CBIL provides a composite of common hardware and consumables necessary to support routine maintenance of a component and not otherwise classified as a repair part.	The LSA-036 summary provides all the data requirements necessary to completely satisfy this DID. This requirement is specified by appendix B, paragraph 30.25, and MIL-STD-1388-1A, paragraph 401.2.8.
Design Change Notice option	This list identifies those changes made to previously provisioned items. Items are identified as added, deleted, superseded, or modified.	The LSA-036 summary provides all the data requirements necessary to completely satisfy this DID. This requirement is specified by appendix B, paragraph 30.25, and MIL-STD-1388-1A, paragraph 401.2.11.
Post Conference List option	The PCL provides a reviewed and approved list of support items required for the maintenance and support of the system/end item or assembly.	The LSA-036 summary provides all the data requirements necessary to completely satisfy this DID. This requirement is specified by appendix B, paragraph 30.25, and MIL-STD-1388-1A, paragraph 401.2.8.
System Configuration Provisioning List option	The SCPL provides a listing of interfacing items between provisioned end items relating these to an entire system breakdown.	The LSA-036 summary provides all the data requirements necessary to completely satisfy this DID. This requirement is specified by appendix B, paragraph 30.25, and MIL-STD-1388-1A, paragraph 401.2.8.
DI-ILSS-81287, LSA-151, Provisioning Parts List Index (PPLI)	The PPLI is a companion document to other provisioning lists and provides summary information on each line item of the provisioning list.	The LSA-151 summary provides all the data requirements necessary to completely satisfy this DID. This requirement is specified by appendix B, paragraph 30.25, and MIL-STD-1388-1A, paragraph 401.2.8.

TABLE III. Data item description (DID) relationships to the LSAR - Continued.

DATA ITEM DESCRIPTION NUMBER AND TITLE	PURPOSE	LSAR APPLICATION/LSAR INTERFACE
DI-ILSS-80293B, LSA-155, Recommended Spare Parts List for Spares Acquisition Integrated with Production (SAIP)	This list provides the contractor's recommendations for support item candidates for the SAIP program.	The LSA-155 summary provides all the data requirements necessary to completely satisfy this DID. This requirement is specified by appendix B, paragraph 30.48, and MIL-STD-1388-1A, paragraph 401.2.6.
DI-ILSS-81287, Provisioning and Other Preprocurement Screening	This summary is used to identify existing national stock numbers and cataloging information by creating "LSR" type screening transactions.	The LSA-032 summary provides all the data requirements necessary to completely satisfy this DID. This requirement is specified by appendix B, paragraph 30.23, and MIL-STD-1388-1A, paragraph 202.2.5.
SUPPORT EQUIPMENT AND TEST MEASUREMENT AND DIAGNOSTIC EQUIPMENT		
DI-ILSS-80118C, LSA-070, Support Equipment Recommendation Data (SERD)	This report consist of six sections. It represents the contractor's recommendations for maintenance level operational support equipment necessary for organizational, intermediate, and depot level maintenance.	The LSA-070 summary provides all the data requirements necessary to completely satisfy this DID. Appendix B, paragraph 30.34, and MIL-STD-2097 cite the requirement for a SERD summary.
DI-ILSS-81166A, LSA-071, Support Equipment Candidate List	This report provides a consolidated listing of active and disapproved support equipment (SE) candidates in order to better manage these critical support items.	The LSA-071 summary provides all the data requirements necessary to completely satisfy this DID. Appendix B, paragraph 30.35, cites the requirement for an SE candidate list.
DI-ILSS-80288B, LSA-072, Test, Measurement, and Diagnostic Equipment (TMDE) Requirements Summary	This report identifies a TMDE item and provides a summary of TMDE requirements and technical description to verify the applicability of the test	The LSA-072 summary provides all the data requirements necessary to completely satisfy this DID. Paragraph 30.36, appendix B, cites the

TABLE III. Data item description (DID) relationships to the LSAR - Continued.

DATA ITEM DESCRIPTION NUMBER AND TITLE	PURPOSE for use on the system/end item.	LSAR APPLICATION/LSAR INTERFACE requirement for an LSA-072 summary
DI-ILSS-80289B, LSA-074, Support Equipment Tool List	This report identifies stock listed tools, commercially available tools, modified tools, stock listed and commercial, and tools requiring development.	The LSA-074 summary provides all the data requirements necessary to completely satisfy this DID. This requirement is specified by appendix B, paragraph 30.37.
DI-ILSS-81167A, LSA-076, Calibration and Measurement Requirements Summary	This report provides information concerning calibration intervals and parameters for calibration measurement.	The LSA-076 summary provides all the data requirements necessary to completely satisfy this DID. This requirement is specified by appendix B, paragraph 30.39, and MIL-STD-1839.
TECHNICAL DATA AND MANUALS		
DI-ILSS-81153A, LSA-019, Task Analysis Summary	This report provides a listing of personnel and support items to perform each operations/maintenance task, and the step-by-step sequential task procedures. It is used as source information in preparation of narrative technical publications.	The LSA-019 summary provides all the data requirements necessary to completely satisfy this DID. This requirement is specified by appendix B, paragraph 30.16.
DI-ILSS-81156A, LSA-030, Indented Parts List, Repair Parts and Special Tools List (RPSTL) Option	This report consists of four sections which are used to satisfy the listing and indexes requirements of a repair parts manual. It consists of general instructions, repair parts, list, special tools list, and four cross-reference indexes.	This LSA-030 option provides all the data requirements necessary to completely satisfy this DID. This requirement is specified by appendix B, paragraph 30.22, and MIL-STD-335, paragraph 5.
Stockage List Type Four Report Option	This report is used to satisfy the listing portion of part I, Item Identification Listing for a Type Four Stockage List Manual (Marine Corps).	This LSA-030 option provides all the data requirements necessary to completely satisfy this DID. This requirement is specified by appendix B, paragraph 30.22.

TABLE III. Data item description (DID) relationships to the LSAR - Continued.

DATA ITEM DESCRIPTION NUMBER AND TITLE	PURPOSE	LSAR APPLICATION/LSAR INTERFACE
<p>Illustrated Parts Breakdown Option</p>	<p>This report is used to satisfy Section II, Maintenance Parts List, and Section III, Numerical Index, of the IPB.</p>	<p>This LSA-030 option provides all the data requirements necessary to completely satisfy this DID. This requirement is specified by appendix B, paragraph 30.22, and MIL-M-38807.</p>
<p>DI-ILSS-81157A, LSA-033, Preventive Maintenance Checks and Services (PMCS)</p>	<p>This report identifies the crew/operator PMCS necessary for the operator's technical manual.</p>	<p>The LSA-033 summary provides all the data requirements necessary to completely satisfy this DID. This requirement is specified by appendix B, paragraph 30.24, and MIL-M-63036(TM).</p>
<p>DI-ILSS-81160A, LSA-040, Authorization List Items Option</p>	<p>This report, consisting of four sections, are listings required for an operator's or combined operator's and maintenance manual. The sections are: components of end item; basic issue items list; additional authorization list items; and, expendable/durable supplies and materials list items.</p>	<p>This LSA-040 option provides all the data requirements necessary to completely satisfy this DID. This requirement is specified by appendix B, paragraph 30.28, and MIL-M-63036(TM).</p>
<p>Stockage List Type Three Option</p>	<p>This report, consisting of three sections, are listings required for a stockage list type three (Marine Corps) manual. The sections are: supply system responsible items (also listing principal end items), using unit responsible items, and collateral equipment.</p>	<p>This LSA-040 option provides all the data requirements necessary to completely satisfy this DID. This requirement is specified by appendix B, paragraph 30.28.</p>
<p>PACKAGING, HANDLING AND STORAGE DI-PACK-80120, Preservation and Packing Data</p>	<p>This report provides detailed packing information necessary to determine packing level requirements.</p>	<p>The LSA-025 summary provides all the data requirements necessary to completely satisfy this DID. This requirement is specified by appendix B, paragraph 30.28.</p>

TABLE III. Data item description (DID) relationships to the LSAR - Continued.

DATA ITEM DESCRIPTION NUMBER AND TITLE	PURPOSE	LSAR APPLICATION/LSAR INTERFACE
<p>TRANSPORTATION AND TRANSPORTABILITY</p> <p>DI-ILSS-81170A, LSA-085, Transportability Summary</p>	<p>This report identifies information critical to the shipping and transport of major end items of equipment.</p>	<p>B, paragraph 30.19, and MIL-STD-2073-1A, appendix K.</p> <p>The LSA-085 summary provides all the data requirements necessary to completely satisfy this DID. This requirement is specified by appendix B, paragraph 30.43.</p>
<p>FACILITIES</p> <p>DI-ILSS-81148A, LSA-012, Facility Requirement</p>	<p>This report identifies tasks which require new or modified facilities or facility requirements for training. Also included in this summary are narrative explanations, descriptions, and justifications of facility requirements.</p>	<p>The LSA-012 summary provides all the data requirements necessary to completely satisfy this DID. This requirement is specified by appendix b, paragraph 30.11.</p>
<p>DI-ILSS-80291B, LSA-077, Depot Maintenance Inter- service Data Summary</p>	<p>This report identifies depot requirements divided into three parts. Part I contains all repairable items and the applicable tasks which are performed at depot. Part II lists all required support equipment and new, modified, or existing depot facility requirements. Part III provides detailed information concerning depot support equipment and associated test program sets.</p>	<p>The LSA-077 summary provides all the data requirements necessary to completely satisfy this DID. This requirement is specified by appendix B, paragraph 30.40.</p>
<p>HUMAN SYSTEMS INTEGRATION</p> <p>DI-ILSS-81152, LSA-018, Task Inventory Report</p>	<p>This report provides a complete listing of Jobs and Duties with their related operating and maintenance tasks,</p>	<p>The LSA-018 summary provides all the data requirements necessary to completely satisfy this DID. This</p>

TABLE III. Data item description (DID) relationships to the LSAR - Continued.

DATA ITEM DESCRIPTION NUMBER AND TITLE	PURPOSE	LSAR APPLICATION/LSAR INTERFACE
	<p>subtasks, and elements. It is useful to human systems integration specialists in particular.</p>	<p>requirement is specified by appendix B, paragraph 30.15.</p>

TABLE III. Data item description (DID) relationships to the LSAR - Continued.

APPENDIX E

DATA ELEMENT DICTIONARY

10 PURPOSE. This appendix provides the Data Element Dictionary for the Logistic Support (LSA) Analysis Record (LSAR) and information for interpreting and using it. The dictionary contains all the data elements and names that appear on the LSAR data relationship tables.

20 SECTIONS. The dictionary is divided into three sections.

20.1 Section 1: Index of data element titles. This section contains listing of data element definition (DED) numbers and titles. For each DED, the relational table location(s) in which the data element appears, by table and element codes, are depicted.

20.2 Section 2: Listing of data element codes. This section is an alphabetical listing of the data element codes used on the LSAR data relational tables with cross-references to the data element roll names they represent. Also listed are the applicable DED numbers.

20.3 Section 3: DEDs. This section contains definitions for all data elements that appear on the LSAR data relationship tables. The DED contains some or all of the following entries. When a standard data element acronym applies, this is also listed in this section.

- a. DED number
- b. Data element title with acronym
- c. Field format
- d. DED
- e. Data item(s)
- f. Data code(s)
- g. Role name(s)

20.3.1 Format. The general format for the DED is as follows:

DED #	DATA ELEMENT TITLE (ACRONYM)	FIELD FORMAT
	DATA ELEMENT DEFINITION	
	DATA ITEM(S)	DATA CODE(S)
	ROLE NAME(S)	

Example of actual DED entry:

339 RELIABILITY/MAINTAINABILITY 1 A F -
INDICATOR CODE

A code used to indicate whether the reliability and maintainability parameters entered on the card are allocated, predicted, measured, or comparability analysis values.

Comparability analysis	C
Allocated	A
Predicted	P
Measured	M

20.3.2 Definition of terms.

20.3.2.1 DED number. A sequentially assigned number to each data element in the dictionary for use in locating and referencing it throughout the dictionary and data entry instructions (appendix A).

20.3.2.2 Data element title. The noun phrase name used to identify the data element. Sufficient adjectival modifiers are used with the noun name to ensure title uniqueness.

20.3.2.3 Field format. A specification for the length, type, positional justification, and decimal placement of a data element field, or subfield thereof, as described below:

a. Length. The number of character positions in the data element. In the event the length is variable, the maximum length is specified.

b. Type. A specification of the character type, wherein:

"A" specifies that all characters of the data entry are upper case alphabetical.

"N" specifies that all characters of the data entry are numerical.

"X" specifies that characters of the data entry are upper case alphabetical, numerical, special, or any combination thereof.

"D" specifies that characters of the data entry are numerical with floating decimal. Decimals may be entered as required or exponentially, e.g., "0.0000325" or "3.25E-5".

c. Justification. Specifies from which side of the field the characters of the data element are entered. Those starting at the left are left justified (L), those starting at the right are right justified (R). Those which always occupy the entire field are fixed (F), as shown below. A dash (-) is used if this column is not applicable.

:	(L)	:	3	:	1	:	0	:	2	:	:	:	:
:	(R)	:	:	:	:	:	3	:	1	:	0	:	2
:	(F)	:	1	:	3	:	1	:	0	:	2	:	0
:		:		:		:		:		:	0	:	5

d. Decimal Placement. Specifies the number of character positions to the right of the assumed decimal point when the data element is numeric in all character positions. A dash (-) is used if this column is not applicable. AS means "As Specified" and the detailed instructions will indicate the location of decimal points.

20.3.2.4 DED. A narrative definition of the data element in sufficient detail to present a clear and complete understanding of the precise data or element of information that the data element represents.

20.3.2.5 Data item. One of a set of descriptive items of information or values that apply to a data element. For example, the data element "Skill Level Code" contains the data items "Basic", "Intermediate", and "Advanced".

20.3.2.6 Data code. One or more alphabetical, numerical, special characters, or any combination thereof, that represent a data item and that are to be entered in a field on an LSAR data record. A code is used instead of the data item itself, in order to conserve space on the data records and to facilitate machine processing. For example, under the data element "Security Clearance", and the Data Items "Top Secret", "Secret", "Confidential" and "Unclassified", are represented by the data codes "1", "2", "3", and "4", respectively.

Note 1: In some cases, a position left blank counts as a data code signifying some particular data item value as specified in the dictionary. For example for the data element, "Maximum Allowable Operating Time", the third position of the four-position code designates the appropriate multiplier code. The codes are " " (blank), X, C, or M, with a " " (blank) designating a multiplier of one (1), "x" a multiplier of ten (10), "C" a multiplier of one hundred (100), and "M" a multiplier of one thousand (1000).

Note 2: When data items and data codes are too voluminous to be included in this document, reference is made to items and codes in another document. For example, see Skill Specialty Code, DED No. 379.

20.3.2.7 Role name. A unique modifier of a data element title which describes the use/application of the data element within a specific relational data table location.

MIL-STD-1388-2B
APPENDIX E

APPENDIX E - SECTION 1

INDEX OF DATA ELEMENT TITLES

<u>DED</u>	<u>DATA ELEMENT TITLE</u>	<u>TABLE LOCATION</u>
001	Achieved Availability	AA.ACHAVAAA, BD.ACHAVABD
002	Acquisition Decision Office	EA.AQDCOFEA
003	Acquisition Method Code	HA.ACQMETHA
004	Acquisition Method Suffix Code	HA.AMSUFCHA
005	Adapter/Interconnection Device Required	EA.AIDRQDEA
006	Additional Reference Number	HB.ADDREFHB
007	Additional Skill Requirement: Skill Requiring a New or Revised Skill Code	GC.NMSNARGC, GC.NMSNCDGC (A)
008	Additional Skills and Special Training Requirements	EE.SEQNAREE, EE.SENARCEE (F)
009	Additional Specifications/ Requirements	AF.WPADDRAF
010	Additional Supportability Considerations	AK.SEINARAK, AK.SEINCDAK (A)
011	Additional Supportability Parameters	AK.SEINARAK, AK.SEINCDAK (B)
012	Additional Training Requirements	GC.NMSNARGC, GC.NMSNCDGC (D)
013	Administrative and Logistic Delay Time	AB.OPALDTAB, BE.ALDTXXBE
014	Administrative Lead Time	XA.ADDLTMXA
015	Allocation Data	EB.ALDCNMEB, EB.ALORG1EB EB.ALORG2EB, EB.ALORG3EB EB.ALORG4EB, EB.ALORG5EB

MIL-STD-1388-2B
APPENDIX E

<u>DED</u>	<u>DATA ELEMENT TITLE</u>	<u>TABLE LOCATION</u>
		EB.ALORG6EB, EB.ALORG7EB EB.ALORG8EB, EB.ALORG9EB EB.ALORG10EB, EB.ALDNDSEB EB.ALEXRNEB, EB.ALLVCDEB EB.ALMLVLEB, EB.ALSTIDEB
016	Allowance	UA.UTALLOUA, UM.SUTALLUM
017	Allowance Item Code	HG.ALLOWCHG
018	Allowance Item Quantity	HG.ALIQTYHG
019	Alternate Logistic Support Analysis Control Number Code	XB.ALTLCNXB, XC.ALTLCNXB XD.ALTLCNXB, XE.ALTLCNXE XE.ALCSEIXE, XF.ALTLCNXF XF.ALCSEIXF, XG.PALCNCXG XG.FALCNCXG AA.ALTLCNXB, AB.ALTLCNXB AC.ALTLCNXB, AD.ALTLCNXB AE.ALTLCNXB, AF.ALTLCNXB AG.ALTLCNXB, AH.ALTLCNXB AJ.ALTLCNXB, AK.ALTLCNXB BA.ALTLCNXB, BB.ALTLCNXB BC.ALTLCNXB, BD.ALTLCNXB BE.ALTLCNXB, BF.ALTLCNXB BG.ALTLCNXB, BH.ALTLCNBH BH.TALCNCBH, BI.ALTLCNXB BJ.ALTLCNXB, BK.ALTLCNXB CA.ALTLCNXB, CA.REFALCCA CA.AORALCCA, CB.ALTLCNXB CB.RFDALCCB, CC.ALTLCNXB CD.ALTLCNXB, CF.ALTLCNXB CG.ALTLCNXB, CH.ALTLCNXB CI.PROALCCI, CI.TSKALCCI CK.ALTLCNXB UA.UUTALCUA, UB.UUTALCUA UD.UUTALCUA, UF.UUTALCUA UG.UUTALCUA, UH.TSKALCCI UH.PROALCCI, UJ.UUTALCUA UL.UUTALCUA FE.ALTLCNXB, GE.ALTLCNXB HG.ALTLCNXB, HH.ALTLCNXB HI.ALTLCNXB, HJ.ALTLCNXB HK.ALTLCNXB, HL.ALTLCNXB HN.ALTLCNHN, HN.ALCSEIHN HO.ALTLCNHO, HO.ALCSEIHO HP.ALTLCNXB, HQ.ALTLCNXB HR.ALTLCNHO, HR.ALCSEIHO

MIL-STD-1388-2B
APPENDIX E

<u>DED</u>	<u>DATA ELEMENT TITLE</u>	<u>TABLE LOCATION</u>
		JA.ALTLCNXB, JB.ALTLCNXB JC.ALTLCNXB, JD.ALTLCNXB JE.ALTLCNXB, JF.ALTLCNXB
020	Annual Man-Hours	AC.MLSAMHAC, AC.MLUAMHAC
021	Annual Number of Missions	AB.ANNOMIAB
022	Annual Operating Days	AB.ANOPDAAB
023	Annual Operating Requirements	AG.ANOPREAG
024	Annual Operating Time	AB.ANOPTIAB
025	Apportioned Unit Cost	UC.OTPACRUC, UC.OTPACNUC UE.TPAUCRUE, UE.TPAUCNUE UI.AIDUCRUI, UI.AIDUCNUI
026	Armed Services Vocational Aptitude Battery Score	GB.ABAFQTGB, GB.AAEXRLGB GB.AAEXRHGB, GB.AALPRLGB GB.AALPRHGB, GD.ASVAPEGD GD.AAEERLGD, GD.AAEERHGD GD.AAELPLGD, GD.AAELPHGD
027	Automatic Data Processing Equipment Code	HA.ADPEQPHA
028	Available Man-Hours	AE.AVAIMHAE
029	Axle Length	JC.TWALFIJC, JC.TWALFOJC JC.TWALRIJC, JC.TWALROJC
030	Basis of Issue	HM.BOICTRHM, HM.QTYBOIHM HM.RATIOBHM, HM.LVLBOIHM
031	Built-In-Test Cannot Duplicate Percentage	BA.BITNDPBA
032	Built-In-Test Detectability Level Percentage	BA.BDLPGABA, BA.BDLPGBBA
033	Built-In-Test Retest OK Percentage	BA.BITROPBA
034	Calibration and Measurement Requirement Summary Parameter Code	UG.UUTPPCUG, UN.UTPACMUN
035	Calibration and Measurement Requirement Summary Recommended	EA.CMRSRCEA, UB.UTCMRSUB

MIL-STD-1388-2B
APPENDIX E

<u>DED</u>	<u>DATA ELEMENT TITLE</u>	<u>TABLE LOCATION</u>
036	Calibration and Measurement Requirement Summary Status	UB.UTSTCDUB, UM.SUTSTCUM
037	Calibration Interval	EA.CALINTEA
038	Calibration Item	EA.CALITMEA
039	Calibration Procedure	EC.CALPROEC
040	Calibration Required	EA.CALRQDEA
041	Calibration Standard	EA.CALSTDEA
042	Calibration Time	EA.CALTIMEA
043	Change Authority Number	HP.CANUMBHP, HQ.CANUMBHP HR.CANUMBHP
044	Characteristics of Support Equipment	EE.SEQNAREE, EE.SENARCEE (D)
045	Cleaning and Drying Procedure	HF.CDPROCHF
046	Commercial and Government Entity Code	XH.CAGECDXH, AH.IOCAGEAH CG.TSCAGECG, CI.PROCAGCI, EA.SECAGEEA, EB.SECAGEEA EC.SECAGEEA, ED.SECAGEEA EE.SECAGEEA, EF.SECAGEEA EG.SECAGEEA, EH.SECAGEEA EI.SECAGEEA, EJ.SECAGEEA EK.SECAGEEA, EK.SPRCAGEK EL.SECAGEEA, EM.SECAGEEA EM.SCAGECEM UB.SECAGEEA, UC.OTPCAGUC UD.SECAGEEA, UD.OTPCAGUC UE.OTPCAGUC, UE.TPICAGUE UG.SECAGEEA, UH.PROCAGCI UH.SECAGEEA, UI.AIDCAGUI UJ.SECAGEEA, UJ.AIDCAGUI UK.ATECAGUK, UL.SECAGEEA UL.ATECAGUK, UM.SUTCAGUM UN.TGSCAGUN, UN.SUTCAGUM HA.CAGECDXH, HB.CAGECDHB HB.ADCAGEHB, HC.CAGECDHC HC.CTCAGEHC, HD.CAGECDXH HE.CAGECDXH, HF.CAGECDXH HF.PKCAGEHF, HG.CAGECDXH HH.CAGECDXH, HI.CAGECDXH HJ.CAGECDXH, HK.CAGECDXH

MIL-STD-1388-2B
APPENDIX E

<u>DED</u>	<u>DATA ELEMENT TITLE</u>	<u>TABLE LOCATION</u>
		HL.CAGECDXH, HM.CAGECDXH HN.CAGECDHN, HO.CAGECDHO HP.CAGECDXH, HQ.CAGECDXH HR.CAGECDHO
047	Commercial and Government Entity Code Address	XH.CANAMEXH, XH.CASTREXH XH.CACITYXH, XH.CASTATXH XH.CANATNXH, XH.CAPOZOXH
048	Common Unit Under Test	UI.AIDCUTUI
049	Compensating Design Provisions	BJ.FMCNARBJ, BJ.FMMPCNBJ (A)
050	Compensating Operator Action Provisions	BJ.FMCNARBJ, BJ.FMMPCNBJ (B)
051	Concurrent Production Code	HD.CURPRCHD, HE.CURPRCHE
052	Contact Team Delay Time	XA.CTDLTMXA
053	Container Length	JB.CONLENJB
054	Container Type	JB.CONTYPJB
055	Contract Number	XA.CONTNOXA, EA.CNTRNOEA JA.CONNUMJA
056	Contractor Furnished Equipment/Government Furnished Equipment	EA.CFEGFEEA
057	Contractor Recommended	EJ.CNTRECEJ, EL.CONRECEL
058	Contractor Technical Information Code	HA.CTICODHA
059	Conversion Factor	BA.CONVFABA
060	Coordinated Test Plan	UC.OTPCTPUC
061	Cost per Reorder Action	XA.CSREORXA
062	Cost per Requisition	XA.CSPRRQXA
063	Crest Angle	JC.CREANGJC
064	Crew Size	AA.CREWSZAA
065	Critical Item Code	HA.CRITITHA
066	Criticality Code	HA.CRITCDHA
067	Cushioning and Dunnage Material Code	HF.CUSHMAHF

MIL-STD-1388-2B
APPENDIX E

<u>DED</u>	<u>DATA ELEMENT TITLE</u>	<u>TABLE LOCATION</u>
068	Cushioning Thickness	HF.CUSTHIHF
069	Custody Code	EA.CUSTCDEA
070	Data Status Code	HG.DATASCHG
071	Date	EA.DATFADEA, EF.INTSUBEF EF.DTGVDFEF, EF.DTRVSBF HA.WARDATHA, JA.TRCHRDJA
072	Deck Stowage	JB.SDECKSJB
073	Defense Logistics Services Center Screening Requirement Code	HA.DLSCRCHA
074	Degree of Protection Code	HF.DEGPROHF
075	Delivery Schedule	JA.DELSCHJA
076	Demilitarization Code	HA.DEMILIHA
077	Demilitarization Cost	XA.DEMILCXA
078	Description and Function of Support Equipment	EE.SEQNAREE, EE.SENARCEE (B)
079	Design Data Category Code	EJ.DSNDATEJ
080	Design Data Price	EA.DSNPRCEA
081	Designated Rework Point	HG.DRPONEHG, HG.DRPTWOHG
082	Disaster Response Force	JF.TRANARJF, JF.TRANCDJF (M)
083	Discount Rate	XA.DISCNTXA
084	Disposition	BF.RCMDSABF, BF.RCMDSBBF BF.RCMDSCBF, BF.RCMDSDBF BF.RCMDSEBF, BF.RCMDSFBF BF.RCMDSGBF, BF.RCMDSHBF BF.RCMDSIBF, BF.RCMDSJBF
085	Distance	AJ.SHPDISAJ
086	Document Availability Code	HA.DOCVCHA
087	Document Identifier Code	HA.DOCIDCHA
088	Drawing Classification	EA.DRWCLSEA, FA.DRCLASFA
089	Drawing Number	FA.FADNUMFA
090	Duty	CJ.DUTIESCJ

MIL-STD-1388-2B
APPENDIX E

<u>DED</u>	<u>DATA ELEMENT TITLE</u>	<u>TABLE LOCATION</u>
091	Duty Code	CJ.DUTYCDCJ, CK.DUTYCDCJ
092	Duty Position Requiring a New or Revised Skill	GB.DPRNRSGB
093	Economic Analysis	EA.ECOANLEA
094	Educational Qualifications	GC.NMSNARGC, GC.NMSNCDGC (B)
095	Element Indicator	CC.ELEMNTCC
096	End Item Acronym Code	XA.EIACODXA, XB.EIACODXA XC.EIACODXA, XD.EIACODXA XE.EIACODXA, XF.EIACODXA XG.EIACODXA AA.EIACODXA, AB.EIACODXA AC.EIACODXA, AD.EIACODXA AE.EIACODXA, AF.EIACODXA AG.EIACODXA, AH.EIACODXA AI.EIACODXA, AJ.EIACODXA AK.EIACODXA BA.EIACODXA, BB.EIACODXA BC.EIACODXA, BD.EIACODXA BE.EIACODXA, BF.EIACODXA BG.EIACODXA, BH.EIACODXA BI.EIACODXA, BJ.EIACODXA BK.EIACODXA, BL.EIACODXA CA.EIACODXA, CA.REFEIIACA CB.EIACODXA, CB.RFDEIIACB CC.EIACODXA, CD.EIACODXA CE.EIACODXA, CF.EIACODXA CG.EIACODXA, CH.EIACODXA CI.EIACODXA, CK.EIACODXA UA.EIACODXA, UB.EIACODXA UD.EIACODXA, UF.EIACODXA UG.EIACODXA, UH.EIACODXA UJ.EIACODXA, UL.EIACODXA FE.EIACODXA, GE.EIACODXA HG.EIACODXA, HH.EIACODXA HI.EIACODXA, HJ.EIACODXA HK.EIACODXA, HL.EIACODXA HN.EIACODXA, HO.EIACODXA HP.EIACODXA, HQ.EIACODXA HR.EIACODXA JA.EIACODXA, JB.EIACODXA JC.EIACODXA, JD.EIACODXA JE.EIACODXA, JF.EIACODXA

MIL-STD-1388-2B
APPENDIX E

<u>DED</u>	<u>DATA ELEMENT TITLE</u>	<u>TABLE LOCATION</u>
097	Engineering Failure Mode Mean Time Between Failure	BF.EFMTBFBF
098	Environmental Handling and Transportation Indicator	JA.ENHATCJA
099	Environmental/Hazardous Materials Considerations	JF.TRANARJF, JF.TRANCDJF (I)
100	Essentiality Code	HG.ESSCODHG
101	Estimated Price	EJ.ESTPRCEJ, EL.ESTPRCEL
102	Estimated Salvage Value	XA.ESSALVXA
103	Extended Unit Price	EA.EXUNPREA
104	External Or Internal Load Indicator	JB.EOILINJB
105	Facilities Design Criteria	FD.NMFNARFD, FD.NMFCDFD (A)
106	Facilities Installation Lead Times	FD.NMFNARFD, FD.NMFCDFD (B)
107	Facilities Maintenance Requirements	FC.FABNARFC, FC.FBNACDFC (A)
108	Facilities Requirements	FD.NMFNARFD, FD.NMFCDFD (E)
109	Facilities Requirements For Operations	FC.FABNARFC, FC.FBNACDFC (B)
110	Facilities Requirements For Training	FC.FABNARFC, FC.FBNACDFC (C)
111	Facilities Utilization	FD.NMFNARFD, FD.NMFCDFD (D)
112	Facility Area	FA.FAAREAFA
113	Facility Baseline Narrative Code	FC.FBNACDFC
114	Facility Capability	FB.FACNARFB, FB.FNCODEFB (A)
115	Facility Category Code	FA.FACCCDFA, FB.FACCCDFA FC.FACCCDFC, FD.FACCCDFD FE.FACCCDFA
116	Facility Class	FA.FACCLAFA
117	Facility Location	FB.FACNARFB, FB.FNCODEFB (B)

MIL-STD-1388-2B
APPENDIX E

<u>DED</u>	<u>DATA ELEMENT TITLE</u>	<u>TABLE LOCATION</u>
118	Facility Name	FA.FACNAMFA, FB.FACNAMFA FC.FACNAMFC, FD.FACNAMFD FE.FACNAMFA
119	Facility Narrative Code	FB.FNCODEFB
120	Facility Requirements: Special Considerations	FC.FABNARFC, FC.FBNACDFC (D)
121	Facility Requirements: Supply/Storage	FC.FABNARFC, FC.FBNACDFC (E)
122	Facility Task Area Breakdown	FD.NMFNARFD, FD.NMFNCDFD (C)
123	Facility Unit Cost Rationale	FD.NMFNARFD, FD.NMFNCDFD (F)
124	Failure Cause	BG.FMNNARBG, BG.FMNCNABG (D)
125	Failure/Damage Effects: End Effect	BG.FMNNARBG, BG.FMNCNABG (A)
126	Failure/Damage Effects: Local	BG.FMNNARBG, BG.FMNCNABG (B)
127	Failure/Damage Effects: Next Higher	BG.FMNNARBG, BG.FMNCNABG (C)
128	Failure/Damage Mode	BG.FMNNARBG, BG.FMNCNABG (E)
129	Failure Detection Method	BG.FMNNARBG, BG.FMNCNABG (F)
130	Failure Effect Probability	BI.FEPROBBI
131	Failure Mode and Reliability Centered Maintenance Narrative Code	BG.FMNCNABG
132	Failure Mode Classification	BF.FMCLASBF
133	Failure Mode Criticality Number	BI.FACRNUBI
134	Failure Mode Indicator	BF.FAMOINBF, BG.FAMOINBF BH.FAMOINBH, BI.FAMOINBF BJ.FAMOINBF
135	Failure Mode Indicator Mission Phase Characteristics Narrative Code	BJ.FMMPCNBJ
136	Failure Mode Ratio	BF.FMRATOFB
137	Failure Mode Remarks	BG.FMNNARBG, BG.FMNCNABG (H)

MIL-STD-1388-2B
APPENDIX E

<u>DED</u>	<u>DATA ELEMENT TITLE</u>	<u>TABLE LOCATION</u>
138	Failure Predictability	BG.FMNNARBG, BG.FMNCNABG (G)
139	Failure Probability Level	BI.FPROBLBI
140	Failure Rate	BD.FAILRTBD
141	Failure Rate Data Source	BA.FRDATA
142	Family Group	EA.FAMGRPEA
143	Fault Isolation	BA.FIAMBABA, BA.FIPFGABA BA.FIAMBBBA, BA.FIPFGBBA UH.UUTFA1UH, UH.UUTFA2UH UH.UUTFP1UH, UH.UUTFP2UH
144	Figure Number	HJ.FIGNUMHK, HK.FIGNUMHK HL.FIGNUMHK
145	Fiscal Year	HD.FISCYRHD, HE.FISCYRHE JE.TRAFJRJE
146	Freight Classification	JB.FRCLASJB
147	Functional Analysis	EE.SEQNAREE, EE.SENARCEE (A)
148	Generic Code	EA.GENECDEA
149	Government Designator	EA.GOVDESEA, UK.ATEGDSUK
150	Government Required	EJ.GOVRQDEJ, EL.GOVRQDEL
151	Hardness Critical Item	HG.HARDCIHG
152	Hardness Critical Procedures	CA.HRDCPCCA
153	Hardware Development Price	EA.HDWRPREA
154	Hazardous Code	HA.HAZCODHA
155	Hazardous Maintenance Procedures Code	CA.HAZMPCCA
156	Hazardous Materials Storage Cost	HA.HMSCOSHA
157	Hazardous Waste Disposal Cost	HA.HWDCOSHA
158	Hazardous Waste Storage Cost	HA.HWSCOSHA
159	Helicopter Mission Requirements	JB.HMATLRJB, JB.HMDISRJB JB.HMPAYRJB, JB.HMTMPRJB JB.HMTIMRJB

MIL-STD-1388-2B
APPENDIX E

<u>DED</u>	<u>DATA ELEMENT TITLE</u>	<u>TABLE LOCATION</u>
160	Holding Cost Percentage	XA.HLCSPCXA
161	Hourly Labor Rate Per Skill Speciality Code	GA.HRLARTGA
162	Indenture Code	HG.INDCODHG
163	Industrial Materials Analysis of Capacity	HA.INDMATHA
164	Inherent Availability	AA.INHAVAAA, BD.INHAVABD
165	Inherent Maintenance Factor	BD.INHMAFBD
166	Initial Bin Cost	XA.INTBINXA
167	Initial Cataloging Cost	XA.INCATCXA
168	Input Power Source	EI.IPSOPNEI, EI.IPACDCEI EI.IPFRMXEI, EI.IPRGMXEI EI.IPSRGMEI, EI.IPOPRGEI EI.IPMXRPEI, EI.IPPHASEI EI.IPPOWREI
169	Installation Factors or Other Facilities	EE.SEQNAREE, EE.SENARCEE (E)
170	Integrated Logistic Support Price	EA.ILSPRCEA
171	Integrated Logistic Support Requirements Category Code	EL.IRCCODEL
172	Interchangeability Code	EK.ICCODEEK, HP.INTCHCHP
173	Interest Rate	XA.INTRATXA
174	Intermediate Container Code	HF.INTCONHF
175	Intermediate Container Quantity	HF.INCQTYHF
176	Inventory Storage Space Cost	XA.INVSTGXA
177	Item Category Code	EA.SEICCDEA, HG.ITMCATHG
178	Item Criticality Number	BK.RICRITBK
179	Item Designator Code	XC.ITMDESXC, EA.ENDARTEA EM.GFAEIDEM
180	Item Function	BB.RAMNARBB, BB.RAMCNABB (A)
181	Item Management Code	HA.ITMMGCHA

MIL-STD-1388-2B
APPENDIX E

<u>DED</u>	<u>DATA ELEMENT TITLE</u>	<u>TABLE LOCATION</u>
182	Item Name	AH.IONAMEAH, EK.SUPITNEK HA.ITNAMEHA
183	Item Name Code	HA.INAMECHA
184	Item Number	HJ.ITEMNOHK, HK.ITEMNOHK HL.ITEMNOHK
185	Job	CJ.JOBDESCJ
186	Job Code	CJ.JOBCODCJ, CK.JOBCODCJ
187	Julian Date	HF.SPDATEHF
188	Justification	EE.SEQNAREE, EE.SENARCEE (H) FD.NMFNARFD, FD.NMFCDFD (G) GC.NMSNARGC, GC.NMSNCDGC (C)
189	Labor Rate	AI.LABRATAI
190	Life Cycle Status	EA.LICYSTEA
191	Life Span	EA.LIFSPNEA
192	Lifting and Tiedown Requirement for Transportation	JF.TRANARJF, JF.TRANCDJF (B)
193	Line Item Number	HA.LINNUMHA
194	Line Replaceable Unit	HG.LRUNITHG
195	Loading Factor	XA.LODFACXA
196	Logistic Considerations	BA.LOGACCBA, BA.LOGCONBA BA.LOGCRCBA, BA.LOGDSPBA BA.LOGFLOBA, BA.LOGLABBA BA.LOGMAIBA, BA.LOGPATBA BA.LOGSAFBA, BA.LOGSKIBA BA.LOGSTABA, BA.LOGTEPBA BA.LOGTRABA
197	Logistic Control Code	EA.LGCTCDEA
198	Logistic Decision Office	EA.LGDCOFEA
199	Logistic Support Analysis Control Number	XB.LSACONXB, XC.LSACONXB XD.LSACONXB, XE.LSACONXE XE.LCNSEIXE, XF.LSACONXF XF.LCNSEIXF, XG.PLSACNXG XG.FLSACNXG AA.LSACONXB, AB.LSACONXB AC.LSACONXB, AD.LSACONXB AE.LSACONXB, AF.LSACONXB

MIL-STD-1388-2B
APPENDIX E

<u>DED</u>	<u>DATA ELEMENT TITLE</u>	<u>TABLE LOCATION</u>
		AG.LSACONXB, AH.LSACONXB AJ.LSACONXB AK.LSACONXB BA.LSACONXB, BB.LSACONXB BC.LSACONXB, BD.LSACONXB BE.LSACONXB, BF.LSACONXB BG.LSACONXB, BH.LSACONBH BH.TLSACNBH, BI.LSACONXB BJ.LSACONXB, BK.LSACONXB
		CA.LSACONXB, CA.REFLCNCA CA.AORLCNCA, CB.LSACONXB CB.RFDLCNCB, CC.LSACONXB CD.LSACONXB, CF.LSACONXB CG.LSACONXB, CH.LSACONXB CI.PROLCNCI, CI.TSKLCNCI CK.LSACONXB, UA.UUTLCNUA UB.UUTLCNUA, UD.UUTLCNUA UF.UUTLCNUA, UG.UUTLCNUA UH.TSKLCNCI, UH.PROLCNCI UJ.UUTLCNUA, UL.UUTLCNUA
		FE.LSACONXB, GE.LSACONXB HG.LSACONXB, HH.LSACONXB HI.LSACONXB, HJ.LSACONXB HK.LSACONXB, HL.LSACONXB HN.LSACONHN, HN.LCNSEIHN HO.LSACONHO, HO.LCNSEIHO HP.LSACONXB, HQ.LSACONXB HR.LSACONHO, HR.LCNSEIHO JA.LSACONXB, JB.LSACONXB JC.LSACONXB, JD.LSACONXB JE.LSACONXB, JF.LSACONXB
200	Logistic Support Analysis Control Number Indenture Code	XB.LCNINDXB
201	Logistic Support Analysis Control Number Nomenclature	XB.LCNAMEXB
202	Logistic Support Analysis Control Number Structure	XA.LCNSTRXA
203	Logistic Support Analysis Control Number Type	XB.LCNTYPXB, XC.LCNTYPXB XD.LCNTYPXB, XE.LCNTYPXE XE.LTYSEIXE, XF.LCNTYPXF XF.LTYSEIXF, XG.PLCNTYXG XG.FLCNTYXG AA.LCNTYPXB, AB.LCNTYPXB AC.LCNTYPXB, AD.LCNTYPXB AE.LCNTYPXB, AF.LCNTYPXB AG.LCNTYPXB, AH.LCNTYPXB AJ.LCNTYPXB, AK.LCNTYPXB BA.LCNTYPXB, BB.LCNTYPXB

MIL-STD-1388-2B
APPENDIX E

<u>DED</u>	<u>DATA ELEMENT TITLE</u>	<u>TABLE LOCATION</u>
		BC.LCNTYPXB, BD.LCNTYPXB BE.LCNTYPXB, BF.LCNTYPXB BG.LCNTYPXB, BH.LCNTYPBH BH.TLCNTYBH, BI.LCNTYPXB BJ.LCNTYPXB, BK.LCNTYPXB
		CA.LCNTYPXB, CA.REFTYPCA CA.AORTYPCA, CB.LCNTYPXB CB.RFDTYPCB, CC.LCNTYPXB CD.LCNTYPXB, CF.LCNTYPXB CG.LCNTYPXB, CH.LCNTYPXB CI.PROLTYCI, CI.TSKLTYCI CK.LCNTYPXB, UA.UTLCNTUA UB.UTLCNTUA, UD.UTLCNTUA UF.UTLCNTUA, UG.UTLCNTUA UH.TSKLTYCI, UH.PROLTYCI UJ.UTLCNTUA, UL.UTLCNTUA
		FE.LCNTYPXB, GE.LCNTYPXB HG.LCNTYPXB, HH.LCNTYPXB HI.LCNTYPXB, HJ.LCNTYPXB HK.LCNTYPXB, HL.LCNTYPXB HN.LCNTYPXB, HO.LCNTYPXB HP.LCNTYPXB, HQ.LCNTYPXB HR.LCNTYPXB
		JA.LCNTYPXB, JB.LCNTYPXB JC.LCNTYPXB, JD.LCNTYPXB JE.LCNTYPXB, JF.LCNTYPXB
204	Logistic Support Analysis Recommendation Code	EA.LSARCDEA
205	Lot Quantity	HD.LOTQFMHD, HD.LOTQTOHD HE.LOTQFMHE, HE.LOTQTOHE
206	Maintenance Action Code	HG.MAIACTHG
207	Maintenance Concept	BB.RAMNARBB, BB.RAMCNABB (B)
208	Maintenance Interval	BH.MAININBH
209	Maintenance Plan Number	UA.UMNTPLUA, UM.MNTPLNUM
210	Maintenance Plan Rationale	BB.RAMNARBB, BB.RAMCNABB (E)
211	Maintenance Replacement Rate I	HG.MRRONEHG
212	Maintenance Replacement Rate II	HG.MRRTWOHG
213	Maintenance Replacement Rate Modifier	HG.MRRMODHG

MIL-STD-1388-2B
APPENDIX E

<u>DED</u>	<u>DATA ELEMENT TITLE</u>	<u>TABLE LOCATION</u>
214	Maintenance Task Distribution	HG.OMTDOOHG, HG.FMTDFFHG HG.HMTDHHHG, HG.LMTDLLHG HG.DMTDDDHG, HG.CBDMTDHG HG.CADMTDHG
215	Man-Hour Per Operating Hour	AC.MLSMHOAC, AC.MLUMHOAC
216	Management Plan	EA.MGTPLNEA
217	Managing Command/Agency	EA.MGCOATEA
218	Material	HA.MATERLHA
219	Material Leadtime	HA.MTLEADHA
220	Material Weight	HA.MTLWGTHA
221	Maximum Allowable Operating Time	HG.MAOTIMHG
222	Maximum Time To Repair	AA.MAXTTRAA, AC.MLMTTRAC BD.MAXTTRBD
223	Mean Active Maintenance Downtime	AA.OMAMDTAA, AA.TMAMDTAA
224	Mean Elapsed Time	CA.MSDMETCA, CA.PRDMETCA
225	Mean Man-Hours	CA.MSDMMHCA, CA.PRDMMHCA
226	Mean Man-Minutes	CD.SUBMMMCD
227	Mean Minute Elapsed Time	CB.SBMMETCB
228	Mean Mission Duration	AB.MMISDUAB
229	Mean Time Between Failures	AG.OPMTBFAG, AG.TEMTBFAG BD.OPMTBFBD, BD.TEMTBFBD EA.SEMTBFEA
230	Mean Time Between Maintenance Actions	AG.OPMRBMAG, AG.TMTBMAAG BD.OMTBMABD, BD.TMTBMABD EA.SMTBMAEA
231	Mean Time Between Maintenance Induced	BD.INMTBMBD
232	Mean Time Between Maintenance Inherent	BD.INHMTBBD
233	Mean Time Between Maintenance No Defect	BD.NOMTBMBD
234	Mean Time Between Preventive Maintenance	BD.MTBMPVBD

MIL-STD-1388-2B
APPENDIX E

<u>DED</u>	<u>DATA ELEMENT TITLE</u>	<u>TABLE LOCATION</u>
235	Mean Time Between Removals	AG.MTBRXXAG, BD.MTBRXXBD
236	Mean Time To Repair	AA.OPMTTRAA, AA.TEMTTRAA BD.MTTROPBD, BD.MTTRTHBD EA.SEMTTREA
237	Means of Detection	CA.PMDTECCA, CA.SMDTECCA
238	Measurement Base	AB.MMISDMAB, AG.MEASBSAG BA.WOLIMBBA, BD.FARAMBBD BD.OMTBFMBD, BD.TMTBFMBD BD.OMTBMMBD, BD.TMTBMMBD BD.IMTBMMBD, BD.INHMTMBD BD.NMTBMMBD, BD.MTBMPMBD BD.MTBRMBBD, BF.EFMMBBBF BH.MAINMBBH, BI.FMOTMBBI CA.AORMSBKA, HA.WARMBSHA
239	Method of Preservation	HF.MEPRESHF
240	Military Distance Classification	JF.TRANARJF, JF.TRANCDJF (J)
241	Military Load Classification (Empty/Loaded)	JC.HICLNEJC, JC.HICLNLJC
242	Military Unit Type	JA.MILUNTJA
243	Minimum Equipment List Indicator	BA.MEQLINBA
244	Minimum Equipment List Narrative	BB.RAMNARBB, BB.RAMCNABB (C)
245	Minimum Replacement Unit	HG.MINREUHG
246	Mission Phase Code	BI.MISSPCBL, BJ.MISSPCBL BK.MISSPCBL, BL.MISSPCBL
247	Mission Phase/Operational Mode	BL.MPOPLDBL
248	Mobile Facility Code	EA.MOBFACEA
249	Mobility Type	JC.MOBTYPJC, JD.MOBTYPJC
250	Model Load	JB.HIPRMLJB, JB.HALTMLJB
251	Model Type	JB.HIPRMTJB, JB.HALTMTJB
252	Modification or Change	EA.MODCHGEA
253	National Stock Number and Related Data	AH.IONIINAH, AH.IONFSCAH EH.ALTFSCEH, EH.ALTNIIEH HA.COGNSNHA, HA.SMMNSNHA HA.MATNSNHA, HA.FSCNSNHA

MIL-STD-1388-2B
APPENDIX E

<u>DED</u>	<u>DATA ELEMENT TITLE</u>	<u>TABLE LOCATION</u>
		HA.NIINSNHA, HA.ACTNSNHA HF.CONNSNHF
254	Net Explosive Weight	JA.NETEXWJA
255	New or Modified Facility Narrative Code	FD.NMFNCDFD
256	New or Modified Skill Narrative Code	GC.NMSNCDGC
257	New or Modified Skill Specialty Code	CD.MDCSSCGB, GB.MDCSSCGB, GC.MDCSSCGB, GD.MDCSSCGB GE.MDCSSCGB
258	Next Higher Assembly Provisioning List Item Sequence Number	HH.NHAPLIHH
259	Next Higher Assembly Provisioning List Item Sequence Number Indicator	HH.NHAINDHH
260	Nonoperability, Fragility Factor	JA.NOPRFFJA
261	Not Repairable This Station	HG.NORETSHG
262	Number of Operating Locations	AA.NUOPLOAA
263	Number of Shops	AI.NOSHPSAI
264	Number of Skids	JC.SNUMSKJC
265	Number of Systems Supported	AC.MLNSSUAC
266	Number Type	AH.IOINTYAH
267	Operating and Support Cost	EA.OSCOSTEA
268	Operating Dimensions	EA.OPRHGTEA, EA.OPLENGEA EA.OPWIDTEA
269	Operating Time	BI.FMOPTIBI
270	Operating Weight	EA.OPRWGTEA
271	Operation Level	XA.WSOPLVXA
272	Operation Life	XA.OPRLIFXA
273	Operational Availability	AB.OPAVAIAB, BE.OPAVAIIBE
274	Operational Mission Failure Definition	AK.SEINARAK, AK.SEINCDAC(C)

MIL-STD-1388-2B
APPENDIX E

<u>DED</u>	<u>DATA ELEMENT TITLE</u>	<u>TABLE LOCATION</u>
275	Operational Requirement Indicator	AB.OPRQINAB, AC.OPRQINAB AD.OPRQINAB, AE.OPRQINAB AF.OPRQINAB, AG.OPRQINAB BE.OPRQINBE
276	Operational Weight (Empty and Loaded)	JC.OPWEEMJC, JC.OPWELDJC
277	Operations/Maintenance Level	AC.OMLVLCAC, AD.OMLVLCAC AE.OMLVLCAC, AI.OMLVLCAI AJ.OMLVLFAJ, AJ.OMLVLTAJ EA.PCBLVLEA, EA.CALLVLEA EA.RPRLVLEA
278	Operator's Manual	EA.OPRMANEA
279	Optional Procedure Indicator	HF.OPTPRIHF
280	Organizational/On Equipment/Unit Operations and Maintenance Requirements	AD.DINMETAD, AD.DINMMHAD AD.PREMETAD, AD.PREMMHAD AD.POIMETAD, AD.POIMMHAD AD.PINMETAD, AD.PINMMHAD AD.MPCMETAD, AD.MPCMMHAD AD.TINMETAD, AD.TINMMHAD
281	Overhaul Replacement Rate	HH.OVHREPHH
282	Packaging Category Code	HF.PACCATHF
283	Packing Code	HF.PKGCODHF
284	Parameters	EC.PARGPCEC, EC.PARPAREC EC.RNGFRMEC, EC.RNGTOCEC EC.PARACCEC, EC.SPARIOEC EC.PARRVCEC, UG.UUTPGCUG UG.UUTPACUG, UG.UUTPIOUG UG.UUTPSOUG, UG.UUTPARUG UG.UUTPRFUG, UG.UUTPRTUG UG.UUTPRVUG, UN.SEUPGCUN UN.UTPAACUN, UN.UTPAIOUN UN.UTPAPAUN, UN.UTRGFRUN UN.UTPRRTUN, UN.UTPARVUN
285	Pass Through Price	EA.PASTHREA
286	Percentile	AA.PERCENAA, AC.MLPERCAC BD.PERCENBD
287	Performance Standards	CA.PRSTDACA, CA.PRSTDBCA CA.PRSTDCCA
288	Person Identifier	CD.SUBPIDCD, CK.SUBPIDCD GE.SUBPIDCD

MIL-STD-1388-2B
APPENDIX E

<u>DED</u>	<u>DATA ELEMENT TITLE</u>	<u>TABLE LOCATION</u>
289	Personnel Turnover Rate	XA.PRSTOVXA, XA.PRSTOMXA
290	Physical and Mental Requirements	GE.PAMENRGE
291	Physical Security/Pilferage Code	HA.PHYSECHA
292	Pilot Rework/Overhaul Candidate	BA.PREOVCSA
293	Precious Metal Indicator Code	HA.PMICODHA
294	Preparing Activity	EA.PREATYEA
295	Preservation Material Code	HF.PRSMATHF
296	Preventive Maintenance Checks and Services Indicator	CA.PMCSIDCA
297	Prior Item Provisioning List Item Sequence Number	HG.PIPLISHG
298	Procurement Quantity	JE.FIQPQTJE, JE.SQPQTYJE JE.TQPQTYJE, JE.FQPQTYJE
299	Production Lead Time	HA.PRDLDTA
300	Productivity Factor	XA.PROFACXA
301	Program Element	EA.PROELEEA
302	Program Parts Selection List	HA.PPSLSTHA
303	Program Support Inventory Control Point	EA.PSICPOEA
304	Proper Shipping Name	JA.PROPSNJA
305	Prorated Exhibit Line Item Number	HP.PROELIHP
306	Prorated Quantity	HP.PROQTYHP
307	Provisioning Contract Control Number	XC.PCCNUMXC
308	Provisioning List Category Code	HA.AAPLCCHA, HA.BBPLCCHA HA.CCPLCCHA, HA.DDPLCCHA HA.EEPLCCHA, HA.FFPLCCHA HA.GGPLCCHA, HA.HHPLCCHA HA.JJPLCCHA, HA.KKPLCCHA HA.LLPLCCHA, HA.MMPLCCHA
309	Provisioning List Item Sequence Number	XC.PLISNOXC, HG.PLISNOHG

MIL-STD-1388-2B
APPENDIX E

<u>DED</u>	<u>DATA ELEMENT TITLE</u>	<u>TABLE LOCATION</u>
310	Provisioning Nomenclature	HL.PROVNOHL
311	Provisioning Remarks	HI.REMARKHI
312	Provisioning System Identifier Code	HG.PROSICHG
313	Provisioning Technical Documentation Selection Code	HG.LLIPTDHG, HG.PPLPTDHG HG.SFPPTDHG, HG.CBLPTDHG HG.RILPTDHG, HG.ISLPTDHG HG.PCLPTDHG, HG.TTLPTDHG HG.SCPPTDHG, HG.ARAPTDHG HG.ARBPTDHG
314	Provisioning Unit of Measure/ Issue Price Code (PUC)	HD.PROUIPHD, HE.PROUMPHE
315	Qualitative and Quantitative Maintainability Requirements: Nuclear Hardened Characteristics, Fail Safe, Environmental, etc.	BB.RAMNARBB, BB.RAMCNABB (D)
316	Quantity Per Assembly	XC.QTYASYXC, HG.QTYASYHG
317	Quantity Per End Item	XC.QTYPEIXC, HG.QTYPEIHG
318	Quantity Per Figure	HK.QTYFIGHK
319	Quantity Per Task	CG.SQTYTKCG, CI.PQTYTKCI
320	Quantity Per Test	EM.QTYTSTEM
321	Quantity Per Unit Pack	HF.QTYUPKHF
322	Quantity Procured	HP.QTYPROHP
323	Quantity Shipped	HP.QTYSHPHP
324	Quantity Skill Specialty Code Available	AE.QTYAVAAE
325	Rail Transportation Country	JB.RAILTCJB
326	Rail Use	JB.RAILUSJB
327	Reason for Supersedure/Deletion	EK.REASUPEK
328	Recommended Initial System Stock Buy	HG.RISSBUHG
329	Recommended Minimum System Stock Level	HG.RMSSLIHG

MIL-STD-1388-2B
APPENDIX E

<u>DED</u>	<u>DATA ELEMENT TITLE</u>	<u>TABLE LOCATION</u>
330	Recommended Rank/Rate/Pay Plan/ Grade	GB.RPPCIVGB, GB.RPPMILGB
331	Recommended Tender Load List Quantity	HG.RTLLQTHG
332	Recurring	EA.RCURCSEA
333	Recurring Bin Cost	XA.RCBINXA
334	Recurring Cataloging Cost	XA.RCCATCXA
335	Reference Designation	HJ.REFDESHJ
336	Reference Designation Code	HJ.RDCODEHJ
337	Reference Number	AH.IOREFNAH, CG.TSREFNCG CI.PROREFCI, EA.SEREFNEA EB.SEREFNEA, EC.SEREFNEA ED.SEREFNEA, EE.SEREFNEA EF.SEREFNEA, EG.SEREFNEA EH.SEREFNEA, EI.SEREFNEA EJ.SEREFNEA, EK.SEREFNEA EK.SPRREFEK, EL.SEREFNEA EM.SEREFNEA, EM.SREFNOEM UB.SEREFNEA, UC.OTPREFUC UD.SEREFNEA, UD.OTPREFUC UE.OTPREFUC, UE.TPIREFUE UG.SEREFNEA, UH.PROREFCI UH.SEREFNEA, UI.AIDREFUI UJ.SEREFNEA, UJ.AIDREFUI UK.ATEREFUK, UL.SEREFNEA UL.ATEREFUK, UM.SUTREFUM UN.TGSREFUN, UN.SUTREFUM HA.REFNUMHA, HB.REFNUMHB HC.REFNUMHC, HD.REFNUMHA HE.REFNUMHA, HF.REFNUMHA HG.REFNUMHA, HH.REFNUMHA HI.REFNUMHA, HJ.REFNUMHA HK.REFNUMHA, HL.REFNUMHA HM.REFNUMHA, HN.REFNUMHN HO.REFNUMHO, HP.REFNUMHA HQ.REFNUMHA, HR.REFNUMHO
338	Reference Number Category Code	HA.REFNCCHA, HB.ADRNCCHB
339	Reference Number Variation Code	HA.REFNVCHA, HB.ADRNVCHB
340	Regulatory Requirements	JF.TRANARJF, JF.TRANCDJF (D)

MIL-STD-1388-2B
APPENDIX E

<u>DED</u>	<u>DATA ELEMENT TITLE</u>	<u>TABLE LOCATION</u>
341	Reliability Availability Maintainability Characteristics Narrative Code	BB.RAMCNABB
342	Reliability Availability Maintainability Indicator	XB.RAMINDXB
343	Reliability Centered Maintenance Age Exploration	BG.FMNNARBG, BG.FMNCNABG (J)
344	Reliability Centered Maintenance Logic Results	BF.RCMR01BF, BF.RCMR02BF BF.RCMR03BF, BF.RCMR04BF BF.RCMR05BF, BF.RCMR06BF BF.RCMR07BF, BF.RCMR08BF BF.RCMR09BF, BF.RCMR10BF BF.RCMR11BF, BF.RCMR12BF BF.RCMR13BF, BF.RCMR14BF BF.RCMR15BF, BF.RCMR16BF BF.RCMR17BF, BF.RCMR18BF BF.RCMR19BF, BF.RCMR20BF BF.RCMR21BF, BF.RCMR22BF BF.RCMR23BF, BF.RCMR24BF BF.RCMR25BF
345	Reliability Centered Maintenance Logic Utilized	AA.RCMLOGAA
346	Reliability Centered Maintenance Reasoning	BG.FMNNARBG, BG.FMNCNABG (K)
347	Reliability/Maintainability Indicator Code	BD.RAMINDBD, BE.RAMINDBD
348	Remain-In-Place Indicator	HG.REMIPIHG
349	Remarks Reference Code	CE.TSKRRCCE, CF.TSKRRCCE
350	Repair Cycle Time	HG.ORCTOOHG, HG.FRCTFFHG HG.HRCTHHHG, HG.LRCTLLHG HG.DRCTDDHG, HG.CONRCTHG
351	Repair Survival Rate	HG.REPSURHG
352	Repair Work Space Cost	AI.RPWSCSAI
353	Replaced or Superseding Provisioning List Item Sequence Number	HP.RSPLISHP
354	Replaced or Superseding Provisioning List Item Sequence Number Indicator	HP.RSPINDHP

MIL-STD-1388-2B
APPENDIX E

<u>DED</u>	<u>DATA ELEMENT TITLE</u>	<u>TABLE LOCATION</u>
355	Replacement Task Distribution	HG.ORTDOOHG, HG.FRTDFFHG HG.HRTDHHHG, HG.LRTDLLHG HG.DRTDDDHG
356	Reportable Item Control Code	EA.SERICCEA
357	Required Days of Stock	AI.RQDSTKAI
358	Requirements for	CA.FTRNRQCA, CA.TRNRQCCA CA.TSEREQCA
359	Retail Stockage Criteria	XA.RESTCRXA
360	Revision	EF.SRDREVEF, EG.SRDREVEF EH.SRDREVEF, FA.FADREVFA
361	Revolving Assets	EA.REVASSEA
362	Safety Hazard Severity Code	BI.FMSHSCBI, BK.FMSHSCBK
363	Safety Level	XA.SAFLVLXA
364	Same As Provisioning List Item Sequence Number	HG.SAPLISHG
365	Scope	EJ.DDCCSCEJ, EL.IRCSOEL
366	Sectionalization Identification	JA.SECTIDJA
367	Sectionalized Item Transportation Indicator	XB.SECITMXB
368	Sectionalized Remarks	JF.TRANARJF, JF.TRANCDJF (G)
369	Security Clearance	BA.SECLEBA, GB.SCRSSCGB
370	Self Test	EA.SLFTSTEA, UE.TPISTSUE
371	Sensors or Transducers	EA.SENTRAEA
372	Sequential Subtask Description	CC.SUBNARCC
373	Serial Number	XD.FRSNUMXD, XD.TOSNUMXD XE.FRSNUMXE, XE.TOSNUMXE HN.FRSNUMHN, HN.TOSNUMHN
374	Serial Number Effectivity	HQ.FMSRNOHQ, HQ.TOSRNOHQ
375	Serial Number Usable On Code	XD.SNUUOCXD
376	Service Designator Code	AA.SERDESAA, AB.SERDESAA AC.SERDESAA, AD.SERDESAA AE.SERDESAA, AF.SERDESAA

MIL-STD-1388-2B
APPENDIX E

<u>DED</u>	<u>DATA ELEMENT TITLE</u>	<u>TABLE LOCATION</u>
		AI.SERDESAI, EA.SERDESEA EA.USESEREA
377	Shelf Life	HA.SHLIFEHA
378	Shelf Life Action Code	HA.SLACTNHA
379	Ship Time	AJ.TIMESHAJ
380	Shipping Configuration	JB.SHPCONJB
381	Shipping Weight (Empty/Loaded)	JC.SHWEEMJC, JC.SHWELDJC
382	Shock and Vibration Remarks	JF.TRANARJF, JF.TRANCDJF (A)
383	Sketch	EA.SKETCHEA
384	Skid Area	JC.SDSICGJC
385	Skid Remarks	JD.WHTRLOJD, JD.TREINCJD (B)
386	Skill Level Code	GA.SKLVCDGA, GB.MDSCLCGB
387	Skill Specialty Code	AE.SKSPCDGA, CD.SKSPCDGA EA.SSCOPREA, GA.SKSPCDGA GB.SKSPCDGA
388	Skill Specialty Evaluation Code	CD.SSECDECD
389	Source, Maintenance and Recoverability Code	EA.SMRCSEEA, HG.SMRCODHG
390	Spare Factor	EA.SPRFACEA
391	Spares Acquisition Integrated with Production	HA.SAIPCDHA
392	Special Maintenance Item Code	HA.SMAINCHA
393	Special Management	EA.SPMGNTEA
394	Special Marking Code	HF.SPEMRKHF
395	Special Material Content Code	HA.SPMACCHA
396	Special Packaging Instruction Number	HF.SPINUMHF
397	Special Packaging Instruction Number Revision	HF.SPIREVHF
398	Specialized Service and Equipment Requirements	JF.TRANARJF, JF.TRANCDJF (F)

MIL-STD-1388-2B
APPENDIX E

<u>DED</u>	<u>DATA ELEMENT TITLE</u>	<u>TABLE LOCATION</u>
399	Specific Authorization	ED.ACTNAMED, ED.TYPACTED ED.NUMACTED, ED.SEQTYAED
400	Speed	JA.SPSPEDJA
401	Standard Interservice Agency Serial Control Number	EA.SIASCNEA
402	Standards For Comparison	UC.OTPSFCUC
403	Standby Time	AB.OSTBTIAB, BE.STABYTBE
404	Status	EF.STATUSSEF
405	Storage Dimensions	EA.STOHGTEA, EA.STOLENEA EA.STOWDTEA
406	Storage Weight	EA.STOWGTEA
407	Subtask Number	CB.SUBNUMCB, CB.RFDSUBCB CC.SUBNUMCB, CD.SUBNUMCB CK.SUBNUMCB, GE.SUBNUMCB
408	Supersedure Type	EK.SUTYPEEK
409	Supplemental Packaging Data	HF.SUPPKDHF
410	Support Concept	BA.SUPCONBA
411	Support Equipment Explanation	EE.SEQNAREE, EE.SENARCEE (G)
412	Support Equipment Full Item Name	EA.FLITNMEA
413	Support Equipment Grouping	EA.SEGRCDEA
414	Support Equipment Narrative Code	EE.SENARCEE
415	Support Equipment Non- Proliferation Effort	EE.SEQNAREE, EE.SENARCEE (C)
416	Support Equipment Recommendation Data Number	EF.SERDNOEF, EG.SERDNOEF EH.SERDNOEF, EK.SUSRNOEK UC.OTPSRDUC, UE.TPISRDU UI.AIDSRDUI
417	Support Equipment Recommendation Data Revision Remarks	EG.REVREMEG
418	Support Equipment Required	EA.SEREQDEA
419	Support Equipment Shipping Dimensions	EA.SESHPHEA, EA.SESHPLEA EA.SESHPWEA

MIL-STD-1388-2B
APPENDIX E

<u>DED</u>	<u>DATA ELEMENT TITLE</u>	<u>TABLE LOCATION</u>
420	Support Equipment Shipping Weight	EA.SESHWTEA
421	Support of Support Equipment Cost Factor	XA.SECSFCXA
422	Suppression Indicator Code	HG.SUPINDHG
423	System/End Item Identifier	XB.SYSIDNXB, HG.PSYSIDHG
424	System/End Item Narrative Code	AK.SEINCDKA
425	System Redesign/Logistics Considerations Code	BC.LOCOCOBC
426	System Redesign/Logistics Considerations, Recommendations, Disposition, Results	BG.FMNNARBG, BG.FMNCNABG(I) BG.FMNCNABG(L), BC.LOGNARBC
427	Task Code	BH.TTASKCBH, CA.TASKCDCA CA.REFTSKCA, CB.TASKCDCA CB.RFDTCDCA, CC.TASKCDCA CD.TASKCDCA, CF.TASKCDCA CG.TASKCDCA, CH.TASKCDCA CK.TASKCDCA, FE.TASKCDCA GE.TASKCDCA
428	Task Condition	CA.TCONDACA, CA.TCONDBCA CA.TCONDCCA
429	Task Criticality	CA.TSKCRCCA
430	Task Frequency	CA.TSKFRQCA
431	Task Identification	CA.TASKIDCA, CB.SUBTIDCB
432	Task Remarks	CE.TSKREMCE
433	Task Type	BH.TATYPEBH
434	Technical Data Package	UE.TPITDPUE
435	Technical Evaluation Priority Code	EA.TECEVLEA
436	Technical Manual Change Number	HK.TMCHGNHK
437	Technical Manual Code	XI.TMCOEXI, CH.TMCOEXI HJ.TMCOEXI, HK.TMCOEXI HL.TMCOEXI
438	Technical Manual Functional Group Code	XB.TMFGCDXB, HK.TMFGCDHK

MIL-STD-1388-2B
APPENDIX E

<u>DED</u>	<u>DATA ELEMENT TITLE</u>	<u>TABLE LOCATION</u>
439	Technical Manual Indenture Code	HK.TMINDCHK
440	Technical Manual Number	XI.TMNUMBXI, AH.IOITNMAH
441	Technical Manual Required Code(s)	EA.TMRQCDEA
442	Test Accuracy Ratio	UG.UUTPTAUG, UG.UUTPTDUG UN.UTPATAUN, UN.UTPATDUN
443	Test Language	EA.TSTLNGEA
444	Test Measurement and Diagnostic Equipment Register Code	EA.TMDERCEA
445	Test Measurement and Diagnostic Equipment Register Index Number	EA.TMDERIEA
446	Test Points	EA.TSTPTSEA
447	Test Requirements Document Indicator	UH.UUTFTDUH
448	Test Requirements Document Number	UA.UTTRDNA, UM.TRDNUMUM
449	Test Score	GB.SSCTESGB
450	Text Sequencing Code	AF.TEXSEQAF, AK.TEXSEQAK BB.TEXSEQBB, BC.TEXSEQBC BG.TEXSEQBG, BJ.TEXSEQBJ CC.TEXSEQCC, CK.TSFROMCK CK.TEXTTOCK, EE.TEXSEQEE EG.TEXSEQEG, UF.TEXSEQUF FB.TEXSEQFB, FC.TEXSEQFC FD.TEXSEQFD, GC.TEXSEQGC GE.TEXSEQGE, HI.TEXSEQHI HL.TEXSEQHL, JD.TEXSEQJD JF.TEXSEQJF
451	Theater of Operation	JA.TRCHTHJA
452	Total Item Changes	HP.TOTICHHP
453	Total Quantity Recommended	HG.TOTQTYHG
454	Total Systems Supported	AA.TOSYSUAA
455	Towing Speed	JA.TWSPEDJA
456	Tracked Ground Contact Pressure	JC.TRGRPRJC
457	Tracked Pad Shoe Area	JC.TRPSARJC

MIL-STD-1388-2B
APPENDIX E

<u>DED</u>	<u>DATA ELEMENT TITLE</u>	<u>TABLE LOCATION</u>
458	Tracked Pads Touching	JC.TRNUPTJC
459	Tracked Road Wheel Weight	JC.TRRWWTJC
460	Training Cost	GA.TRNCOSGA
461	Training Location Rationale	CA.TRNLOCCA
462	Training Rationale	CA.TRNRATCA
463	Training Recommendation	CA.TRNRECCA
464	Transportation Characteristics Mode Type	JB.TRCHMTJB
465	Transportation Characteristics Number	JB.TRANCNJB
466	Transportation Cost	XA.TRNCSTXA
467	Transportation End Item Indicator	XC.TRASEIXC
468	Transportation Indicator	JA.TRNINDJA
469	Transportation Item Designator (Ship, Literage, Aircraft, Helicopter)	JB.TRITDRJB
470	Transportation Narrative Code	JF.TRANCDJF
471	Transportation Projection Remarks	JF.TRANARJF, JF.TRANCDJF (C)
472	Transportation Remarks (Handling, Towing, Air Drop, Self-Propelled)	JF.TRANARJF, JF.TRANCDJF (E)
473	Transported Configuration Number	JC.TRCONMJC, JD.TRCONMJC
474	Transported End Item Narrative Code	JD.TREINCJD
475	Transported Other Equipment	JD.WHTRLOJD, JD.TREINCJD (E)
476	Transport To and From	JF.TRANARJF, JF.TRANCDJF (H)
477	Turning Information	JD.WHTRLOJD, JD.TREINCJD (C)
478	Type Acquisition	XA.WSTYAQXA
479	Type Classification	EA.TYPCLSEA
480	Type Equipment Code	EA.TYPEEQEA
481	Type of Change Code	XC.TOCCODXC, HG.TOCCODHG

MIL-STD-1388-2B
APPENDIX E

<u>DED</u>	<u>DATA ELEMENT TITLE</u>	<u>TABLE LOCATION</u>
482	Type of Construction	FD.NMFNARFD, FD.NMFCDFD (H)
483	Type of Facility	FA.FACTYPFA, FB.FACTYPFA FC.FACTYPFC, FD.FACTYPFD
484	Type of Supply System Code	XA.TSSCODXA
485	Type of Unit of Measure/ Issue Price Code	HD.TUIPRCHD, HE.TUMPRCHE
486	Unit Container Code	HF.UNICONHF
487	Unit Container Level	HF.UCLEVLHF
488	Unit of Issue	HA.UNITISHA
489	Unit of Issue Conversion Factor	HA.UICONVHA
490	Unit of Issue Price	HD.UIPRICHD
491	Unit of Measure	CG.SQTKUMCG, CI.PQTKUMCI EA.LWHOUMEA, EA.WGTOUMEA EA.LWHSUMEA, EA.WGTSUMEA EA.UMSHIPEA, EA.UMSEWTEA FA.FAARUMFA, FA.CONUOMFA HA.UNITMSHA, JC.TPSAUMJC JC.SKADUMJC
492	Unit of Measure Price	HE.UMPRICHE, FA.FACNCOFA
493	Unit Pack Cube	HF.UNPKCUHF
494	Unit Pack Size	HF.LENUPKHF, HF.WIDUPKHF HF.DEPUPKHF
495	Unit Pack Weight	HF.UNPKWTHF
496	Unit Size	HA.ULENGTHA, HA.UWIDTHHA HA.UHEIGHTHA
497	Unit Weight	HA.UWEIGHTHA
498	Unit Under Test Explanation	UF.UTEXPLUF
499	Unscheduled Maintenance	AC.MLUMETAC, AC.MLUMMHAC
500	Unusual and Special Transportation Requirements	JF.TRANARJF, JF.TRANCDJF (K)
501	Usable On Code	XC.UOCSEIXC,
502	Utilities Requirements	FD.NMFNARFD, FD.NMFCDFD (I)

MIL-STD-1388-2B
APPENDIX E

<u>DED</u>	<u>DATA ELEMENT TITLE</u>	<u>TABLE LOCATION</u>
503	Utilization Ratio	AE.UTRATIAE
504	Venting and Protective Clothing Requirements	JF.TRANARJF, JF.TRANCDJF (L)
505	Wearout Life	BA.WEOULIBA
506	Wheeled Axle and Suspension Requirements	JD.WHTRLOJD, JD.TREINCJD (D)
507	Wheeled Inflation Pressure	JC.WHINPRJC
508	Wheeled Number of Plies	JC.WHNUPLJC
509	Wheeled Number of Tires	JC.WHNUTIJC
510	Wheeled Tire Load Rating	JC.WHTLDRJC
511	Wheeled Tire Requirements	JD.WHTRLOJD, JD.TREINCJD (A)
512	Wheeled Tire Size	JC.WHTIFTJC
513	Wheeled Weight Ratings	JC.WHWERAJC
514	Work Area Code	CB.SUBWACCB
515	Work Package Reference	UA.UTWPRFUA, UM.WKPKRFUM
516	Work Unit Code	HG.WRKUCDHG
517	Wrapping Material	HF.WRAPMTHF
518	Year	EA.YRFLDGEA

MIL-STD-1388-2B
APPENDIX E

APPENDIX E - SECTION 2

LISTING OF DATA ELEMENT CODES

<u>CODE</u>	<u>DED</u>	<u>DATA ELEMENT TITLE (ROLE NAMED)</u>
- A -		
AAEERHGD	026	ASVAB APTITUDE ELEMENT EXPECTED RANGE HIGH
AAEERLGD	026	ASVAB APTITUDE ELEMENT EXPECTED RANGE LOW
AAELPHGD	026	ASVAB APTITUDE ELEMENT LOWEST PERCENT HIGH
AAELPLGD	026	ASVAB APTITUDE ELEMENT LOWEST PERCENT LOW
AAEXRHGB	026	ASVAB AFQT EXPECTED RANGE HIGH
AAEXRLGB	026	ASVAB AFQT EXPECTED RANGE LOW
AALPRHGB	026	ASVAB AFQT LOWEST PERCENT HIGH
AALPRLGB	026	ASVAB AFQT LOWEST PERCENT LOW
AAPLCCHA	308	GOVERNMENT FURNISHED PROVISIONING LIST CATEGORY CODE
ABAFQTGB	026	ASVAB AFQT SCORE
ACHAVABD	001	ACHIEVED AVAILABILITY
ACQMETHA	003	ACQUISITION METHOD CODE
ACTNAMED	399	ACTIVITY NAME LOCATION
ACTNSNHA	253	NSN ACTIVITY CODE
ADCAGEHB	046	ARN CAGE CODE
ADDLTMXA	014	ADMINISTRATIVE LEAD TIME
ADDREFHB	006	ADDITIONAL REFERENCE NUMBER
ADPEQPHA	027	AUTOMATIC DATA PROCESSING EQUIPMENT CODE
ADQCOFEA	002	ACQUISITION DECISION OFFICE
ADRNCCHB	338	ARN REFERENCE NUMBER CATEGORY CODE
ADRNVCHE	339	ARN REFERENCE NUMBER VARIATION CODE
AIDCAGUI	046	ADAPTER INTERCONNECTOR DEVICE (AID) CAGE CODE
AIDCUTUI	048	COMMON UNIT UNDER TEST
AIDREFUI	337	AID REFERENCE NUMBER
AIDRQDEA	005	ADAPTER/INTERCONNECTION DEVICE REQUIRED
AIDSRDUI	416	AID SUPPORT EQUIPMENT RECOMMENDATION DATA NUMBER
AIDUCNUI	025	AID APPORTIONED UNIT COST RECURRING
AIDUCRUI	025	AID APPORTIONED UNIT COST NONRECURRING
ALCSEIHN	019	S/N PROVISIONING SYSTEM/EI ALC
ALCSEIHO	019	UOC PROVISIONING SYSTEM/EI ALC
ALCSEIXE	019	S/N SYSTEM/EI ALTERNATE LCN CODE
ALCSEIXF	019	UOC SYSTEM/EI ALC
ALDCNMEB	016	ALLOWANCE DOCUMENT NUMBER
ALDNDSEB	015	ALLOCATION DESIGN DESCRIPTION
ALDTXXBE	013	ADMINISTRATIVE AND LOGISTICS DELAY TIME
ALEXRNEB	015	ALLOCATION EXTENDED RANGE
ALIQTYHG	018	ALLOWANCE ITEM QUANTITY
ALLOWCHG	017	ALLOWANCE ITEM CODE
ALLVCDEB	015	ALLOCATION LAND OR VESSEL CODE
ALMLVLEB	015	ALLOCATION MAINTENANCE LEVEL FUNCTION
ALORG1EB	015	ALLOWABLE RANGE 1
ALORG2EB	015	ALLOWABLE RANGE 2
ALORG3EB	015	ALLOWABLE RANGE 3
ALORG4EB	015	ALLOWABLE RANGE 4
ALORG5EB	015	ALLOWABLE RANGE 5
ALORG6EB	015	ALLOWABLE RANGE 6
ALORG7EB	015	ALLOWABLE RANGE 7

MIL-STD-1388-2B
APPENDIX E

<u>CODE</u>	<u>DED</u>	<u>DATA ELEMENT TITLE (ROLE NAMED)</u>
ALORG8EB	015	ALLOWABLE RANGE 8
ALORG9EB	015	ALLOWABLE RANGE 9
ALRG10EB	015	ALLOWABLE RANGE 10
ALSTIDEB	015	ALLOCATION STATION IDENTIFICATION CODE
ALTFSCHEH	253	ALTERNATE NATIONAL STOCK NUMBER (NSN) FEDERAL SUPPLY CLASSIFICATION
ALTLCNBH	019	FMT ALTERNATE LCN CODE
ALTLCNHN	019	S/N PROVISIONING ITEM ALTERNATE LCN CODE (ALC)
ALTLCNHO	019	UOC PROVISIONING ALTERNATE LCN CODE (ALC)
ALTLCNXB	019	ALTERNATE LCN CODE
ALTLCNXE	019	S/N ITEM ALTERNATE LCN CODE
ALTLCNXF	019	UOC ITEM ALC
ALTNIIEH	253	ALTERNATE NSN NATIONAL ITEM IDENTIFICATION NUMBER
AMSUFCHA	004	ACQUISITION METHOD SUFFIX CODE
ANNOMIAB	021	ANNUAL NUMBER OF MISSIONS
ANOPDAAB	022	ANNUAL OPERATING DAYS
ANOPREAG	023	ANNUAL OPERATING REQUIREMENTS
ANOPTIAB	024	ANNUAL OPERATING TIME
AORALCCA	019	AOR ALC
AORLCNCA	199	ANNUAL OPERATING REQUIREMENT (AOR) LCN
AORMSBCA	238	AOR MEASUREMENT BASE
AORTYPCA	203	AOR LCN TYPE
ARAPTDHG	313	AS REQUIRED LIST A (PTD)
ARBPTDHG	313	AS REQUIRED LIST B (PTD)
ASVAPEGD	026	ASVAB APTITUDE ELEMENT
ATECAGUK	046	ATE CAGE CODE
ATEGDSUK	149	ATE GOVERNMENT DESIGNATOR
ATEREFUK	337	AUTOMATIC TEST EQUIPMENT (ATE) REFERENCE NUMBER
AVAIMHAE	028	AVAILABLE MAN-HOUR

- B -

BBPLCCHA	308	INTERIM SUPPORT ITEMS PLCC
BDLPGABA	032	BUILT IN TEST DETECTABILITY LEVEL PERCENTAGE PER GROUP 1
BDLPGBBA	032	BUILT IN TEST DETECTABILITY LEVEL PERCENTAGE PER GROUP 2
BITNDPBA	031	BUILT IN TEST CANNOT DUPLICATE PERCENTAGE
BITROPBA	033	BUILT IN TEST RETEST OK PERCENT
BOICTRHM	030	BASIS OF ISSUE CONTROL

- C -

CACITYXH	047	CAGE CITY
CADMTDHG	214	CONDEMNED AT DEPOT MTD
CAGECDHB	046	ARN ITEM CAGE CODE
CAGECDHC	046	ITEM CAGE CODE
CAGECDHN	046	S/N PROVISIONING CAGE CODE
CAGECDHO	046	UOC PROVISIONING CAGE CODE
CAGECDXH	046	COMMERCIAL AND GOVERNMENT ENTITY (CAGE) CODE
CALINTEA	037	CALIBRATION INTERVAL
CALITMEA	038	CALIBRATION ITEM
CALPROEC	039	CALIBRATION PROCEDURE
CALRQDEA	040	CALIBRATION REQUIRED
CALSTDEA	041	CALIBRATION STANDARD
CALTIMEA	042	CALIBRATION TIME

MIL-STD-1388-2B
APPENDIX E

<u>CODE</u>	<u>DED</u>	<u>DATA ELEMENT TITLE (ROLE NAMED)</u>
CANAMEXH	047	CAGE NAME
CANATNXH	047	CAGE NATION
CANUMBHP	043	CHANGE AUTHORITY NUMBER
CAPOZOXH	047	CAGE POSTAL ZONE
CASTATXH	047	CAGE STATE
CASTREXH	047	CAGE STREET
CBDMTDHG	214	CONDEMNED BELOW DEPOT MTD
CBLPTDHG	313	COMMON AND BULK ITEMS LIST (PTD)
CCPLCCHA	308	LONG LEAD ITEM PLCC
CDPROCHF	045	CLEANING AND DRYING PROCEDURES
CFEGFEEA	056	CONTRACTOR FURNISHED EQUIPMENT/GOVERNMENT FURNISHED EQUIPMENT
CMRSRCEA	035	CALIBRATION MEASUREMENT REQUIREMENT SUMMARY RECOMMENDED
CNTRECEJ	057	DDCC CONTRACTOR RECOMMENDED
CNTRNOEA	055	SUPPORT EQUIPMENT CONTRACT NUMBER
COGNSNHA	253	NSN COGNIZANCE CODE
CONLENJB	053	CONTAINER LENGTH
CONNSNHF	253	CONTAINER NATIONAL STOCK NUMBER
CONNUMJA	055	CONTRACT NUMBER
CONRCTHG	350	CONTRACTOR RCT
CONRECEL	057	IRCC CONTRACTOR RECOMMENDED
CONTNOXA	055	SYSTEM END ITEM CONTRACT NUMBER
CONTYPJB	054	CONTAINER TYPE
CONUOMFA	491	CONSTRUCTION UNIT OF MEASURE
CONVFABA	059	CONVERSION FACTOR
CREANGJC	063	CREST ANGLE
CREWSZAA	064	CREW SIZE
CRITCDHA	066	CRITICALITY CODE
CRITITHA	065	CRITICAL ITEM CODE
CSPRRQXA	062	COST PER REQUISITION
CSREORXA	061	COST PER REORDER
CTCAGEHC	046	CTIC CAGE CODE
CTDLTMXA	052	CONTRACT TEAM DELAY TIME
CTICODHA	058	CONTRACTOR TECHNICAL INFORMATION CODE
CURPRCHD	051	UI PRICE CONCURRENT PRODUCTION CODE
CURPRCHE	051	UM PRICE CONCURRENT PRODUCTION CODE
CUSHMAHF	067	CUSHIONING AND DUNNAGE MATERIAL
CUSTCDEA	069	CUSTODY CODE
CUSTHIHF	068	CUSHIONING THICKNESS

- D -

DATASCHG	070	DATA STATUS CODE
DATFADEA	071	DATE OF FIRST ARTICLE DELIVERY
DDCCSCEJ	365	DDCC SCOPE
DDPLCCHA	308	TOOLS AND TEST EQUIPMENT PLCC
DEGPROHF	074	DEGREE OF PROTECTION CODE
DELSCHJA	075	DELIVERY SCHEDULE
DEMILCXA	077	DEMILITARIZATION COST
DEMILIHA	076	DEMILITARIZATION CODE
DEPUPKHF	494	UNIT PACK DEPTH
DINMETAD	280	DAILY INSPECTION MEAN ELAPSED TIME
DINMMHAD	280	DAILY INSPECTION MEAN MAN-HOURS
DISCNTXA	083	DISCOUNT RATE

MIL-STD-1388-2B
APPENDIX E

<u>CODE</u>	<u>DED</u>	<u>DATA ELEMENT TITLE (ROLE NAMED)</u>
DLSCRCHA	073	DEFENSE LOGISTICS SERVICES CENTER SCREENING REQUIREMENT CODE
DMTDDDHG	214	DEPOT/SHIPYARD MTD
DOCAVCHA	086	DOCUMENT AVAILABILITY CODE
DOCIDCHA	087	DOCUMENT IDENTIFIER CODE
DPRNRSGB	092	DUTY POSITION REQUIRING A NEW OR REVISED SKILL
DRCLASFA	088	FACILITY DRAWING CLASSIFICATION
DRCTDDHG	350	DEPOT/SHIPYARD RCT
DRPONEHG	081	DESIGNATED REWORK POINT ONE
DRPTWOHG	081	DESIGNATED REWORK POINT TWO
DRTDDDHG	355	DEPOT SHIPYARD RTD
DRWCLSEA	088	SUPPORT EQUIPMENT DRAWING CLASSIFICATION
DSNDATEJ	079	DESIGN DATA CATEGORY CODE
DSNPRCEA	080	DESIGN DATA PRICE
DTGVDSEF	071	SERD DATE OF GOVERNMENT DISPOSITION
DTRVSBEF	071	SERD DATE OF REVISION SUBMISSION
DUTIESCJ	090	DUTY
DUTYCDCJ	091	DUTY CODE

- E -

ECOANLEA	093	ECONOMIC ANALYSIS
EEPLCCHA	308	COMMON AND BULK ITEM PLCC
EFMMBBBF	238	ENGINEERING FAILURE MODE MEAN TIME BETWEEN FAILURE MEASUREMENT BASE
EFMTBFBF	097	ENGINEERING FAILURE MODE MEAN TIME BETWEEN FAILURE
EIACODXA	096	END ITEM ACRONYM CODE
ELEMNTCC	095	ELEMENT INDICATOR
ENDARTEA	179	END ARTICLE ITEM DESIGNATOR
ENHATCJA	098	ENVIRONMENTAL HANDLING AND TRANSPORTATION INDICATOR
EOILINJB	104	EXTERNAL OR INTERNAL LOAD INDICATOR
ESSALVXA	102	ESTIMATED SALVAGE VALUE
ESSCODHG	100	ESSENTIALITY CODE
ESTPRCEJ	101	DDCC ESTIMATED PRICE
ESTPRCEL	101	IRCC ESTIMATED PRICE
EXUNPREA	103	EXTENDED UNIT PRICE

- F -

FAAREAFA	026	FACILITY AREA
FAARUMFA	491	FACILITY AREA UNIT OF MEASURE
FABNARFC	---	BASELINE FACILITY NARRATIVE
FACCCDFA	115	FACILITY CATEGORY CODE
FACCCDFC	115	BASELINE FACILITY CATEGORY CODE
FACCCDFD	115	NEW OR MODIFIED FACILITY CATEGORY CODE
FACCLAFA	116	FACILITY CLASS
FACNAMFA	118	FACILITY NAME
FACNAMFC	118	BASELINE FACILITY NAME
FACNAMFD	118	NEW OR MODIFIED FACILITY NAME
FACNARFB	---	FACILITY NARRATIVE
FACTYPFA	483	FACILITY TYPE
FACTYPFC	483	BASELINE FACILITY TYPE
FACTYPFD	483	NEW OR MODIFIED FACILITY TYPE
FACRNUBI	133	FAILURE MODE CRITICALITY NUMBER
FADNUMFA	089	FACILITY DRAWING NUMBER
FADREVFA	360	FACILITY DRAWING REVISION

MIL-STD-1388-2B
APPENDIX E

<u>CODE</u>	<u>DED</u>	<u>DATA ELEMENT TITLE (ROLE NAMED)</u>
FAILRTBD	140	FAILURE RATE
FALCNCXG	019	FUNCTIONAL EI ALC
FAMGRPEA	142	FAMILY GROUP
FAMOINBF	134	FAILURE MODE INDICATOR
FARAMBBB	238	FAILURE RATE MEASUREMENT BASE
FBNACDFC	113	BASELINE FACILITY NARRATIVE CODE
FEPROBBI	130	FAILURE EFFECT PROBABILITY
FFPLCCHA	308	REPAIRABLE ITEMS PLCC
FIAMBABA	143	FAULT ISOLATION AMBIGUITY GROUP 1
FIAMBBBA	143	FAULT ISOLATION AMBIGUITY GROUP 2
FIGNUMHK	144	FIGURE NUMBER
FIPFGABA	143	FAULT ISOLATION PERCENT FAILURE GROUP 1
FIPFGBBA	143	FAULT ISOLATION PERCENT FAILURE GROUP 2
FIQPQTJE	298	FIRST QUARTER PROCUREMENT QUANTITY
FISCYRHD	145	UI PRICE FISCAL YEAR
FISCYRHE	145	UM PRICE FISCAL YEAR
FLCNTYXG	203	FUNCTIONAL SYSTEM/EI LCN TYPE
FLITNMEA	412	SUPPORT EQUIPMENT FULL ITEM NAME
FLSACNXG	199	FUNCTIONAL SYSTEM/EI LCN
FMCLASBF	132	FAILURE MODE CLASSIFICATION
FMCNARBJ	---	FAILURE MODE INDICATOR MISSION PHASE CHARACTERISTICS NARRATIVE
FMMPCNB	135	FAILURE MODE INDICATOR MISSION PHASE CHARACTERISTICS NARRATIVE CODE
FMNCNABG	131	FAILURE MODE AND RCM NARRATIVE CODE
FMNNARBG	---	FAILURE MODE NARRATIVE
FMOPTIBI	269	OPERATING TIME
FMOTMBBI	238	OPERATING TIME MEASUREMENT BASE
FMRATOFB	136	FAILURE MODE RATIO
FMSHSCBI	362	SAFETY HAZARD SEVERITY CODE
FMSHSCBK	362	RAM SAFETY HAZARD SEVERITY CODE
FMSRNOHQ	374	SERIAL NUMBER EFFECTIVITY FROM
FMTDFFHG	214	INTERMEDIATE/DIRECT SUPPORT MTD
FNCODEFB	119	FACILITY NARRATIVE CODE
FPROBLBI	139	FAILURE PROBABILITY LEVEL
FQPQTYJE	298	FOURTH QUARTER PROCUREMENT QUANTITY
FRCLASJB	146	FREIGHT CLASSIFICATION
FRCTFFHG	350	INTERMEDIATE/DIRECT SUPPORT RCT
FRDATABA	141	FAILURE RATE DATA SOURCE
FRSNUMHN	373	S/N PROVISIONING SERIAL NUMBER FROM
FRSNUMXD	373	SERIAL NUMBER FROM
FRSNUMXE	373	S/N SERIAL NUMBER FROM
FRTDFFHG	355	INTERMEDIATE/DIRECT SUPPORT RTD
FSCNSNHA	253	NSN FEDERAL SUPPLY CLASSIFICATION
FTRNRQCA	358	FACILITY REQUIREMENT CODE

- G -

GENECDEA	148	GENERIC CODE
GFAEIDEM	179	SYSTEM EQUIPMENT ITEM DESIGNATOR
GGPLCCHA	308	INTERIM RELEASED ITEM PLCC
GOVDESEA	149	GOVERNMENT DESIGNATOR
GOVRQDEJ	150	DDCC GOVERNMENT REQUIRED
GOVRQDEL	150	IRCC GOVERNMENT REQUIRED

MIL-STD-1388-2B
APPENDIX E

<u>CODE</u>	<u>DED</u>	<u>DATA ELEMENT TITLE (ROLE NAMED)</u>
HALTMLJB	250	HIGHWAY ALTERNATE MODEL LOAD
HALTMTJB	251	HIGHWAY ALTERNATE MODEL TYPE
HARDCIHG	151	HARDNESS CRITICAL ITEM
HAZCODHA	154	HAZARDOUS CODE
HAZMPCCA	155	HAZARDOUS MAINTENANCE PROCEDURES CODE
HDWRPREA	153	HARDWARE DEVELOPMENT PRICE
HHPLCCHA	308	INSTALLATION AND CHECKOUT ITEM PLCC
HICLNEJC	241	MILITARY LOAD CLASSIFICATION EMPTY
HICLNLJC	241	MILITARY LOAD CLASSIFICATION LOADED
HIPRMLJB	250	HIGHWAY PRIME MODEL LOAD
HIPRMTJB	251	HIGHWAY PRIME MODEL TYPE
HLCSPCXA	160	HOLDING COST PERCENTAGE
HMATLRJB	159	HELICOPTER MISSION ALTITUDE
HMDISRJB	159	HELICOPTER MISSION DISTANCE
HMPAYRJB	159	HELICOPTER MISSION PAYLOAD
HMSCOSHA	156	HAZARDOUS MATERIALS STORAGE COST
HMTDHHHG	214	INTERMEDIATE/GENERAL SUPPORT MTD
HMTIMRJB	159	HELICOPTER MISSION TIME
HMTMPRJB	159	HELICOPTER MISSION TEMPERATURE
HRCTHHHG	350	INTERMEDIATE/GENERAL SUPPORT RCT
HRDCPCCA	152	HARDNESS CRITICAL PROCEDURE CODE
HRLARTGA	161	HOURLY LABOR RATE
HRTDHHHG	355	INTERMEDIATE/GENERAL SUPPORT RTD
HWDCOSHA	157	HAZARDOUS WASTE DISPOSAL COST
HWSCODHA	158	HAZARDOUS WASTE STORAGE COST

- H -

- I -

ICCODEEK	172	SUPERCEDEURE INTERCHANGEABILITY CODE
ILSPRCEA	170	INTEGRATED LOGISTIC SUPPORT PRICE
IMTBMMBD	238	MEAN TIME BETWEEN MAINTENANCE INDUCED MEASUREMENT BASE
INAMECHA	183	ITEM NAME CODE
INCATCXA	167	INITIAL CATALOG COST
INCQTYHF	175	INTERMEDIATE CONTAINER QUANTITY
INDCODHG	162	INDENTURE CODE
INDMATHA	163	INDUSTRIAL MATERIALS ANALYSIS OF CAPACITY
INHAVAAA	164	REQUIRED INHERENT AVAILABILITY
INHAVABD	164	INHERENT AVAILABILITY
INHMAFBD	165	INHERENT MAINTENANCE FACTOR
INHMTBBB	232	MEAN TIME BETWEEN MAINTENANCE INHERENT
INHMTMBD	238	MEAN TIME BETWEEN MAINTENANCE INHERENT MEASUREMENT BASE
INMTBMBD	231	MEAN TIME BETWEEN MAINTENANCE INDUCED
INTBINXA	166	INITIAL BIN COST
INTCHCHP	172	INTERCHANGEABILITY CODE
INTCONHF	174	INTERMEDIATE CONTAINER CODE
INTRATXA	173	INTEREST RATE
INTSUBEF	071	SERD DATE OF INITIAL SUBMISSION
INVSTGXA	176	INVENTORY STORAGE SPACE
IOCAGEAH	046	INTEROPERABLE CAGE CODE
IOINTYAH	266	NUMBER TYPE
IOITNMAH	440	INTEROPERABLE ITEM TECHNICAL MANUAL NUMBER

MIL-STD-1388-2B
APPENDIX E

<u>CODE</u>	<u>DED</u>	<u>DATA ELEMENT TITLE (ROLE NAMED)</u>
IONAMEAH	182	INTEROPERABLE ITEM NAME
IONFSCAH	253	INTEROPERABLE ITEM NSN FSC
IONIINAH	253	INTEROPERABLE ITEM IDENTIFICATION NUMBER
IOREFNAH	337	INTEROPERABLE REFERENCE NUMBER
IPACDCEI	168	INPUT POWER SOURCE ALTERNATING CURRENT DIRECT CURRENT
IPFRMXEI	168	INPUT POWER SOURCE FREQUENCY RANGE MAXIMUM
IPMXRPEI	168	INPUT POWER SOURCE PERCENT MAX RIP
IPOPRGEI	168	INPUT POWER SOURCE OPERATING RANGE MINIMUM
IPPHASEI	168	INPUT POWER SOURCE PHASE
IPPOWREI	168	INPUT POWER SOURCE WATTS
IPRGMXEI	168	INPUT POWER SOURCE FREQUENCY RANGE MINIMUM
IPSOPNEI	168	SOURCE OPTION NUMBER
IPSRGMEI	168	INPUT POWER SOURCE OPERATING RANGE MAXIMUM
IRCCODEL	171	INTEGRATED LOGISTIC SUPPORT REQUIREMENT CATEGORY CODE
IRCSOCEL	365	IRCC SCOPE
ISLPTDHG	313	INTERIM SUPPORT ITEMS LIST(PTD)
ITEMNOHK	184	ITEM NUMBER
ITMCATHG	177	ITEM CATEGORY CODE
ITMDESXC	179	SYSTEM/EI ITEM DESIGNATOR CODE
ITMMGCHA	181	ITEM MANAGEMENT CODE
ITNAMEHA	182	ITEM NAME
- J -		
JJPLCCHA	308	AUTHORIZATION STOCK LIST ITEM PLCC
JOBDCDCJ	186	JOB CODE
JOBDESCJ	185	JOB
- K -		
KKPLCCHA	308	RECOMMENDED BUY LIST ITEM PLCC
- L -		
LABRATAI	189	LABOR RATE
LCNAMEXB	201	LCN NOMENCLATURE
LCNINDXB	200	LCN INDENTURE
LCNSEIHN	199	S/N PROVISIONING SYSTEM/EI LCN
LCNSEIHO	199	UOC PROVISIONING SYSTEM/EI LCN
LCNSEIXE	199	S/N SYSTEM/EI LCN
LCNSEIXF	199	UOC SYSTEM/EI LCN
LCNSTRXA	202	LCN STRUCTURE
LCNTYPBH	203	FMT LCN TYPE
LCNTYPXB	203	LCN TYPE
LCNTYPXE	203	S/N ITEM LCN TYPE
LCNTYPXF	203	UOC ITEM LCN TYPE
LENUPKHF	494	UNIT PACK LENGTH
LGCTCDEA	197	LOGISTICS CONTROL CODE
LGDCOFEA	198	LOGISTICS DECISION OFFICE
LICYSTEA	190	LIFE CYCLE STATUS
LIFSPNEA	191	LIFE SPAN
LINNUMHA	193	LINE ITEM NUMBER
LLIPTDHG	313	LONG LEAD TIME ITEMS LIST PROVISIONING TECHNICAL DOCUMENTATION

MIL-STD-1388-2B
APPENDIX E

<u>CODE</u>	<u>DED</u>	<u>DATA ELEMENT TITLE (ROLE NAMED)</u>
LLPLCCHA	308	PRESCRIBED LOAD LIST ITEM PLCC
LMTDLLHG	214	SPECIAL REPAIR ACTIVITY MTD
LOCOCOBC	425	LOGISTICS CONSIDERATION CODE
LODFACXA	195	LOADING FACTOR
LOGACCBA	196	LOGISTIC CONSIDERATIONS ACCESSIBILITY
LOGCONBA	196	LOGISTIC CONSIDERATIONS CONNECTORS
LOGCRCBA	196	LOGISTIC CONSIDERATIONS CORROSION/RUST CONTROL
LOGDSPBA	196	LOGISTIC CONSIDERATIONS DESIGN FOR SELF PROTECTION
LOGFLOBA	196	LOGISTIC CONSIDERATIONS FAULT LOCATION
LOGLABBA	196	LOGISTIC CONSIDERATIONS LABELING
LOGMAIBA	196	LOGISTIC CONSIDERATIONS MAINTENANCE BASE
LOGNARBC	426	RAM LOGISTIC CONSIDERATIONS
LOGPATBA	196	LOGISTIC CONSIDERATIONS PACKAGING AND TRANSPORTATION
LOGSAFBA	196	LOGISTIC CONSIDERATIONS SAFETY
LOGSKIBA	196	LOGISTIC CONSIDERATIONS SKILLS
LOGSTABA	196	LOGISTIC CONSIDERATIONS STANDARDIZATION
LOGTEPBA	196	LOGISTIC CONSIDERATIONS TEST POINTS
LOGTRABA	196	LOGISTIC CONSIDERATIONS TRAINING
LOTQFMHD	205	UI PRICE LOT QUANTITY FROM
LOTQFMHE	205	UM PRICE LOT QUANTITY FROM
LOTQTOHD	205	UI PRICE LOT QUANTITY TO
LOTQTOHE	205	UM PRICE LOT QUANTITY TO
LRCTLLHG	350	SPECIAL REPAIR ACTIVITY RCT
LRTDLLHG	355	SPECIAL REPAIR ACTIVITY RTD
LRUNITHG	194	LINE REPLACEABLE UNIT
LSACONHN	199	S/N PROVISIONING SYSTEM LSA CONTROL NUMBER (LCN)
LSACONHO	199	UOC PROVISIONING LSA CONTROL NUMBER (LCN)
LSACONXB	199	LSA CONTROL NUMBER (LCN)
LSACONXE	199	S/N ITEM LSA CONTROL NUMBER
LSACONXF	199	UOC ITEM LCN
LSARCDEA	204	LSA RECOMMENDATION CODE
LTYSEIXE	203	LCN S/N UOC SYSTEM/EI LCN TYPE
LTYSEIXF	203	UOC SYSTEM/EI LCN TYPE
LVLBOIHM	030	BASIS OF ISSUE LEVEL
LWHOUMEA	491	OPERATING DIMENSIONS UNIT OF MEASURE
LWHSUMEA	491	STORAGE DIMENSIONS UNIT OF MEASURE

- M -

MAIACTHG	206	MAINTENANCE ACTION CODE
MAININBH	208	MAINTENANCE INTERVAL
MAINMBBH	238	MAINTENANCE INTERVAL MEASUREMENT BASE
MAOTIMHG	221	MAXIMUM ALLOWABLE OPERATING TIME
MATERLHA	218	MATERIAL
MATNSNHA	253	NSN MATERIEL CONTROL CODE
MAXTTRAA	222	REQUIRED MAXIMUM TIME TO REPAIR
MAXTTRBD	222	MAXIMUM TIME TO REPAIR
MDCSSCGB	257	NEW OR MODIFIED SKILL SPECIALTY CODE
MDSCLCGB	386	NEW MODIFIED SKILL LEVEL CODE
MEASBSAG	238	ANNUAL OPERATING REQUIREMENT MEASUREMENT BASE
MEPRESHF	239	METHOD OF PRESERVATION CODE
MEQLINBA	243	MINIMUM EQUIPMENT LIST INDICATOR
MGCOATEA	217	MANAGING COMMAND/AGENCY

MIL-STD-1388-2B
APPENDIX E

<u>CODE</u>	<u>DED</u>	<u>DATA ELEMENT TITLE (ROLE NAMED)</u>
MGTPLNEA	216	MANAGEMENT PLAN
MILUNTJA	242	MILITARY UNIT TYPE
MINREUHG	245	MINIMUM REPLACEMENT UNIT
MISSPCBL	246	MISSION PHASE CODE
MLMTTRAC	222	MAINTENANCE LEVEL MAXIMUM TIME TO REPAIR
MLNSSUAC	265	NUMBER OF SYSTEMS SUPPORTED
MLSMHOAC	215	SCHEDULED MAN-HOUR PER OPERATING HOUR
MLUMHOAC	215	UNSCHEDULED MAN-HOUR PER OPERATING HOUR
MLPERCAC	286	MAINTENANCE LEVEL PERCENTILE
MLSAMHAC	020	MAINTENANCE LEVEL SCHEDULED ANNUAL MAN-HOURS
MLUAMHAC	020	MAINTENANCE LEVEL UNSCHEDULED ANNUAL MAN-HOURS
MLUMETAC	499	UNSCHEDULED MAINTENANCE MEAN ELAPSED TIME
MLUMMHAC	499	UNSCHEDULED MAINTENANCE MEAN MAN-HOURS
MMISDMAB	238	MEAN MISSION DURATION MEASUREMENT BASE
MMISDUAB	228	MEAN MISSION DURATION
MMPLCCHA	308	SYSTEM SUPPORT PACKAGE COMPONENT LIST PLCC
MNTPLNUM	209	SE UUT MAINTENANCE PLAN NUMBER
MOBTYPJC	249	MOBILITY TYPE
MODCHGEA	252	MODIFICATION OR CHANGE
MPCMETAD	280	MISSION PROFILE CHANGE MEAN ELAPSED TIME
MPCMMHAD	280	MISSION PROFILE CHANGE MEAN MAN-HOURS
MPOPLDBL	247	MISSION PHASE OPERATIONAL MODE
MRRMODHG	213	MAINTENANCE REPLACEMENT RATE MODIFIER
MRRONEHG	211	MAINTENANCE REPLACEMENT RATE I
MRRTWOHG	212	MAINTENANCE REPLACEMENT RATE II
MSDMETCA	224	MEASURED MEAN ELAPSE TIME
MSDMMHCA	225	MEASURED MEAN MAN-HOURS
MTBMPMBD	238	MEAN TIME BETWEEN PREVENTIVE MAINTENANCE MEASUREMENT BASE
MTBMPVBD	234	MEAN TIME BETWEEN PREVENTIVE MAINTENANCE
MTBRMBBD	238	MEAN TIME BETWEEN REMOVALS MEASUREMENT BASE
MTBRXXAG	235	REQUIRED MEAN TIME BETWEEN REMOVALS
MTBRXXBD	235	MEAN TIME BETWEEN REMOVALS
MTLEADHA	219	MATERIAL LEADTIME
MTLWGTHA	220	MATERIAL WEIGHT
MTTROPBD	236	MEAN TIME TO REPAIR OPERATIONAL
MTTRTHBD	236	MEAN TIME TO REPAIR TECHNICAL

- N -

NETEXWJA	254	NET EXPLOSIVE WEIGHT
NHAINDHH	259	NHA PLISN INDICATOR
NHAPLIHH	258	NEXT HIGHER ASSEMBLY NHA PROVISIONING LIST ITEM SEQUENCE NUMBER
NIINSNHA	253	NSN NATIONAL ITEM IDENTIFICATION NUMBER
NMFNARFD	---	NEW OR MODIFIED FACILITY NARRATIVE
NMFNCDFD	255	NEW OR MODIFIED FACILITY NARRATIVE CODE
NMSNARGC	---	NEW OR MODIFIED SKILL NARRATIVE
NMSNCDGC	256	NEW OR MODIFIED SKILL NARRATIVE CODE
NMTBMMBD	238	MEAN TIME BETWEEN MAINTENANCE NO DEFECT MEASUREMENT BASE
NOMTBMBD	233	MEAN TIME BETWEEN MAINTENANCE NO DEFECT
NOPRFFJA	260	NON-OPERABILITY FRAGILITY FACTOR
NORETSHG	261	NOT REPARABLE THIS STATION
NOSHPSAI	263	NUMBER OF SHOPS
NUMACTED	399	NUMBER OF ACTIVITIES

MIL-STD-1388-2B
APPENDIX E

<u>CODE</u>	<u>DED</u>	<u>DATA ELEMENT TITLE (ROLE NAMED)</u>
NUOPL0AA	262	NUMBER OF OPERATING LOCATIONS
- O -		
OMAMDTAA	223	OPERATIONAL MEAN ACTIVE MAINTENANCE DOWNTIME
OMLVLCAC	277	OPERATIONS AND MAINTENANCE LEVEL CODE
OMLVLCAI	277	MODELING OPERATIONS AND MAINTENANCE LEVEL CODE
OMLVLFAJ	277	OPERATIONS AND MAINTENANCE LEVEL FROM
OMLVLTAJ	277	OPERATIONS AND MAINTENANCE LEVEL TO
OMTBFMBD	238	MEAN TIME BETWEEN FAILURES OPERATIONAL MEASUREMENT BASE
OMTBMABD	230	MEAN TIME BETWEEN MAINTENANCE ACTIONS OPERATIONAL
OMTBMABD	238	MEAN TIME BETWEEN MAINTENANCE ACTIONS OPERATIONAL MEASUREMENT BASE
OMTDOOHG	214	ORGANIZATIONAL MAINTENANCE TASK DISTRIBUTION (MTD)
OPAVAIAI	273	REQUIRED OPERATIONAL AVAILABILITY
OPAVAIBE	273	OPERATIONAL AVAILABILITY
OPLNGEA	268	OPERATING LENGTH
OPMTBFBD	229	MEAN TIME BETWEEN FAILURES OPERATIONAL
OPMRBMAG	230	REQUIRED OPERATIONAL MEAN TIME BETWEEN MAINTENANCE ACTIONS
OPMTBFAG	229	REQUIRED OPERATIONAL MEAN TIME BETWEEN FAILURES
OPMTTRAA	236	REQUIRED OPERATIONAL MEAN TIME TO REPAIR
OPRHGTEA	268	OPERATING HEIGHT
OPRLIFXA	272	OPERATION LIFE
OPRMANEA	278	OPERATOR'S MANUAL
OPRQINAB	275	OPERATIONAL REQUIREMENT INDICATOR
OPRQINBE	275	RAM OPERATIONAL REQUIREMENT INDICATOR
OPRWGTEA	270	OPERATING WEIGHT
OPTPRIHF	279	OPTIONAL PROCEDURES INDICATOR
OPWIDTEA	268	OPERATING WIDTH
ORCTOOHG	350	ORGANIZATIONAL REPAIR CYCLE TIME (RCT)
ORTDOOHG	355	ORGANIZATIONAL REPLACEMENT TASK DISTRIBUTION (RTD)
OSCOSTEA	267	OPERATING AND SUPPORT COST
OSTBTIAB	403	REQUIRED STANDBY TIME
OTPACNUC	025	OTP APPORTIONED UNIT COST NONRECURRING
OTPACRUC	025	OTP APPORTIONED UNIT COST RECURRING
OTPCAGUC	046	OPERATIONAL TEST PROGRAM (OTP) CAGE CODE
OTPCTPUC	060	OTP COORDINATED TEST PLAN
OTPREFUC	337	OPERATIONAL TEST PROGRAM (OTP) REFERENCE NUMBER
OTPSFCUC	402	OTP STANDARDS FOR COMPARISON
OTPSRDUC	416	OTP SUPPORT EQUIPMENT RECOMMENDATION DATA NUMBER
OPWEEMJC	276	OPERATIONAL WEIGHT EMPTY
OPWELOJC	276	OPERATIONAL WEIGHT LOADED
OVHREPHH	281	OVERHAUL REPLACEMENT RATE

- P -

PACCATHF	282	PACKAGING CATEGORY CODE
PALCNXG	019	PHYSICAL ALC
PAMENRGE	290	PHYSICAL AND MENTAL REQUIREMENTS NARRATIVE
PARACCEC	284	SUPPORT EQUIPMENT PARAMETER ACCURACY
PARGPCEC	284	PARAMETER GROUP CODE
PARPAREC	284	SUPPORT EQUIPMENT PARAMETER
PARRVCEC	284	SUPPORT EQUIPMENT PARAMETER RANGE-VALUE CODE
PASTHREA	285	PASS THROUGH PRICE

MIL-STD-1388-2B
APPENDIX E

<u>CODE</u>	<u>DED</u>	<u>DATA ELEMENT TITLE (ROLE NAMED)</u>
PCCNUMXC	307	SYSTEM/EI PROVISIONING CONTRACT CONTROL NUMBER
PCLPTDHG	313	POST CONFERENCE LIST (PTD)
PERCENAA	286	REQUIRED PERCENTILE
PERCENBD	286	PERCENTILE
PHYSECHA	291	PHYSICAL SECURITY/PILFERAGE CODE
PINMETAD	280	PERIODIC INSP MEAN ELAPSED TIME
PINMMHAD	280	PERIODIC INSP MEAN MAN-HOURS
PIPLISHG	297	PRIOR ITEM PLISN
PKCAGEHF	046	PACKAGING DATA PREPARER CAGE
PKGCODHF	283	PACKING CODE
PLCNTYXG	203	PHYSICAL LCN TYPE
PLISNOXC	309	SYSTEM/EI PROVISIONING LIST ITEM SEQUENCE NUMBER (PLISN)
PLISNOHG	309	PROVISIONING LIST ITEM SEQUENCE NUMBER (PLISN)
PLSACNXG	199	PHYSICAL LCN
PMCSIDCA	296	PREVENTIVE MAINTENANCE CHECKS AND SERVICES INDICATOR CODE
PMDTECCA	237	PRIMARY MEANS DETECTION
PMICODHA	293	PRECIOUS METAL INDICATOR CODE
POIMETAD	280	POSTOPERATIVE INSPECTION MEAN ELAPSED TIME
POIMMHAD	280	POSTOPERATIVE INSPECTION MEAN MAN-HOURS
PPLPTDHG	313	PROVISIONING PARTS LIST (PTD)
PPSLSTHA	302	PROGRAM PARTS SELECTION LIST
PQTKUMCI	491	PROVISION QUANTITY PER TASK UNIT OF MEASURE
PQTYTKCI	319	PROVISION QUANTITY PER TASK
PRDLDTHA	299	PRODUCTION LEADTIME
PRDMETCA	224	PREDICTED MEAN ELAPSE TIME
PRDMMHCA	225	PREDICTED MEAN MAN-HOURS
PREATYEA	294	PREPARING ACTIVITY
PREMETAD	280	PREOPERATIVE INSPECTION MEAN ELAPSED TIME
PREMMHAD	280	PREOPERATIVE INSPECTION MEAN MAN-HOURS
PREOVCBA	292	PILOT REWORK OVERHAUL CANDIDATE
PROALCCI	019	TASK PROVISION ALC
PROCAGCI	046	TASK PROVISION CAGE CODE
PROELEEA	301	PROGRAM ELEMENT
PROELIHP	305	PRORATED EXHIBIT LINE ITEM NUMBER (ELIN)
PROFACXA	300	PRODUCTIVITY FACTOR
PROLCNCI	199	TASK PROVISION LCN
PROLTYCI	203	TASK PROVISION LCN TYPE
PROPSNJA	304	PROPER SHIPPING NAME
PROQTYHP	306	PRORATED QUANTITY
PROREFCI	337	TASK PROVISION REFERENCE NUMBER
PROSICHG	312	PROVISIONING SYSTEM IDENTIFIER CODE
PROUIPHD	314	UI PRICE PROVISIONING
PROUMPHE	314	UM PRICE PROVISIONING
PROVNOHL	310	PROVISIONING NOMENCLATURE
PRSMATHF	295	PRESERVATION MATERIAL CODE
PRSTDACA	287	TASK PERFORMANCE STANDARD A
PRSTDBCA	287	TASK PERFORMANCE STANDARD B
PRSTDCCA	287	TASK PERFORMANCE STANDARD C
PRSTOMXA	289	PERSONNEL TURNOVER RATE/MILITARY
PRSTOVXA	289	PERSONNEL TURNOVER RATE/CIVILIAN
PSICPOEA	303	PROGRAM SUPPORT INVENTORY CONTROL POINT
PSYSIDHG	423	PROVISIONING SYSTEM/END ITEM IDENTIFIER

MIL-STD-1388-2B
APPENDIX E

<u>CODE</u>	<u>DED</u>	<u>DATA ELEMENT TITLE (ROLE NAMED)</u>
- Q -		
QTYASYXC	316	SYSTEM/EI QUANTITY PER ASSEMBLY
QTYASYHG	316	QUANTITY PER ASSEMBLY
QTYAVAAE	324	AVAILABLE QUANTITY
QTYBOIHM	030	BASIS OF ISSUE QUANTITY
QTYFIGHK	318	QUANTITY PER FIGURE
QTYPEIXC	317	SYSTEM/END ITEM QUANTITY PER END ITEM
QTYPEIHG	317	QUANTITY PER END ITEM
QTYPROHP	322	QUANTITY PROCURED
QTYSHPHP	323	QUANTITY SHIPPED
QTYTSTEM	320	SYSTEM EQUIPMENT QUANTITY PER TEST
QTYUPKHF	321	QUANTITY PER UNIT PACK

- R -

RAILTCJB	325	RAIL TRANSPORTATION COUNTRY
RAILUSJB	326	RAIL USE
RAMCNABB	341	RAM CHARACTERISTICS NARRATIVE CODE
RAMINDBD	347	RAM INDICATOR CODE
RAMINDXB	342	RAM INDICATOR
RAMNARBB	---	RAM CHARACTERISTICS NARRATIVE
RATIOBHM	030	BASIS OF ISSUE END ITEM
RCBINCX	333	RECURRING BIN COST
RCCATCXA	334	RECURRING CATALOG COST
RCMDSABF	084	RCM DISPOSITION A
RCMDSBBF	084	RCM DISPOSITION B
RCMDSCBF	084	RCM DISPOSITION C
RCMDSDBF	084	RCM DISPOSITION D
RCMDSEBF	084	RCM DISPOSITION E
RCMDSFBF	084	RCM DISPOSITION F
RCMDSGBF	084	RCM DISPOSITION G
RCMDSHBF	084	RCM DISPOSITION H
RCMDSIBF	084	RCM DISPOSITION I
RCMDSJBF	084	RCM DISPOSITION J
RCMLOGAA	345	RELIABILITY CENTERED MAINTENANCE LOGIC UTILIZED
RCMR01BF	344	RELIABILITY CENTERED MAINTENANCE (RCM) LOGIC RESULTS 01
RCMR02BF	344	RCM LOGIC RESULTS 02
RCMR03BF	344	RCM LOGIC RESULTS 03
RCMR04BF	344	RCM LOGIC RESULTS 04
RCMR05BF	344	RCM LOGIC RESULTS 05
RCMR06BF	344	RCM LOGIC RESULTS 06
RCMR07BF	344	RCM LOGIC RESULTS 07
RCMR08BF	344	RCM LOGIC RESULTS 08
RCMR09BF	344	RCM LOGIC RESULTS 09
RCMR10BF	344	RCM LOGIC RESULTS 10
RCMR11BF	344	RCM LOGIC RESULTS 11
RCMR12BF	344	RCM LOGIC RESULTS 12
RCMR13BF	344	RCM LOGIC RESULTS 13
RCMR14BF	344	RCM LOGIC RESULTS 14
RCMR15BF	344	RCM LOGIC RESULTS 15
RCMR16BF	344	RCM LOGIC RESULTS 16
RCMR17BF	344	RCM LOGIC RESULTS 17

MIL-STD-1388-2B
APPENDIX E

<u>CODE</u>	<u>DED</u>	<u>DATA ELEMENT TITLE (ROLE NAMED)</u>
RCMR18BF	344	RCM LOGIC RESULTS 18
RCMR19BF	344	RCM LOGIC RESULTS 19
RCMR20BF	344	RCM LOGIC RESULTS 20
RCMR21BF	344	RCM LOGIC RESULTS 21
RCMR22BF	344	RCM LOGIC RESULTS 22
RCMR23BF	344	RCM LOGIC RESULTS 23
RCMR24BF	344	RCM LOGIC RESULTS 24
RCMR25BF	344	RCM LOGIC RESULTS 25
RCURCSEA	332	RECURRING
RDCODEHJ	336	REFERENCE DESIGNATION CODE
REASUPEK	327	REASON FOR SUPERCEDEURE DELETION
REFALCCA	019	REFERENCED ALTERNATE LCN CODE
REFDESHJ	335	REFERENCE DESIGNATION
REFEIACA	096	REFERENCED END ITEM ACRONYM CODE
REFLCNCA	199	REFERENCED LCN
REFNCCHA	338	REFERENCE NUMBER CATEGORY CODE
REFNUMHA	337	REFERENCE NUMBER
REFNUMHB	337	ARN ITEM REFERENCE NUMBER
REFNUMHC	337	ITEM REFERENCE NUMBER
REFNUMHN	337	S/N PROVISIONING REFERENCE NUMBER
REFNUMHO	337	UOC PROVISIONING REFERENCE NUMBER
REFNVCHA	339	REFERENCE NUMBER VARIATION CODE
REFTSKCA	427	REFERENCED TASK CODE
REFTYPCA	203	REFERENCED LCN TYPE
REMARKHI	311	PROVISIONING REMARKS
REMIPIHG	348	REMAIN IN PLACE INDICATOR
REPSURHG	351	REPAIR SURVIVAL RATE
RESTRXAX	359	RETAIL STOCKAGE CRITERIA
REVASSEA	361	REVOLVING ASSETS
REVREMEG	417	SERD REVISION REMARKS
RFDALCCB	019	REFERENCED SUBTASK ALTERNATE LCN CODE
RFDEIACB	096	REFERENCED SUBTASK END ITEM ACRONYM CODE
RFDLCNCB	199	REFERENCED SUBTASK LCN
RFDSUBCB	407	REFERENCED SUBTASK NUMBER
RFDTDCDB	427	REFERENCED SUBTASK TASK CODE
RFDTYPCB	203	REFERENCED SUBTASK LCN TYPE
RICRITBK	178	CRITICALITY NUMBER
RILPTDHG	313	REPAIRABLE ITEMS LIST (PTD)
RISSBUHG	328	RECOMMENDED INITIAL SYSTEM STOCK BUY
RMSSLIHG	329	RECOMMENDED MINIMUM SYSTEM STOCK LEVEL
RNGFRMEC	284	SUPPORT EQUIPMENT PARAMETER RANGE FROM
RNGTOCEC	284	SUPPORT EQUIPMENT PARAMETER RANGE TO
RPPCIVGB	330	RECOMMENDED CIVILIAN GRADE
RPPMILGB	330	RECOMMENDED MILITARY RANK RATE
RPWSCSAI	352	REPAIR WORK SPACE COST
RQDSTKAI	357	REQUIRED DAYS OF STOCK
RSPLISHP	353	REPLACED OR SUPERSEDING (R/S) PLISN
RTLLQTHG	331	RECOMMENDED TENDER LOAD LIST QUANTITY
- S -		
SAIPCDHA	391	SPARES ACQUISITION INTEGRATED WITH PRODUCTIONS
SAFLVLXA	363	SAFETY LEVEL

MIL-STD-1388-2B
APPENDIX E

<u>CODE</u>	<u>DED</u>	<u>DATA ELEMENT TITLE (ROLE NAMED)</u>
SAPLISHG	364	SAME AS PLISN
SBMMETCB	227	SUBTASK MEAN MINUTE ELAPSE TIME
SCAGECEM	046	SYSTEM EQUIPMENT CAGE CODE
SCPPTDHG	313	SYSTEM CONFIGURATION PROVISIONING PARTS LIST (PTD)
SCRSSCGB	369	SECURITY CLEARANCE
SDECKSJB	072	SEA DECK STOWAGE
SDSICGJC	384	SKID AREA
SECAGEEA	046	SUPPORT EQUIPMENT (SE) CAGE CODE
SECCLEBA	369	SECURITY CLEARANCE
SECITMXB	367	SECTIONALIZED ITEM TRANSPORTATION INDICATOR
SECSFCXA	421	SUPPORT OF EQUIP COST FACTOR
SECTIDJA	366	SECTIONALIZED IDENTIFICATION
SEGRCDEA	413	SUPPORT EQUIPMENT GROUPING
SEICCDEA	177	SUPPORT EQUIPMENT ITEM CATEGORY CODE
SEINARAK	---	SYSTEM/END ITEM NARRATIVE
SEINCDAK	424	SYSTEM/END ITEM NARRATIVE CODE
SEMTBFEA	229	SUPPORT EQUIPMENT MEAN TIME BETWEEN FAILURE
SEMTTREA	236	SUPPORT EQUIPMENT MEAN TIME TO REPAIR
SENARCEE	414	SUPPORT EQUIPMENT NARRATIVE CODE
SENTRAEA	371	SENSORS OR TRANSDUCERS
SEQNAREE	---	SUPPORT EQUIPMENT NARRATIVE
SEQTYAED	399	SUPPORT EQUIPMENT QUANTITY PER ACTIVITY
SERDESAA	376	SERVICE DESIGNATOR CODE
SERDESAI	376	MODELING SERVICE DESIGNATOR CODE
SERDNOEF	416	SUPPORT EQUIPMENT RECOMMENDATION DATA (SERD) NUMBER
SEREFNEA	337	SUPPORT EQUIPMENT REFERENCE NUMBER
SEREQDEA	418	SUPPORT EQUIPMENT REQUIRED
SERICCEA	356	REPORTABLE ITEM CONTROL CODE
SESHPHEA	419	SUPPORT EQUIPMENT SHIPPING HEIGHT
SESHPLEA	419	SUPPORT EQUIPMENT SHIPPING LENGTH
SESHPWEA	419	SUPPORT EQUIPMENT SHIPPING WIDTH
SESHWTEA	420	SUPPORT EQUIPMENT SHIPPING WEIGHT
SEUPGCUN	284	SUPPORT EQUIPMENT UNIT UNDER TEST PARAMETER GROUP CODE
SFPPTDHG	313	SHORT FORM PROVISIONING PARTS LIST (PTD)
SHLIFEHA	377	SHELF LIFE
SHPCONJB	380	SHIPPING CONFIGURATION
SHPDISAJ	085	SHIP DISTANCE
SHWEEMJC	381	SHIPPING WEIGHT EMPTY
SHWELDJC	381	SHIPPING WEIGHT LOADED
SIASCNEA	401	STANDARD INTERSERVICE AGENCY SERIAL CONTROL NUMBER
SKADUMJC	491	SKID AREA UNIT OF MEASURE
SKETCHEA	383	SKETCH
SKLVCDGA	386	SKILL LEVEL CODE
SKSPCDGA	387	SKILL SPECIALTY CODE
SLACTNHA	378	SHELF LIFE ACTION CODE
SLFTSTEA	370	SELF TEST CODE
SMAINCHA	392	SPECIAL MAINTENANCE ITEM CODE
SMDTECCA	237	SECONDARY MEANS DETECTION
SMMNSNHA	253	NSN SPECIAL MATERIAL IDENTIFICATION CODE/MATERIAL MANAGEMENT AGGREGATION CODE
SMRCODHG	389	SOURCE, MAINTENANCE, AND RECOVERABILITY CODE
SMRCSEEA	389	SE SOURCE, MAINTENANCE, AND RECOVERABILITY CODE
SMTBMAEA	230	SUPPORT EQUIPMENT MEAN TIME BETWEEN MAINTENANCE ACTIONS

MIL-STD-1388-2B
APPENDIX E

<u>CODE</u>	<u>DED</u>	<u>DATA ELEMENT TITLE (ROLE NAMED)</u>
SNUMSKJC	264	NUMBER OF SKIDS
SNUOCCXD	375	SERIAL NUMBER USABLE ON CODE
SPARIOEC	284	SUPPORT EQUIPMENT PARAMETER INPUT OUTPUT CODE
SPDATEHF	187	SPI NUMBER JULIAN DATE
SPEMRKHF	394	SPECIAL MARKING CODE
SPINUMHF	396	SPECIAL PACKAGING INSTRUCTION (SPI) NUMBER
SPIREVHF	397	SPI NUMBER REVISION
SPMACCHA	395	SPECIAL MATERIAL CONTENT CODE
SPMGNTTEA	393	SPECIAL MANAGEMENT
SPRCAGEK	046	SUPERCEDURE CAGE CODE
SPRFACEA	390	SPARE FACTOR
SPRREFEK	337	SUPERCEDURE REFERENCE NUMBER
SPSPEDJA	400	SPEED
SQPQTYJE	298	SECOND QUARTER PROCUREMENT QUANTITY
SQTKUMCG	491	QUANTITY PER TASK UNIT OF MEASURE
SQTYTKCG	319	QUANTITY PER TASK
SRDREVEF	360	SERD REVISION
SREFNOEM	337	SYSTEM EQUIPMENT REFERENCE NUMBER
SSCOPREA	387	SKILL SPECIALTY CODE FOR SUPPORT EQUIPMENT OPERATOR
SSCTESGB	449	TEST SCORE
SSECDECD	388	SKILL SPECIALTY EVALUATION CODE
STABYTBE	403	STANDBY TIME
STATUSEF	404	SERD STATUS
STOHGTEA	405	STORAGE HEIGHT
STOLENEA	405	STORAGE LENGTH
STOWDTEA	405	STORAGE WIDTH
STOWGTEA	406	STORAGE WEIGHT
SUBMMMCD	226	SUBTASK MEAN MAN-MINUTES
SUBNARCC	372	SEQUENTIAL SUBTASK DESCRIPTION
SUBNUMCB	407	SUBTASK NUMBER
SUBPIDCD	288	SUBTASK PERSON IDENTIFIER
SUBTIDCB	431	SUBTASK IDENTIFICATION
SUBWACCB	514	SUBTASK WORK AREA CODE
SUPCONBA	410	SUPPORT CONCEPT
SUPINDHG	422	SUPPRESSION INDICATOR
SUPITNEK	182	SUPERCEDURE ITEM NAME
SUPPKDHF	409	SUPPLEMENTAL PACKAGING DATA
SUSRNOEK	416	SUPERCEDURE SUPPORT EQUIPMENT RECOMMENDATION DATA (SERD) NUMBER
SUTALLUM	016	SE UUT ALLOWANCE
SUTCAGUM	046	SUPPORT EQUIPMENT UNIT UNDER TEST (SE UUT) CAGE CODE
SUTREFUM	337	SE UNIT UNDER TEST (UUT) REFERENCE NUMBER
SUTSTCUM	036	SE UUT CMRS STATUS
SUTYPEEK	408	SUPERCEDURE TYPE
SYSINDEXB	423	SYSTEM/END ITEM IDENTIFIER

- T -

TALCNCBH	019	TASK REQUIREMENT ALTERNATE LCN CODE
TASKCDCA	427	TASK CODE
TASKIDCA	431	TASK IDENTIFICATION
TATYPEBH	433	TASK TYPE
TCONDACA	428	TASK CONDITION A
TCONDBCA	428	TASK CONDITION B

MIL-STD-1388-2B
APPENDIX E

<u>CODE</u>	<u>DED</u>	<u>DATA ELEMENT TITLE (ROLE NAMED)</u>
TCONDCCA	428	TASK CONDITION C
TECEVLEA	435	TECHNICAL EVALUATION PRIORITY CODE
TEMTBFAG	229	REQUIRED TECHNICAL MEAN TIME BETWEEN FAILURE
TEMTBFBD	229	MEAN TIME BETWEEN FAILURES TECHNICAL
TEMTTRAA	236	REQUIRED TECHNICAL MEAN TIME TO REPAIR
TEXSEQAF	450	ADDITIONAL REQUIREMENTS TEXT SEQUENCING CODE
TEXSEQAK	450	SYSTEM END ITEM NARRATIVE TEXT SEQUENCING CODE
TEXSEQBB	450	RAM CHARACTERISTICS NARRATIVE TEXT SEQUENCING CODE
TEXSEQBC	450	RAM LOGISTICS CONSIDERATIONS TEXT SEQUENCING CODE
TEXSEQBG	450	FAILURE MODE NARRATIVE TEXT SEQUENCING CODE
TEXSEQBJ	450	FAILURE MODE INDICATOR MISSION PHASE CHARACTERISTICS NARRATIVE TEXT SEQUENCING CODE
TEXSEQCC	450	SEQUENTIAL SUBTASK DESCRIPTION TEXT SEQUENCING CODE
TEXSEQEE	450	SUPPORT EQUIPMENT NARRATIVE TEXT SEQUENCING CODE
TEXSEQEG	450	SERD REVISION TEXT SEQUENCING CODE
TEXSEQFB	450	FACILITY NARRATIVE TEXT SEQUENCING CODE
TEXSEQFC	450	BASELINE FACILITY NARRATIVE TEXT SEQUENCING CODE
TEXSEQFD	450	NEW OR MODIFIED FACILITY NARRATIVE TEXT SEQUENCING CODE
TEXSEQGC	450	NEW OR MODIFIED SKILL NARRATIVE TEXT SEQUENCING CODE
TEXSEQGE	450	PHYSICAL AND MENTAL REQUIREMENTS TEXT SEQUENCING CODE
TEXSEQHI	450	PROVISIONING TEXT SEQUENCING CODE
TEXSEQHL	450	PARTS MANUAL TEXT SEQUENCING CODE
TEXSEQJD	450	TRANSPORTED END ITEM NARRATIVE TEXT SEQUENCING CODE
TEXSEQJF	450	TRANSPORTATION NARRATIVE TEXT SEQUENCING CODE
TEXSEQUF	450	UUT EXPLANATION TEXT SEQUENCING CODE
TEXTTOCK	450	SEQUENTIAL SUBTASK DESCRIPTION TEXT SEQUENCING CODE TO
TGSCAGUN	046	TESTING SUPPORT EQUIPMENT (SE) CAGE CODE
TGSREFUN	337	TESTING SE REFERENCE NUMBER
TIMESHAJ	379	SHIP TIME
TINMETAD	280	TURNAROUND INSPECTION MEAN ELAPSED TIME
TINMMHAD	280	TURNAROUND INSPECTION MEAN MAN-HOURS
TLCNTYBH	203	TASK REQUIREMENT LCN TYPE
TL SACNBH	199	TASK REQUIREMENT LCN
TMAMDTAA	223	TECHNICAL MEAN ACTIVE MAINTENANCE DOWNTIME
TMCHGNHK	436	TM CHANGE NUMBER
TMCODEXI	437	TECHNICAL MANUAL (TM) CODE
TMDERCEA	444	TEST MEASUREMENT AND DIAGNOSTIC EQUIPMENT REGISTER CODE
TMDERIEA	445	TEST MEASUREMENT AND DIAGNOSTIC EQUIPMENT REGISTER INDEX NUMBER
TMFGCDHK	438	TM FUNCTIONAL GROUP CODE
TMFGCDXB	438	TECHNICAL MANUAL FUNCTIONAL GROUP CODE
TMINDCHK	439	TM INDENTURE CODE
TMNUMBXI	440	TECHNICAL MANUAL NUMBER
TMRQCDEA	441	TECHNICAL MANUAL REQUIRED CODE(S)
TMTBFMBD	238	MEAN TIME BETWEEN FAILURES TECHNICAL MEASUREMENT BASE
TMTBMAAG	230	REQUIRED TECHNICAL MEAN TIME BETWEEN MAINTENANCE ACTIONS
TMTBMABD	230	MEAN TIME BETWEEN MAINTENANCE ACTIONS TECHNICAL
TMTBMMBD	238	MEAN TIME BETWEEN MAINTENANCE ACTIONS TECHNICAL MEASUREMENT BASE
TOCCODXC	481	SYSTEM/EI TYPE OF CHANGE CODE
TOCCODHG	481	TYPE OF CHANGE CODE
TOSNUMHN	373	S/N PROVISIONING SERIAL NUMBER TO
TOSNUMXD	373	SERIAL NUMBER TO
TOSNUMXE	373	S/N SERIAL NUMBER TO
TOSRNOHQ	374	SERIAL NUMBER EFFECTIVITY TO

MIL-STD-1388-2B
APPENDIX E

<u>CODE</u>	<u>DED</u>	<u>DATA ELEMENT TITLE (ROLE NAMED)</u>
TOSYSUAA	454	TOTAL SYSTEMS SUPPORTED
TOTICHHP	452	TOTAL ITEM CHANGES
TOTQTYHG	453	TOTAL QUANTITY RECOMMENDED
TPAUCNUE	025	TPI APPORTIONED UNIT COST NONRECURRING
TPAUCRUE	025	TPI APPORTIONED UNIT COST RECURRING
TPICAGUE	046	TEST PROGRAM INSTRUCTION (TPI) CAGE CODE
TPIREFUE	337	TPI REFERENCE NUMBER
TPISRDU	416	TPI SUPPORT EQUIPMENT RECOMMENDATION DATA NUMBER
TPISTSUE	370	TPI SELF TEST
TPITDPUE	434	TPI TECHNICAL DATA PACKAGE
TPSAUMJC	491	TRACKED PAD SHOE AREA UNIT OF MEASURE
TQPQTYJE	298	THIRD QUARTER PROCUREMENT QUANTITY
TRAFYRJE	145	TRANSPORT FISCAL YEAR
TRANARJF	---	TRANSPORTATION NARRATIVE
TRANCDJF	470	TRANSPORTATION NARRATIVE CODE
TRANCNJB	465	TRANSPORTATION CHARACTERISTIC NUMBER
TRASEIXC	467	TRANSPORTATION END ITEM INDICATOR
TRCHMTJB	464	TRANSPORTATION CHARACTERISTIC MODE TYPE
TRCHRDJA	071	REVISION DATE
TRCHTHJA	451	THEATER OF OPERATION
TRCONMJC	473	TRANSPORTED CONFIGURATION NUMBER
TRDNUMUM	448	SE UUT TEST REQUIREMENTS DOCUMENT NUMBER
TREINCJD	474	TRANSPORTED END ITEM NARRATIVE CODE
TRGRPRJC	456	TRACKED GROUND CONTACT PRESSURE
TRITDRJB	469	TRANSPORTATION ITEM DESIGNATOR
TRNCOSGA	460	TRAINING COST
TRNCSTXA	466	TRANSPORTATION COST
TRNINDJA	468	TRANSPORTATION INDICATOR
TRNLOCCA	461	TRAINING LOCATION RATIONALE CODE
TRNRATCA	462	TRAINING RATIONALE
TRNRECCA	463	TRAINING RECOMMENDATION TYPE
TRNRQCCA	358	TRAINING EQUIPMENT REQUIREMENT CODE
TRNUPTJC	458	TRACKED PADS TOUCHING
TRPSARJC	457	TRACKED PAD SHOE AREA
TRRWWTJC	459	TRACKED ROAD WHEEL WEIGHT
TSCAGECG	046	TASK SUPPORT CAGE CODE
TSEREQCA	358	TOOL/SUPPORT EQUIPMENT REQUIREMENT CODE
TSFROMCK	450	SEQUENTIAL SUBTASK DESCRIPTION TEXT SEQUENCING CODE FROM
TSKALCCI	019	TASK ALTERNATE LCN CODE (ALC)
TSKCRCCA	429	TASK CRITICALITY CODE
TSKFRQCA	430	TASK FREQUENCY
TSKLCNCI	199	TASK LSA CONTROL NUMBER (LCN)
TSKLTICI	203	TASK LCN TYPE
TSKREMCE	432	TASK REMARK
TSKRRCCE	349	TASK REMARK REFERENCE CODE
TSKTCDCI	427	TASK PROVISION TASK CODE
TSREFNCG	337	TASK SUPPORT REFERENCE NUMBER
TSSCODXA	484	TYPE OF SUPPLY SYSTEM CODE
TSTPTSEA	446	TEST POINTS
TSTLNGEA	443	TEST LANGUAGE
TTASKCBH	427	TASK CODE
TTLPTDHG	313	TOOL AND TEST EQUIPMENT LIST (PTD)
TUIPRCHD	485	UI PRICE TYPE OF PRICE CODE

MIL-STD-1388-2B
APPENDIX E

<u>CODE</u>	<u>DED</u>	<u>DATA ELEMENT TITLE (ROLE NAMED)</u>
TUMPRCHE	485	UM PRICE TYPE OF PRICE CODE
TWALFIJC	029	FRONT INSIDE AXLE LENGTH
TWALFOJC	029	FRONT OUTSIDE AXLE LENGTH
TWALRIJC	029	REAR INSIDE AXLE LENGTH
TWALROJC	029	REAR OUTSIDE AXLE LENGTH
TWSPEDJA	455	TOWING SPEED
TYPACTED	399	TYPE OF ACTIVITY
TYPCLSEA	479	TYPE CLASSIFICATION
TYPEEQEA	480	TYPE EQUIPMENT CODE

- U -

UCLEVLHF	487	UNIT CONTAINER LEVEL
UHEIGHHA	496	UNIT SIZE HEIGHT
UICONVHA	489	UNIT OF ISSUE CONVERSION FACTOR
UIPRICHD	490	UNIT OF ISSUE (UI) PRICE
ULENGTHA	496	UNIT SIZE LENGTH
UMNTPLUA	209	UUT MAINTENANCE PLAN NUMBER
UMPRICHE	492	UNIT OF MEASURE (UM) PRICE
UMSEWTEA	491	SE SHIPPING WEIGHT UNIT OF MEASURE
UMSHIPEA	491	SE SHIPPING DIMENSIONS UNIT OF MEASURE
UNICONHF	486	UNIT CONTAINER CODE
UNITISHA	488	UNIT OF ISSUE
UNITMSHA	491	UNIT OF MEASURE
UNPKCUHF	493	UNIT PACK CUBE
UNPKWTHF	495	UNIT PACK WEIGHT
UOCSEIXC	501	USABLE ON CODE
USESEREA	376	USING SERVICE DESIGNATOR CODE
UTALLOUA	016	UUT ALLOWANCE
UTCMRSUB	035	UUT CALIBRATION MEASUREMENT REQUIREMENTS SUMMARY RECOMMENDED CODE
UTEXPLUF	498	UUT EXPLANATION
UTLCNTUA	203	UUT LCN TYPE
UTPAACUN	284	SE UUT PARAMETER ACCURACY
UTPACMUN	034	SE UUT CALIBRATION MEASUREMENT REQUIREMENTS SUMMARY PARAMETER CODE
UTPAIOUN	284	SE UUT PARAMETER INPUT/OUTPUT CODE
UTPAPAUN	284	SE UUT PARAMETER
UTPARVUN	284	SE UUT PARAMETER RANGE/VALUE CODE
UTPATAUN	442	SE UUT PARAMETER TEST ACCURACY RATIO (TAR) ACTUAL
UTPATDUN	442	SE UUT PARAMETER TAR DESIRED
UTPRRTUN	284	SE UUT PARAMETER RANGE TO
UTRATIAE	503	UTILIZATION RATIO
UTRGFRUN	284	UUT PARAMETER RANGE FROM
UTSTCDUB	036	UUT CALIBRATION MEASUREMENT REQUIREMENT SUMMARY STATUS
UTTRDNUA	448	UUT TEST REQUIREMENTS DOCUMENT NUMBER
UTWPRFUA	515	UUT WORK PACKAGE REFERENCE
UUTALCUA	019	UUT ALTERNATE LCN CODE
UUTFA1UH	143	UUT FIRU AMBIGUITY GROUP 1
UUTFA2UH	143	UUT FIRU AMBIGUITY GROUP 2
UUTFP1UH	143	UUT FIRU PERCENT FAILURE 1
UUTFP2UH	143	UUT FIRU PERCENT FAILURE 2
UUTFTDUH	447	UUT FIRU TEST REQUIREMENTS DOCUMENT INDICATOR
UUTLCNUA	199	UUT LSA CONTROL NUMBER (LCN)
UUTPACUG	284	UUT PARAMETER ACCURACY

MIL-STD-1388-2B
APPENDIX E

<u>CODE</u>	<u>DED</u>	<u>DATA ELEMENT TITLE (ROLE NAMED)</u>
UUTPARUG	284	UUT PARAMETER
UUTPGCUG	284	UUT PARAMETER GROUP CODE
UUTPIOUG	284	UUT PARAMETER INPUT/OUTPUT CODE
UUTPPCUG	034	UUT CALIBRATION MEASUREMENT REQUIREMENT SUMMARY PARAMETER CODE
UUTPRFUG	284	UUT PARAMETER RANGE FROM
UUTPRUG	284	UUT PARAMETER RANGE TO
UUTPRVUG	284	UUT PARAMETER RANGE/VALUE CODE
UUTPSOUG	284	UUT PARAMETER OPERATIONAL SPECIFICATION CODE
UUTPTAUG	442	UUT PARAMETER TEST ACCURACY RATIO (TAR) ACTUAL
UUTPTDUG	442	UUT PARAMETER TAR DESIRED
UWEIGHHA	497	UNIT WEIGHT
UWIDTHHA	496	UNIT SIZE WIDTH

- W -

WEOLIBA	505	WEAROUT LIFE
WGTOUMEA	491	OPERATING WEIGHT UNIT OF MEASURE
WGTSUMEA	491	STORAGE WEIGHT UNIT OF MEASURE
WHINPRJC	507	WHEELED INFLATION PRESSURE
WHNUPLJC	508	WHEELED NUMBER OF PLIES
WHNUTIJC	509	WHEELED NUMBER OF TIRES
WHTIFTJC	512	WHEELED TIRE SIZE
WHTLDRJC	510	WHEELED TIRE LOAD RATING
WHTRLOJD	---	TRANSPORTED END ITEM NARRATIVE
WHWERAJC	513	WHEELED WEIGHT RATINGS
WIDUPKHF	494	UNIT PACK WIDTH
WKPKRFUM	515	SE UUT WORK PACKAGE REFERENCE
WOLIMBBA	238	WEAROUT LIFE MEASUREMENT BASE
WPADDRAF	009	ADDITIONAL REQUIREMENTS
WRAPMTHF	517	WRAPPING MATERIAL
WRKUCDHG	516	WORK UNIT CODE
WSOPLVXA	271	OPERATION LEVEL
WSTYAQXA	478	TYPE ACQUISITION

- Y -

YRFLDGEA	518	YEAR OF FIELDING
----------	-----	------------------

THIS PAGE INTENTIONALLY LEFT BLANK

APPENDIX E - SECTION 3

DATA ELEMENT DEFINITIONS

001 ACHIEVED AVAILABILITY (A_a) 8 N R 6

The probability that, when used under stated conditions in an ideal support environment, a system will operate satisfactorily at any time. This differs from Inherent Availability only in its inclusion of consideration for preventive action. A_a excludes supply downtime and administrative downtime. The measurement bases for MTBM and M must be consistent when calculating A_a.

A_a may be expressed by the following formula:

$$A_a = \frac{MTBM}{MTBM + M}$$

$$\text{where } MTBM = \left(\frac{1}{MTBF} + \frac{1}{MTBM-ND} + \frac{1}{MTBPM} \right)^{-1}$$

$$= N \frac{\sum_{i=1}^N (ET_i) (TF_i)}{\sum_{i=1}^N TF_i}$$

M = Mean active maintenance downtime (where corrective and preventive actions are considered)

ET_i = Elapsed time for task i

TF_i = Task frequency for task i

N = Total number of tasks performed

Note: The measurement bases for MTBF, MTBM-ND, and MTBPM must be consistent when calculating the MTBM parameter.

REQUIRED ACHIEVED AVAILABILITY. An A_a representing the requirement/specification A_a.

002 ACQUISITION DECISION OFFICE 15 X L -

Identifies the activity name and code or office symbol responsible for technical and acquisition management decisions.

003 ACQUISITION METHOD CODE (AMC) 1 N F -

A code assigned by Department of Defense (DOD) activities to describe the results of screening reviews of parts, defining either a single source or

MIL-STD-1388-2B
APPENDIX E

competitive procurement direction for the item. For codes and explanations refer to DOD 4100.38-M.

004 ACQUISITION METHOD SUFFIX CODE 1 X F -
(AMSC)

A code assigned by DOD activities to provide a further description of the acquisition method code by adding information concerning the status of a part in areas such as engineering, manufacturing, and technical data. For codes and explanations, refer to DOD 4100.38-M.

005 ADAPTER/INTERCONNECTION DEVICE 1 A F -
REQUIRED

A single position code indicating whether an adapter interconnection device is required to provide mechanical and electrical connection between the Automatic Test Equipment (ATE)/Test, Measurement, and Diagnostic Equipment and a unit under test.

Required Y
Not Required N

006 ADDITIONAL REFERENCE NUMBER (ARN) 32 X L -

A drawing or interchangeable reference number related to the reference number of the item under analysis. Only those ARNs that are known and available as a result of the contractor's design and production experience should be provided. This requirement is not intended to burden the contractor with the additional work load of searching for ARNs. When more than one manufacturer's reference number identifies a single design item, the additional reference number(s) which have been validated by the contractor as completely interchangeable for the specific application and whose use will not invalidate the end item warranty shall be furnished.

007 ADDITIONAL SKILL REQUIREMENT: SKILL 65 X - -
REQUIRING A NEW OR REVISED SKILL CODE

A narrative description identifying the new skills that are required in order to operate/maintain the equipment.

008 ADDITIONAL SKILLS AND SPECIAL 65 X - -
TRAINING REQUIREMENTS

A narrative description identifying the new skills required to operate/maintain the equipment, and the additional training required for operator, maintenance, and instructor personnel. Includes the estimated lengths of courses, recommended site, justification for training, and prerequisite requirements for students.

009 ADDITIONAL SPECIFICATIONS/REQUIREMENTS 65 X - -

A narrative description of any specifications or requirements (related to the anticipated operation of the system, or the environment in which the

MIL-STD-1388-2B
APPENDIX E

system will be operated and maintained) that cannot be documented under the detailed specification/requirements data.

010 ADDITIONAL SUPPORTABILITY CONSIDERATIONS 65 X - -

A narrative description of LSA modeling considerations which cannot be documented in the discrete supportability data elements. It may include such information as acceptable models, program or model specific information, etc.

011 ADDITIONAL SUPPORTABILITY PARAMETERS 65 X - -

A narrative including a listing and description of specific data elements for which discrete fields are not provided. The documentation should also include the data element title, associated value to be recorded, associated units, and a description as necessary to define the scope and purpose of the data element and its use.

012 ADDITIONAL TRAINING REQUIREMENTS 65 X - -

A narrative description identifying the additional training required for operator, maintenance, and instructor personnel. Includes the estimated length of courses, recommended site, justification for training and prerequisite requirements for students.

013 ADMINISTRATIVE AND LOGISTIC DELAY TIME (ALDT) 3 N R -

The total time in days the system/equipment is inoperable due to delays in maintenance that are attributable to administration and logistics.

REQUIRED ALDT. An ALDT representing the requirement/specification ALDT.

014 ADMINISTRATIVE LEAD TIME 2 N R -

The administrative time (in days) required to prepare, advertise and award a contract for wholesale supply reorder actions.

015 ALLOCATION DATA 60 X - -

The support equipment allocation information consisting of seven subfields:

a. Allowance (DED 016) 10 X L -

b. Station Identification Code 5 X L -

An alpha-numeric code to identify a specific automatic test equipment station or location with the associated allowance list. The code is provided by the requiring authority.

c. Maintenance Level Function 2 X L -

MIL-STD-1388-2B
APPENDIX E

A two-character code specifying the level of maintenance at which a particular task employing the support equipment will be accomplished. Codes are as follows:

NAVY

Organizational level	O
Organizational and intermediate land and vessel	OI
Intermediate	I
Intermediate weapon station	IW
Depot level	D
Three degrees of intermediate propulsion system maintenance	I1, I2 or I3
Transient/bingo sites	T

ARMY, AIR FORCE, AND FEDERAL AVIATION ADMINISTRATION

Organizational level	O
Intermediate level, on equipment	F
Intermediate level, off equipment	H
Depot level	D

d. Land Vessel Code 1 A F -

A code (primarily used by the Navy) to restrict and control the selection of support equipment end items required for different environmental conditions. Codes are as follows:

Land	L
Vessel	V
Both	B

e. Allowance Range 30 N AS -

A 10 block spread format (Allowance Range 1-10 used to record the allowance for the end item, ATE item, or depot overhaul requirements). The Allowance Code (DED 016) will distinguish whether the allowance ranges are for end items, ATE items, or depot overhaul requirements. These 10 blocks may be labeled 1-4 through 251-450 to describe the number of end articles to be supported by the quantity of support equipment end items entered in the three (3) position subfield. Block headings are: 1-4, 5-8, 9-12, 13-16, 17-24, 25-32, 33-64, 65-125, 126-250 and 251-450, respectively. For example: For SE end items, the quantity of end items required to support a range of 5 to 8 end articles is identified in the block labeled 5-8.

(1) For ATE items, the 10 blocks are associated with 1, 2, 3...10 to describe the number of ATE items to be supported by the quantity of support equipment items entered in the three position subfield.

(2) For depot overhaul requirements/entries, associate the first three blocks with workload rates of 20, 50, 100 end articles per month to be supported by the quantity of support equipment items entered in the three-position subfield.

MIL-STD-1388-2B
APPENDIX E

f. Extended Range 3 X R -

A field designating the quantity of SE items required to support quantities of end articles exceeding 450.

g. Designation Description 9 X F -

A nine-position code that identifies the method of allowancing items. The codes include the following:

Inventory Record	INVRECORD
No longer applies for this list code	NOTAPPLIC
Per crash crew	PERCRACRW

Where 99 represents quantity of end articles and XXXX represents specific entities, e.g., PER02ACFT indicates an allowance based on supporting two aircraft. Entries for XXXX include:

Aircraft	ACFT
Missile	MISL
Engine	ENGN
Metrology Labs	LABS
Targets	TRGT

016 ALLOWANCE 10 X L -

Allowance identifies the Army Table of Organization and Equipment (TO&E), the Navy List Code, or the Air Force Table of Authorization that will be the allowance source document for the article requiring support.

017 ALLOWANCE ITEM CODE (AIC) 2 X F -

Consists of two subfields: Allowance Type and Allowance Code.

a. Allowance Type 1 A F -

A code which indicates the type of item.

Basic issue item category code (Army)	A
Allowance note code (Navy)	B
Technical override (TOR) code (Navy)	C
Allowance factor code (Air Force)	D
Stockage list category (Marine Corps)	E

b. Allowance Code 1 X F -

A code which further defines and categorizes the allowance type.

(1) When an Allowance Type code of "A" is specified, one of the following codes must be used for Allowance Code.

MIL-STD-1388-2B
APPENDIX E

Basic issue item	A
Component of end item	C
Expendable/durable supplies and materials	D
Additional authorization list items (modified table of organization and equipment)	E
Additional authorization list items (other)	F

(2) When an Allowance Type code of "B" is specified, one of the following codes must be used for Allowance Code.

Indicates an operating space item regardless of vessel type. The Stock Number Sequence List (SNSL) reflects a quantity for each application. 1

REFER TO YOUR ALLOWANCE PARTS LIST (APL) to determine if the Repair Part is required (since exceptions are annotated on the APL when the repair part may not be required) or where a choice must be made to select the correct repair part. 2

Represents the superseding repair part due to redesign or material change. The superseded stock number appears as alternate information in part III, section D, of the Coordinated Shipboard/Allowance List (COSAL). The superseded item, presently on board, can be used without adverse effect to the component, if the superseded item is presently on board, utilize the stock under the superseded number before ordering deficiencies. 3

An item with an NSN for bulk material that is to be used in the fabrication of the item listed in the parts list. Requisition as required. 4

Denotes CLASSIFIED PART and should be requisitioned and stored IAW current security regulations. 5

An RSS (Ready Service Spare) which will appear in the COSAL section III CR of the SNSL. This item may also appear in section IIIA of the SNSL as a storeroom item for this APL application if anticipated usage warrants backup support. 6

Denotes an item that is to be requisitioned and stowed IAW confidential instructions. This note applies to operating frequency control crystals allowance. 7

Indicates an accessory component/components applicable to a parent equipment. 8

Item(s)/part(s) for which only the Commanding Officer or his designated representative is specifically responsible for the physical custody and safekeeping thereof. 9

Represents an item that has been coded to deviate from the NORMAL MAINTENANCE POLICY expressed by the Lead APL. A

MIL-STD-1388-2B
APPENDIX E

The responsible hardware command authorizing this deviation will be annotated in the characteristic portion of the APLs.

Indicates that the ORDNANCE alternation has been performed and repair parts are not required. C

Applicable to S/O/S (SHIPALT/ORDALT/SPALT) items, indicates the quantity by which the effected APL population of the item has been decreased after accomplishment of the S/O/S. D

Indicates that a Technical Override (TOR) or Planned Maintenance Requirement (PMR) is included in the allowed quantity. E

Indicates that note codes 3 and E, above, apply to the item. F

Indicates that note codes 2 and E, above, apply to the item. G

Represents an item listed on Allowance Equipage Lists (AELs) to provide technical information only and is not an authorized allowance. H

Indicates that Note Code 1 or X and Note Code 2 both apply to the item. J

Represents a module required to execute an approved maintenance plan which calls for identifying the fault or failed module through progressive/selective module substitution. Maintenance Assistance Modules (MAM) will be included as an Operating Space Item (OSI) in the COSAL, section III CF of the Stock Number Sequence List (SNSL). The item may also appear in section IIIA of the SNSL as a storeroom item for this APL application if anticipated usage warrants backup support. N

Represents the preferred item in a situation where two or more items are interchangeable. The alternate nonpreferred item(s), if presently on board, may be utilized to satisfy the allowance requirement; however, when a shortage exists the preferred item of stock should be requisitioned. The alternate item of stock will appear in the Preferred-to Alternate Substitute Cross-Reference List. S

Select at test. All NSNs required for the selection are listed for each circuit symbol. Item needed must be selected from among the listed NSNs based on equipment operating requirements. A suffix has been assigned to the circuit symbol for identification. T

Variable. See the characteristics portion of APL. V

APL will state: NSN...has been cancelled -- it cannot be procured. When part fails, replace with the next higher assembly. W

MIL-STD-1388-2B
APPENDIX E

Indicates an operating space item. The SNSL quantity is established by the highest single application quantity in all of the items X code applications. X

On Board Repair Part (OBRP) Kits. OBRP quantities are included in the APPL (Application) column of section B and the QTY in one equip/comp columns of section A. These kits should be retained as OBRP even if not listed in the COSAL SNSL/Integrated Stock List (ISL). Z

(3) When an Allowance Type code of "C" is specified, one of the following codes must be used for Allowance Code.

Operational Availability Override Requirement. Indicates that the Allowance Override quantity (C007A) finite quantities determine the allowance quantity for the Operational Availability computational math model. For a given item, a comparison between the single highest "A" quantity, other overrides, the sum of all PMR, and the computed demand-based quantity, is made and the highest single quantity is selected as the authorized allowance. A

Critical Candidate. Identifies items to be stored as higher supply echelons (see Note 1 below). C

Disapproved Technical Override. TOR reviewed and disapproved by the cognizant Hardware Systems Command for .25 Fleet Logistic Support Improvement Program (FLSIP) computations, under .15 computation item allowance determined by the C007A finite quantities (see Note 2 below). D

Early Supply Support (ESS). Indicates that the finite quantity in C007A is used in place of the quantity per allocation for allowance computation. E

Approved TOR Mission Override. TOR accepted to support primary mission. The C007A finite quantity determines the allowance for a particular item. M

Planned Maintenance Requirement (PMR). Indicates that the C007A finite quantities for an item are additive across all applications, and the summarized PMR quantity determines the authorized allowance when compared with other overrides and the computed demand-based allowance. P

Requisition as Required. Indicates that "AR" is printed in the quantity field for an item. Programs disregard quantities in C007A. "R" overrides all other populations for an item. R

MIL-STD-1388-2B
APPENDIX E

Safety Equipment. Specified C007A quantity is justified allowance to ensure safety and preserve life.	S
Technical Override. Indicates that the highest finite C007A quantity for a given item is compared with the summarized PMR quantity, other override quantities, and the demand-based computed quantity, the highest of these quantities becomes the authorized allowance. Applies to .15 FLSIP only.	T
Disapproved TOR. Justification reserved for future use.	V
Operational Availability Underride. Indicates that the item population for this application is not used to determine allowance quantities. No finite quantity is loaded in C007A (used to exclude items from the Operational Availability model).	Y
Zero Override. Indicates that the item population for this application is not used to determine allowance quantities. No finite quantity is loaded in C007A. Used to exclude items from FLSIP model.	Z

NOTE:

1. An informational code designed to assist in the future selection of items to be stocked at higher echelons. Instructions for the use of this code will be provided by the requiring authority. C-coded items will be processed in the same manner as D-coded items.

2. D-coded items will still be considered as valid candidates for on-board stocking and can be included on allowances if other support criteria is met.

(4) When an Allowance Type code of "D" is specified, the requiring authority will specify the code to be used for Allowance Code.

(5) When an Allowance Type code of "E" is specified, one of the following codes must be used for Allowance Code:

Principal end item	A
Using unit responsible item	C
Supply system responsible item	D
Collateral Equipment	E

018 ALLOWANCE ITEM QUANTITY 3 N R -

A quantity which is defined by the Allowance Item Code.

019 ALTERNATE LOGISTIC SUPPORT ANALYSIS 2 N L -
CONTROL NUMBER CODE (ALC)

MIL-STD-1388-2B
APPENDIX E

A code used to allow documentation of multiple models of a system/equipment, or alternate design considerations of an item, using the same Logistic Support Analysis Control Number (LCN) breakdown. See appendix C for detailed guidance on the ALC, its usage, and relationship to LCN and Usable on Codes (UOC).

Note: ALC of zero zero "00" will always be used as the basic system. There are no blanks allowed. ALC's will be assigned from 01 to 99 in ascending order.

AOR ALC. An ALC against which the AORs are documented.

FMT ALTERNATE LCN CODE. An ALC representing the failure mode which has either a corrective or preventive task documented against it.

FUNCTIONAL ALTERNATE LCN CODE. An ALC representing the functional system/equipment breakdown.

PHYSICAL ALTERNATE LCN CODE. An ALC representing the hardware breakdown of the system/equipment.

REFERENCED ALTERNATE LCN CODE. An ALC used to identify the referenced task information.

REFERENCED SUBTASK ALTERNATE LCN CODE. An ALC used to identify the referenced subtask information.

S/N ITEM ALTERNATE LCN CODE. An ALC representing the item under analysis having a serial number (S/N) relationship.

S/N PROVISIONING ALTERNATE LCN CODE. An ALC representing the provisioned item under analysis having a S/N relationship.

S/N PROVISIONING SYSTEM/EI ALC. An ALC representing the provisioned system/end item having a S/N relationship.

S/N SYSTEM/END ITEM ALC. An ALC representing the system/end item having a S/N relationship.

TASK ALTERNATE LCN CODE. An ALC of the item under task analysis.

TASK PROVISION ALC. An ALC of the item which is to be provisioned based on the task analysis of the Task LCN.

TASK REQUIREMENT ALTERNATE LCN CODE. An ALC of the item undergoing task analysis.

UOC ITEM ALTERNATE LCN CODE. An ALC representing the item under analysis having a Usable On Code (UOC) relationship.

UOC PROVISIONING ALTERNATE LCN CODE. An ALC representing the provisioned item under analysis having a UOC relationship.

MIL-STD-1388-2B
APPENDIX E

UOC PROVISIONING SYSTEM/EI ALC. An ALC representing the provisioned system/end item having a UOC relationship.

UOC SYSTEM/EI ALC. An ALC representing the system/end item having a UOC relationship.

UUT ALTERNATE LCN CODE. An ALC of the Unit Under Test (UUT).

020 ANNUAL MAN-HOURS 12 N - AS

The sum of the working time of each SSC required for the performance of a unit of work accumulated for a period of a year. This field is divided into two subfields of Scheduled and Unscheduled.

a. Scheduled 6 N R 1

The number of annual man-hours expended for preventive maintenance.

MAINTENANCE LEVEL SCHEDULED ANNUAL MAN-HOURS. The scheduled annual manhours for a given maintenance level.

b. Unscheduled 6 N R 1

The number of annual man-hours expended for corrective maintenance.

MAINTENANCE LEVEL UNSCHEDULED ANNUAL MAN-HOURS. The unscheduled annual man-hours for a given maintenance level.

021 ANNUAL NUMBER OF MISSIONS 6 N R -

The estimated or specified mean number of missions an item will be expected to accomplish in one year.

022 ANNUAL OPERATING DAYS 3 N R -

The mean number of days per year that a mission demand will be placed on an item.

023 ANNUAL OPERATING REQUIREMENTS (AOR) 6 N R -

The estimated or required yearly rate of usage of an item.

024 ANNUAL OPERATING TIME 4 N R -

The total hours that the item under analysis is expected to be operated during a calendar year.

025 APPORTIONED UNIT COST 16 N - -

The amount in U.S. dollars given, paid, charged, or engaged to be paid or given for items or service on a nonrecurring (one time occurrence) and recurring (repeating occurrence) cost basis, that is assigned the material or equipment required to test a particular UUT.

MIL-STD-1388-2B
APPENDIX E

a. Nonrecurring 8 N R -

AID APPORTIONED UNIT COST NONRECURRING. The nonrecurring cost of the adapter interconnector device.

OTP APPORTIONED UNIT COST NONRECURRING. The nonrecurring cost of the operational test program.

TPI APPORTIONED UNIT COST NONRECURRING. The nonrecurring cost of the test program instruction.

b. Recurring 8 N R -

AID APPORTIONED UNIT COST RECURRING. The recurring cost of the adapter interconnector device.

OTP APPORTIONED UNIT COST RECURRING. The recurring cost of the operational test program.

TPI APPORTIONED UNIT COST RECURRING. The recurring cost of the test program instruction.

026 ARMED SERVICES VOCATIONAL APTITUDE 24 X - AS
BATTERY (ASVAB) SCORE

Data documenting the ASVAB scores for the skill specialty under analysis. This field is composed of the following subfields.

a. Armed Forces Qualification Test (AFQT) 10 N - AS

This is a measure of general trainability compiled from the ASVAB test.

This field is composed of five subfields:

- (1) ASVAB AFQT Score 2 N F -
- (2) ASVAB AFQT Expected Range Low 2 N F -
- (3) ASVAB AFQT Expected Range High 2 N F -
- (4) ASVAB AFQT Lowest Percent Low 2 N F -
- (5) ASVAB AFQT Lowest Percent High 2 N F -

b. Armed Service Aptitude Battery (ASVAB) 14 N - AS

This is a battery of tests given to identify the aptitudes of the personnel being tested. These tests are used in performing trade-offs of personnel aptitude and training in the prediction of performance of military systems.

This field is composed of five subfields:

- (1) ASVAB Aptitude Element 2 A F -

MIL-STD-1388-2B
APPENDIX E

	(2) ASVAB Element Expected Range Low	3 N F -
	(3) ASVAB Element Expected Range High	3 N F
	(4) ASVAB Element Lowest Percent Low	3 N F
	(5) ASVAB Element Lowest Percent High	3 N F -
027	AUTOMATIC DATA PROCESSING EQUIPMENT CODE	1 N F -
	A code which identifies an item of automatic data processing equipment (ADPE) or containing ADPE, regardless of Federal Supply Classification (FSC) to provide visibility for compliance with unique manager requirement established for ADPE by Public Law 89-306. Applicable codes are contained in DOD 4100.38-M.	
028	AVAILABLE MAN-HOURS	6 N R -
	The total annual number of man-hours for which a SSC is available to perform assigned tasks.	
029	AXLE LENGTH	16 N - AS
	The inside and outside track width of both the front and rear axles measured in tenths of inches.	
	a. Front Inside (FI).	4 N R 1
	The distance from the inside of the innermost front tire to the inside of the opposite front innermost tire.	
	b. Front Outside (FO).	4 N R 1
	The distance from the outside of the outermost front tire to the outside of the opposite front outermost tire.	
	c. Rear Inside (RI).	4 N R 1
	The distance from the inside of the innermost rear tire to the inside of the opposite rear innermost tire.	
	d. Rear Outside (RO).	4 N R 1
	The distance from the outside of the outermost rear tire to the outside of the opposite rear outermost tire.	
030	BASIS OF ISSUE (BOI)	15 X - -
	This field is composed of the following four subfields:	
	a. Quantity Authorized (QTY-AUTH)	5 N R -

MIL-STD-1388-2B
APPENDIX E

The quantity of an item (special tool), authorized for the end item density spread or for the unit level specified.

b. End Item 8 X L -
The density spread of the end items.

c. Level 1 A F -

A code which indicates the unit level authorized for the QTY-AUTH.

QTY-AUTH per lettered company	A
QTY-AUTH per battalion (BN) headquarters (HQ) when BN has a service (SVC) company	B
QTY-AUTH per HQ of units above BN level	C
QTY-AUTH by BN and brigade (BDG) type HQ (except when BN or BDG has SVC company)	D
QTY-AUTH by SVC battery/company	E
QTY-AUTH by numbered battery/company and similar	F

HQ performing ORG maintenance for other units

d. Control 1 N F -

A code 1-9 used for sequencing and controlling BOI entries.

031 BUILT-IN-TEST CANNOT DUPLICATE PERCENTAGE 2 N R -

The percent of all Built-in-Test (BIT) indicated malfunctions provided during usage of the equipment that cannot be verified by maintenance personnel performing on-equipment troubleshooting.

032 BUILT-IN-TEST DETECTABILITY LEVEL PERCENTAGE 2 N R -

A BIT consists of an integral capability of the mission equipment which provides an onboard automated test capability to detect, diagnose, or isolate system failures. The fault detection/isolation capability is used for momentary or continuous monitoring of a system's operational health, and for observation/diagnosis as a prelude to maintenance action. BIT subsystems may be designed as an analysis tool for the overall system, integrated with several subsystems, or may be designed as an integral part of each removable component. Detectability Level Percentage is the probability that the malfunction or failure of the UUT will be detected by BIT multiplied by 100.

033 BUILT-IN-TEST RETEST OK PERCENTAGE 2 N R -

The percent of items removed from an end item as a result of BIT indicated malfunction that subsequently pass all related testing at the next maintenance level (e.g., intermediate shop).

034 CALIBRATION AND MEASUREMENT REQUIREMENTS SUMMARY PARAMETER CODE 1 A F -

MIL-STD-1388-2B
APPENDIX E

A code specifying whether or not a specific parameter is to be included in the Calibration and Measurement Requirements Summary (CMRS).

Parameter is included in the CMRS Y
Parameter is not included in the CMRS N

035 CALIBRATION AND MEASUREMENT REQUIREMENTS 1 X F -
SUMMARY RECOMMENDED

A field depicting whether or not a Calibration and Measurement Requirements Summary is recommended. Codes are as follows:

Calibration and Measurement Requirements Y
Summary (CMRS) recommended
Not recommended for CMRS N

UUT CALIBRATION AND MEASUREMENT REQUIREMENTS SUMMARY RECOMMENDED CODE.
A CMRS recommendation code for the unit under test.

036 CALIBRATION AND MEASUREMENT REQUIREMENTS 1 A F -
SUMMARY STATUS

A code to indicate if a Calibration and Measurement Requirements Summary (CMRS) has been previously developed or is in process for the subject item. Codes are as follows:

Yes Y
No N

UUT CALIBRATION AND MEASUREMENT REQUIREMENTS SUMMARY STATUS. The CMRS status of the UUT.

SE UUT CMRS STATUS. The CMRS status of the SE UUT.

037 CALIBRATION INTERVAL 2 N R -

The frequency in months between which a support/test equipment must be calibrated in order to operate within specified tolerances.

038 CALIBRATION ITEM 1 A F -

A single position code indicating that the item recommended is itself an item of calibration equipment.

Item is a calibration item Y
Item is not a calibration item N

039 CALIBRATION PROCEDURE 20 X L -

The technical manual/order number or instructions that specifies the calibration procedure. For items of TMDE that have an approved method of support, list the applicable military department approved calibration procedure, technical order, or maintenance technical order in the item name block.

MIL-STD-1388-2B
APPENDIX E

- 040 CALIBRATION REQUIRED 1 A F -
A single position code indicating whether the support/test equipment recommended or procured requires calibration.
Calibration required Y
Calibration not required N
- 041 CALIBRATION STANDARD 1 A F -
Indicates the requirement of the support/test equipment to be calibrated using a standard.
Standard required Y
Standard not required N
- 042 CALIBRATION TIME 5 N R 1
The time, in hours, required to calibrate the support/test equipment.
- 043 CHANGE AUTHORITY NUMBER 15 X L -
A number to uniquely identify an authority for an engineering change. The change authority and a numbering sequence will be provided by the requiring authority.
- 044 CHARACTERISTICS OF SUPPORT EQUIPMENT 240 X - -
Narrative information about the operational characteristics of the SE, including minimum and maximum capabilities, of the selected support and test equipment or training device. Any critical or limiting characteristics that must be considered before substitution of a similar item must also be included. Narrative specifics might include equipment type; units of measurement; degrees of measurement; and parameters ranges and tolerances. If operational characteristics are classified, state so in this block.
- 045 CLEANING AND DRYING PROCEDURE 1 X F -
A code which identifies the procedure for removing soil from parts and the procedure to accomplish the subsequent drying of the cleaned part. For applicable codes, see MIL-STD-2073-1 and MIL-STD-2073-2.
- 046 COMMERCIAL AND GOVERNMENT ENTITY (CAGE) CODE 5 X F -
A five-character code assigned by the Defense Logistics Services Center (DLSC) to the design control activity or actual manufacturer of an item as contained in the Cataloging Handbook H4/H8 Series.
ADAPTER INTERCONNECTOR DEVICE CAGE CODE. A CAGE of the adapter interconnector device used in conjunction with the SE.
ARN CAGE CODE. A CAGE of the additional reference number.

MIL-STD-1388-2B
APPENDIX E

ARN ITEM CAGE CODE. A CAGE of the primary item reference number.

ATE CAGE CODE. A CAGE of the automated test equipment.

CTIC CAGE CODE. A CAGE associated with the CTIC.

INTEROPERABLE CAGE CODE. A CAGE of the interoperable item.

ITEM CAGE CODE. A CAGE of the primary item reference number.

OPERATIONAL TEST PROGRAM CAGE CODE. A CAGE of the operational test program used in conjunction with the SE.

PACKAGING DATA PREPARER CAGE. A CAGE of the packaging data preparer.

S/N PROVISIONING CAGE CODE. A CAGE of the provisioned item under analysis having a serial number relationship.

SUPERCEDEURE CAGE CODE. A CAGE of the SE that is superceding or being superceded by the SE under analysis.

SUPPORT EQUIPMENT CAGE CODE. A CAGE of the SE under analysis.

SUPPORT EQUIPMENT UNIT UNDER TEST CAGE CODE. A CAGE of the SE that is also a calibration and measurement requirements summary category II item.

SYSTEM CAGE CODE. A CAGE of the system equipment item which is identical to the SE.

TASK SUPPORT CAGE CODE. A CAGE of the SE identified for a given task.

TASK PROVISION CAGE CODE. A CAGE of the support item which is being provisioned.

TEST PROGRAM INSTRUCTION CAGE CODE. A CAGE of the test program instruction used in conjunction with the operational test program.

TESTING SUPPORT EQUIPMENT CAGE CODE. A CAGE of the support equipment (SE) which measures the SE unit under test.

UOC PROVISIONING CAGE CODE. A CAGE of the provisioned item under analysis having a UOC relationship.

047 COMMERCIAL AND GOVERNMENT ENTITY 102 X - -
CODE ADDRESS

The manufacturer or government address represented by the CAGE Code. It is divided into 6 subfields.

- a. CAGE name 25 X L -
- b. CAGE P.O. box number/street 25 X L -
- c. CAGE city 20 X L -

MIL-STD-1388-2B
APPENDIX E

	d. CAGE state	2 A F -
	e. CAGE nation	20 X L -
	f. CAGE postal zone	10 X L -
048	COMMON UNIT UNDER TEST	2 N R

The number of UUTs with which the adapter, interconnection device or signal conditioning circuitry can be used.

049	COMPENSATING DESIGN PROVISIONS	65 X - -
-----	--------------------------------	----------

A narrative description identifying design provisions which circumvent or mitigate the effects of the failure. A record of the true behavior of the item in the presence of an internal malfunction or failure. Features of the design at any indenture level that will nullify the effects of a malfunction or failure, control or deactivation system items to halt generation or propagation of failure effects, or activate backup or standby items or systems. Redesign compensating provisions include:

- a. Redundant items that allow continued and safe operation.
- b. Safety or relief devices such as monitoring or alarm provisions which permit effective operation or limit damage.
- c. Alternate models of operation such as backup or standby items or systems.

050	COMPENSATING OPERATOR ACTION PROVISIONS	65 X L -
-----	---	----------

A narrative description describing operator actions to circumvent or mitigate the effect of the postulated failure. Describes the compensating provision that best satisfies the indication(s) observed by an operator when the failure occurs, and the consequences of any probable incorrect action(s) by the operator in response to an abnormal indication.

051	CONCURRENT PRODUCTION CODE (CPC)	1 A F -
-----	----------------------------------	---------

A code to indicate if the unit of measure or issue price and lot quantity are based on concurrent production of the spare item with the weapon system/end item production.

Based on concurrent production	Y
Not based on concurrent production	N

UI PRICE CONCURRENT PRODUCTION CODE. The CPC associated with the UI price.

UM PRICE CONCURRENT PRODUCTION CODE. The CPC associated with the UM price.

052	CONTACT TEAM DELAY TIME	3 N R -
-----	-------------------------	---------

MIL-STD-1388-2B
APPENDIX E

The time (in hours) required for a contact team to travel from the intermediate maintenance location to the organizational location.

053 CONTAINER LENGTH 2 N R -

The smallest standard container, in feet, that can be used to transport the system/equipment.

054 CONTAINER TYPE 36 X L -

The designation of the standard container used to transport the system/equipment, e.g., ANSI/ISO, European.

055 CONTRACT NUMBER 19 X L -

The unique number assigned to the contract in question, by which it can be specifically identified.

SUPPORT EQUIPMENT CONTRACT NUMBER. The contract number of the SE development/procurement.

TRANSPORTATION CONTRACT NUMBER. The contract number for shipping.

056 CONTRACTOR FURNISHED EQUIPMENT/
GOVERNMENT FURNISHED EQUIPMENT (CFE/GFE) 1 A F -

A single-position code indicating the contractor's recommendation for supply action.

Contractor Furnished C
Government Furnished G

057 CONTRACTOR RECOMMENDED 1 A F -

A code to signify whether or not the corresponding requirements are contractor recommended. Codes are as follows:

YES "Y"
NO "N"

058 CONTRACTOR TECHNICAL INFORMATION CODE 2 A - -
(CTIC)

A code which indicates specific information regarding the technical process/data required to procure or produce the support item.

a. The first position of the CTIC contains a Breakout Recommendation Code. For a Navy acquisition program the only applicable code is "C", which does not relate to first position code "C" of this DED.

Recommended for Breakout A
Not Recommended for Breakout - Safety B
Not Recommended for Breakout - Warranty C
Not Recommended for Breakout - Unstable Design D

MIL-STD-1388-2B
APPENDIX E

Not Recommended for Breakout - Value Added E
Not Recommended for Breakout - Other/Combination F

Note: If code "F" is used, remarks block of provisioning list will contain elaboration.

b. Codes for the second position are as follows:

Source(s) are specified on "Source Control", B
"Altered Item", or "Selected Item" drawings/documents.
(The contractor shall furnish a list of the sources
with this code as additional reference numbers and CAGEs.)

Requires engineering source approval by the design C
control activity in order to maintain the quality
of the part. An alternate source must qualify IAW
the design control activity's procedures, as approved
by the cognizant government engineering activity

There are no technical restrictions to competition. G

Produced from class 1A castings (e.g., class 1 of K
MIL-C-6021) and similar type forgings. The process
of developing and proving the acceptability of
high-integrity casting and forgings requires
repetitive performance by a controlled source.
Each casting or forging must be produced along
identical lines to those which resulted in initial
acceptability of the part. The contractor shall
furnish a list of known sources for obtaining
casting/forgings with this code.

Master or coordinated tooling is required to pro- M
duce this part. This tooling is not owned by the
government or, where owned, cannot be made available
to other sources. The contractor shall furnish a
list of the firms possessing the master or
coordinated tooling with this code.

Requires special test/inspection facilities N
to determine and maintain ultra-precision quality
for function or system integrity. Substantiation
and inspection of the precision or quality cannot
be accomplished without such specialized test or
inspection facilities. Other sources in industry do
not possess, nor would it be economically feasible for
them to acquire facilities. The contractor shall furnish
a list of the required facilities and their locations
with this code.

The rights to use the data needed to purchase this P
part from additional sources are not owned by the
Government and cannot be purchased.

MIL-STD-1388-2B
APPENDIX E

A high reliability part under a formal reliability program. Probability of failure would be unacceptable from the standpoint of safety of that personnel/equipment. The cognizant engineering activity has determined that data to define and control reliability limits cannot be obtained, nor is it possible to draft adequate specifications for this purpose. Continued control by the existing source is necessary to ensure acceptable reliability. (The contractor shall identify the existing source with this code as additional numbers and CAGES.) V

The design of this part is unstable. Engineering, manufacturing, or performance characteristics indicate that the required design objectives have not been achieved. Major changes are contemplated because the part has a low process yield or has demonstrated marginal performance during tests or service use. These changes will render the present part obsolete and unusable in its present configuration. Limited acquisition from the present source is anticipated pending configuration changes. The contractor shall identify the existing source with this code as a reference/additional reference number and CAGE. Y

059 CONVERSION FACTOR 5 N - -

A factor (with a decimal locator code) used to convert the AOR of the system/equipment to the AOR of the item under analysis. The factor is obtained by dividing the rate of usage of the item under analysis (expressed in cycles, miles, rounds, hours, or any other appropriate measurement base) by the rate of usage of the system/equipment (also expressed in the same Measurement Base). Consists of the following subfields:

a. First Position: 1 N F -
Decimal Locator Code

The location, from the right, of the implied decimal point for the multiplier entered in positions 2 through 5, i.e., the number of decimal places.

Integer Number (no decimal places)	0
1 Decimal place	1
2 Decimal places	2
3 Decimal places	3
4 Decimal places	4

b. Positions 2 through 5: 4 N R AS
Multiplier

The multiplier used in the conversion.

060 COORDINATED TEST PLAN (CTP) 1 A F -

MIL-STD-1388-2B
APPENDIX E

A single-letter code which indicates whether the CTP is adequate to verify the suitability of the requested item for military application.

Adequate Y
Not Adequate N

061 COST PER REORDER ACTION 4 N R 2

The administrative cost in dollars and cents to prepare, advertise, and award a contract/purchase order/basic order agreement for wholesale supply reorder actions.

062 COST PER REQUISITION 4 N R 2

The administrative cost in dollars and cents to prepare and submit a requisition for a replenishment spare/repair part.

063 CREST ANGLE 2 N R -

The angle in degrees that a wheeled vehicle can approach, negotiate, and depart a ramp 15-feet long connecting two horizontal surfaces.

064 CREW SIZE 4 N R -

The number of personnel assigned to operate a system/equipment.

065 CRITICAL ITEM CODE 13 X L -

A series of codes assigned at item assembly level when one or more components comprising the assembly item contain critical/strategic material or when the assembly item as a purchased part meets one or more reasons for criticality IAW MIL-STD-295. When two or more reasons for criticality apply all applicable codes will be provided.

a.	<u>Position 1</u>	<u>Component Designator</u>
	Purchased part	P
	Material content	M
	Both purchased part and material content	B
b.	<u>Positions 2-13</u>	<u>Reason for Criticality</u>
	Surge capacity	CA
	Cost	CO
	Foreign dependency	FD
	Foreign source	FS
	Long lead time	LL
	Production quality	PQ
	Sole/single source qualified	SQ

066 CRITICALITY CODE 1 A F -

A code which indicates that an item is technically critical by reason of tolerance, fit restrictions, application, nuclear hardness properties or characteristics which affects identification of the item.

MIL-STD-1388-2B
APPENDIX E

	The item has critical features such as tolerance fit restrictions or application. Nuclear hardness properties have not been determined.	C
	The item does not have a critical feature such as tolerance, fit restrictions, or application. Nuclear hardness properties have not been determined.	N
	The item is specifically designed to be selected as being nuclear hard (i.e., it will continue to perform its designed function in an environment created by nuclear explosion). The item does not have other critical features.	H
	The item is specifically designed to be selected as being nuclear hard. In addition the item has other critical features such as tolerance, fit restrictions, or application.	M
	The item does not have a nuclear hardened feature or any other critical feature such as tolerance, fit restriction, or application.	X
	The item does not have a nuclear hardened feature but does not have other critical feature(s) such as tolerance, fit restrictions or application.	Y
067	CUSHIONING AND DUNNAGE MATERIAL CODE	2 X F -
	A code which identifies resilient material employed for the purpose of absorbing shock and preventing damage to the item or material used for preventing movement of the item within the package. For applicable codes, see MIL-STD-2073-1 and MIL-STD-2073-2.	
068	CUSHIONING THICKNESS	1 X F -
	A code which indicates the minimum thickness of material used to cushion the item. For applicable codes, see MIL-STD-2073-1 and MIL-STD-2073-2.	
069	CUSTODY CODE	1 A F -
	A one-character code identifying calibration management and usage of support equipment to be obtained from the supporting intermediate maintenance activity. The codes are as follows:	
	Items used infrequently (less than once per month), and indicates the item is available from the supporting intermediate maintenance activities as required.	E
	Items weighing over 200 pounds (over 300 pounds for wheeled equipment), exceeding any one of the following dimensions in a stowed configuration: 6' X 3' X 2', fragile or subject to misalignment or loss of calibra-	P

MIL-STD-1388-2B
APPENDIX E

tion through transportation, or not coded for infrequent use.

All items requiring calibration and management, designated for use at the organizational level of maintenance, and not already coded "E" or "P". L

Items listed only in a detachment list code requiring management, and having a custody code of "E" or "P". D

Noncalibratable items requiring management that are not otherwise custody coded. M

Items that do not require calibration or management and consequently not otherwise custody coded. N

070 DATA STATUS CODE 1 A F -

A code indicating the status of the data for provisioning.

Contractor reviewed C
Government approved G
Completed-Ready for provisioning R

071 DATE 6 N F -

The date of an event, expressed as the year (last two positions), month and day of the event, e.g., YYMMDD.

DATE OF FIRST ARTICLE DELIVERY. A date when the first SE under analysis is delivered and available for use.

REVISION DATE. A date when the transportability data was last revised.

SERD DATE OF INITIAL SUBMISSION. A date when the support equipment recommendation data (SERD) was initially submitted.

SERD DATE OF GOVERNMENT DISPOSITION. A date of disposition action by the government.

SERD DATE OF REVISION SUBMISSION. A date when a revised SERD was submitted.

072 DECK STOWAGE 1 A F -

A code indicating if the deck stowage is permissible.

Yes Y
No N

073 DEFENSE LOGISTICS SERVICES CENTER 1 A F -
SCREENING REQUIREMENT CODE

MIL-STD-1388-2B
APPENDIX E

A code which is used to categorize items and to determine whether or not the item requires DLSC screening IAW DOD 4100.38-M.

New Design Item/New Reference Number not requiring DLSC screening	A
Item previously screened through DLSC	B
Military Specification Type Item	C
Government Furnished Equipment	D
Vendor/Commercially Furnished Item	E

074 DEGREE OF PROTECTION CODE 1 A F -

A code to indicate the level of protection which the package requirement provides the item during shipment, handling, and storage. For code explanations, see MIL-STD-2073-1 and MIL-STD-2073-2.

Level A	A
Level B	B
Level C	C

075 DELIVERY SCHEDULE 1 A F -

A code that indicates if the transportation by fiscal year is needed.

Required	Y
Not required	N

076 DEMILITARIZATION CODE (DMIL) 1 A F -

A code which indicates the degree of demilitarization required for an item. For applicable codes, see DOD 4100.38-M.

077 DEMILITARIZATION COST 2 N R -

The estimated cost to demilitarize an item expressed as a percentage of the cost of the item.

078 DESCRIPTION AND FUNCTION OF SUPPORT EQUIPMENT 65 X - -

A narrative description of the SE required to satisfy the functional requirements of the end article. The specific operating critical and functional performance characteristics, corresponding tolerance of accuracy, and design criteria necessary to satisfy the functional requirements. Information regarding material finish, fragility, service requirements, etc., shall be included. For items representing or containing peculiar material requiring special treatment, precautions, or management control of the item, enter the Special Material Content Code (listed in DOD 4100-38-M).

MIL-STD-1388-2B
APPENDIX E

- 079 DESIGN DATA CATEGORY CODE 1 A F -
A code indicating the design data being considered, which are recommended or not recommended by the contractor or government. Codes are as follows:
- | | |
|--|---|
| Support Equipment (SE) Standardization | A |
| SE Specification | B |
| Design Engineering | C |
| Configuration Control | D |
| Reliability | E |
| Maintainability | F |
| Quality Assurance | G |
| Safety | H |
| Human Engineering | I |
| Test and Evaluation | J |
| Computer Resources | K |
| SE Illustration | L |
| Other | M |
- 080 DESIGN DATA PRICE 8 N R -
The total expected price, for budgetary planning, associated with contractor-recommended hardware/software design activities.
- 081 DESIGNATED REWORK POINT (DRP) 12 X - -
A code which identifies the depot level repair facility responsible/designated for repair, rework, or renovations of a repairable item. The
DRP field is composed of two subfields, allowing entry of two codes.
- | | |
|--------------------|---------|
| a. First subfield | 6 X L - |
| b. Second subfield | 6 X L - |
- 082 DISASTER RESPONSE FORCE 65 X L -
A narrative identification of all disaster response force requirements for a transportation disaster encountered while transporting the item (e.g., security, firefighting, medical).
- 083 DISCOUNT RATE 3 N R 2
The effective rate of return on an investment after adjusting for inflation to discount future costs.
- 084 DISPOSITION 10 X AS -
This is a 10 block spread format, each disposition will consist of a one 1 position block. The conclusions reached as the outcome of the Reliability Centered Maintenance (RCM) analysis; specifically, the maintenance requirements that have been determined to be appropriate for the referenced Failure Mode, as the result of the application of a particular set of RCM logic.

MIL-STD-1388-2B
APPENDIX E

085 DISTANCE 4 N R -

The geographical distance, in miles between two points.

086 DOCUMENT AVAILABILITY CODE (DAC) 1 X F -

A code which indicates the availability of technical documentation for the reference number as an item of identification IAW table 5 of DOD 4100.38-M.

087 DOCUMENT IDENTIFIER CODE (DIC) 3 A F -

A code that identifies the match conditions resulting from prescreening reference number searches outlined in DOD 4100.38-M. These codes are commonly referred to as Match Indicator Codes. Following are the type of match conditions to be output as the result of reference number searches, and the DIC under which the output will be produced.

Actual Match. Output against "P" type LSR screening requests only. The input matched only one National Stock Number (NSN)/Permanent System Control Number (PSCN) in the Defense Logistics Services Center (DLSC) files under the rules of the Defense Integrated Data System (DIDS) Reference Number Category Code (RNCC)/Reference Number Variation Code (RNVC) validation criteria. No probable matches were encountered and no possible matches encountered will be output (only the highest degree of match encountered will be output). KMH

Probable Match. Output against "P" type LSR screening request only. The input matched more than one NSN/PSCN in the DLSC files under the rules of the DIDS RNCC/RNVC validation criteria. An actual match was not encountered and no possible matches encountered will be output. KMQ

Possible Match. Output against "P" type LSR screening request only. The input matched a NSN/PSCN in the DLSC files, but the match did not meet the DIDS RNCC/RNVC criteria required to produce either an actual or probable match condition. KMG

Exact Match. Output against "F" and "S" type screening requests only. All CAGE codes/PSCNs and reference numbers submitted under the same submitter's control number, matched a single NSN/PSCN to which there were no additional or fewer reference numbers credited, than those submitted. KME

Association Match. The input matches an NSN/PSCN in the DLSC files by a CAGE (through a corporate association relationship code) other than the CAGE KMA

MIL-STD-1388-2B
APPENDIX E

submitted. Association matches will be considered to be the same degree of match as possible or partial matches.

NATO NSN Match. Input matched against a stock number assigned by a NATO country other than the United States. The NSN only is provided. KMN

Partial Match. Output against "F" and "S" type screening only. CAGE and reference numbers submitted under the same Submitter's Control Number matched one or more NSN/PSCN to which there were more or fewer reference numbers credited than those submitted. KMP

Security Classified Item Match. This output DIC indicates that the submitted reference number matched an item that is security classified. No file data will be output. KMS

Preferred Item Data. Total Item Record (TIR) data is forwarded for the standard or replacement NSN/PSCN, which is related to a nonstandard NSN identified by the screening. TIR data is provided for review of the adequacy of the substitute item. KMT

No Match. The input did not match an NSN/PSCN in the DLSC files; or, for "P" type screening request, the degree of match was not relevant to the type of match requested. KNR

088 DRAWING CLASSIFICATION 3 X - -

A three-position code used to indicate the category and form or level of the engineering drawings used in the analysis. The code is divided into three subcategories as follows:

a. Position 1. Intended Use Categories

Design evaluation	A
Interface control	B
Service test	C
Logistic support	D
Procurement (identical items)	E
Procurement (interchangeable items)	F
Installation	G
Maintenance	H
Government manufacture	I
Interchangeability control	J

b. Position 2. Drawing Level

MIL-STD-1388-2B
APPENDIX E

Conceptual and development design	1
Production prototype and limited production	2
Production	3

c. Position 3: Proprietary Status. Facility drawings will not be coded as proprietary without prior review and approval of the requiring authority.

Proprietary	Y
Nonproprietary	N

FACILITY DRAWING CLASSIFICATION. The drawing classification of the facility drawing.

089 DRAWING NUMBER 32 X L -

A designation assigned to a particular drawing by the design activity for identification purposes. The drawing number may include numbers, letters, and dashes with the following limitations:

Letters "I", "O", "Q", "S", "X", and "Z" shall not be used; however, letters "S" and "Z" may be used only if they are a part of the existing drawing numbering system. They shall not be used in the development of new drawing numbering systems. Letters shall be upper case (capital letters).

Numbers shall be Arabic numerals. Fractional, decimal, and Roman numerals shall not be used.

Blank spaces are not permitted.

Symbols such as: parenthesis (), asterisk *, virgule /, degree ', plus +, minus -, shall not be used, except when referencing the government or nongovernment standardization document whose identification contains such a symbol.

The CAGE, drawing format size letter, and drawing revision letter (see DOD-STD-100, paragraphs 503.2 and 602.3) are not considered part of the drawing number or part number.

A system based on a significant numbering system or a sequentially assigned nonsignificant numbering system designed to preclude duplication is acceptable.

FACILITY DRAWING NUMBER. The drawing number of the facility.

090 DUTY 240 X L -

A set of operationally related tasks within a given JOB, DED 185, e.g. driving, weapon servicing, communicating, and operator maintenance.

091 DUTY CODE 4 X L -

An assigned code which is associated with a specific duty.

MIL-STD-1388-2B
APPENDIX E

092 DUTY POSITION REQUIRING A NEW OR REVISED SKILL 19 X L -

The title of an occupation for which a new SSC is required.

093 ECONOMIC ANALYSIS 1 A F -

A single letter which indicates whether a systematic approach to employing scarce resources in a most efficient and effective manner has been performed.

Analysis completed Y
Analysis not completed N

094 EDUCATIONAL QUALIFICATIONS 65 X - -

A narrative description identifying the educational prerequisites recommended to acquire the skill necessary to perform the task or attain the SSC (i.e., academic, subjects, specialized subjects, specialized degrees, and licenses, etc.)

095 ELEMENT INDICATOR 1 A F -

A single-position code to indicate whether or not the procedural step is a task element.

Task Element: The smallest logically and reasonably definable unit of behavior required to complete a task or subtask. E

Not a Task Element Blank

096 END ITEM ACRONYM CODE (EIAC) 10 X L -

A code which uniquely identifies the system/equipment end item. This code will be assigned by the requiring authority. It will remain constant throughout the item's life cycle (e.g., TOW, PATRIOT, Tomahawk, Sparrow, and ALCM).

REFERENCED END ITEM ACRONYM CODE. An EIAC that contains referenced task information.

REFERENCED SUBTASK END ITEM ACRONYM CODE. An EIAC that contains referenced subtask information.

097 ENGINEERING FAILURE MODE MEAN TIME BETWEEN FAILURE (EFM-MTBF) 10 D - -

That portion of an item's MTBF (DED 229) that is attributable to an Engineering Failure Mode (Failure Cause, DED 124). EFM-MTBF may be calculated by the following formula:

$$\text{EFM-MTBF} = \frac{1}{\text{FMR} \times \text{FR}}$$

MIL-STD-1388-2B
APPENDIX E

Where: FMR = Failure Mode Ratio (DED 136) for the particular failure mode under analysis.
FR = Failure Rate for the LCN/ALC item under analysis.

098 ENVIRONMENTAL HANDLING AND 1 A F -
AND TRANSPORTATION INDICATOR

A code which indicates if an item will require special consideration to meet all environmental packaging, handling, storage, and transportation requirements.

Special consideration required Y
No special consideration required N

099 ENVIRONMENTAL/HAZARDOUS MATERIALS 65 X L -
CONSIDERATIONS

A narrative description identifying any special environmental considerations when an item is being transported or being designed for transportation. For each item classified as a hazardous material state the class of hazardous material as specified in Title 49, Code of Federal Regulations, parts 100-179, Transportation; AFR 71-4, Preparing Hazardous Materials for Military Air Shipments; International Maritime Good Code; or, International Civil Dangerous Goods by Air. Also state which of these documents were used to acquire the code(s).

100 ESSENTIALITY CODE 1 N F -

A code to indicate the degree to which the failure of the part affects the ability of the end item to perform its intended operation.

Failure to this part will render the end 1
item inoperable.

Failure to this part will not render the end 3
item inoperable.

Item does not qualify for the assignment 5
of code 1, but is needed for personnel safety.

Item does not qualify for assignment of 6
code 1, but is needed for legal, climatic, or
other requirements peculiar to the planned
operational environment of the end item.

Item does not qualify for the assignment of 7
code 1, but is needed to prevent impairment
of or the temporary reduction of operational
effectiveness of the end item.

101 ESTIMATED PRICE 8 N R -

An estimated cost associated with each contractor-recommended requirement for budgeting and planning.

MIL-STD-1388-2B
APPENDIX E

- 102 ESTIMATED SALVAGE VALUE 2 N R -
The estimated end of life salvage value expressed as a percentage of the cost of the item.
- 103 EXTENDED UNIT PRICE 8 N R -
The total proposed or estimated price for an item. The extended unit price is calculated by multiplying the Total Quantity Recommended by the Recurring Cost per unit, adding the Nonrecurring Cost to their product, then dividing the sum by the Total Quantity Recommended.
- 104 EXTERNAL OR INTERNAL LOAD INDICATOR 1 A F -
A code which indicates how the aircraft/helicopter will transport the system/equipment.
External A
Internal B
Both external and internal C
- 105 FACILITIES DESIGN CRITERIA 65 X - -
A narrative description identifying the facility design requirements necessary to support a specific task code applicable to the item under analysis. The design criteria are in terms such as axle loads, hoist requirements, and special handling, installation, storage, electrical, environmental, or service requirements.
- 106 FACILITIES INSTALLATION LEAD TIMES 65 X - -
A narrative description identifying facilities installation lead time schedules for contractor produced and installed support and test equipment or training devices. Lead times are referenced to system/equipment delivery schedules rather than to calendar dates (expressed in days, weeks, or months).
- 107 FACILITIES MAINTENANCE REQUIREMENTS 65 X - -
A narrative description identifying the maintenance concept for the system, e.g., number of maintenance levels, and identifying the facilities that are required to maintain the system at the applicable maintenance levels.
- 108 FACILITIES REQUIREMENTS 65 X - -
A narrative description identifying the location of and the functions to be performed in the facility. Identifies environmental consideration affecting health, sanitation, or the surrounding community.
- 109 FACILITIES REQUIREMENTS FOR OPERATIONS 65 X - -
A narrative description identifying if the system is to be used or operated in garrison or on a day-to-day basis and if such, what

MIL-STD-1388-2B
APPENDIX E

facilities are needed to support the system in its daily use, i.e., runways, helipads, clear zones, commercial power, operational pads, etc.

110 FACILITIES REQUIREMENTS FOR TRAINING 65 X - -

A narrative description identifying what facilities are required for training; classrooms, ranges, maneuver areas; and, facilities for simulators or other training devices.

111 FACILITIES UTILIZATION 65 X - -

A narrative description identifying the facility utilization rate in terms of number of tasks performed in the facility, training sessions, flying hours, number of maintenance hours, and other appropriate designators per specified time period.

112 FACILITY AREA 6 N R -

A numeric value describing the size of a designated space such as a shop, building, or land parcel in units contained in the associated Unit of Measure.

113 FACILITY BASELINE NARRATIVE CODE 1 A F -

A code that indicates the facility baseline narrative.

Facilities maintenance requirements, DED 107	A
Facilities requirement for operations, DED 109	B
Facility requirements for training, DED 110	C
Facility requirements: special considerations, DED 120	D
Facility requirements: supply/storage, DED 121	E

114 FACILITY CAPABILITY 65 X L -

A narrative description identifying the capacity impact of the work load upon the facility.

115 FACILITY CATEGORY CODE 6 N L -

Provides a method for identifying and classifying real property from the initial planning stages through the complete cycle of programming, budgeting, accounting, and reporting in the areas of acquisition, construction, inventory, and maintenance. Every reportable item of real property is considered a facility. A parcel of land is a facility, as is each building, structure, and utility constructed on or in the land. The three-digit DOD Basic Category codes have been extended within the services by additional digits. The more definitive categorization is authorized by DOD for internal use within the DOD components (see AR 415-28, NAVFAC P-72, or AFM 86-1 for codes).

BASELINE FACILITY CATEGORY CODE. The facility category code of the baseline facility.

MIL-STD-1388-2B
APPENDIX E

NEW OR MODIFIED FACILITY CATEGORY CODE. The facility category code of the new or modified facility.

116 FACILITY CLASSES 19 X L -

This is the short name used in conjunction with the facility category code within AR 415-28, NAVFAC P-72, and AFM 86-1 for identifying facility real property.

117 FACILITY LOCATION 65 X L -

A narrative description identifying the existing, new, or modified facility in terms of where the facility is located (e.g., depot name, building, post, bay, etc.).

118 FACILITY NAME 32 X L -

An identification of the name of the facility type that the system/equipment requires.

BASELINE FACILITY NAME. The name of the baseline facility.

NEW OR MODIFIED FACILITY NAME. The name of the new or modified facility.

119 FACILITY NARRATIVE CODE 1 A F -

A code that indicates the facility narrative.

Facility capability, DED 114 A
Facility location, DED 117 B

120 FACILITY REQUIREMENTS: SPECIAL CONSIDERATIONS 65 X - -

A narrative description identifying any special considerations which impact facilities. It is used to describe special problems which apply to facilities requirements. Such items may consist of item weight, turning radius, environmental impacts, and security requirements. Also, information concerning facility requirement interrelationships which identifies advantages of close proximity to other facilities from a functional/ efficiency standpoint or site restrictions such as quantity distance criteria is identified.

121 FACILITY REQUIREMENTS: SUPPLY/STORAGE 65 X - -

A narrative description identifying where the system will be stored, e.g., arms room, motor pool; if there are any special storage requirements for the system or components; e.g., security, environmental controls, warehouse, covered, uncovered, or if there is any impact in other storage facilities; e.g., petroleum, oil, lubricants, munitions.

122 FACILITY TASK AREA BREAKDOWN 65 X - -

MIL-STD-1388-2B
APPENDIX E

A narrative description identifying the breakdown of a facility area by individual tasks at the job level to determine maximum use of space.

123 FACILITY UNIT COST RATIONALE 65 X - -

A narrative description identifying variations to the appropriate unit cost contained in military construction pricing guides, in terms of differences because of unusual utilities requirements, or other special features. When a suitable unit cost is not available, provide a unit cost estimate for each facility item.

124 FAILURE CAUSE 65 X - -

All probable independent causes for each failure mode shall be identified and described. The failure causes within adjacent indenture levels shall be considered. For example, failure causes at the third indenture level shall be considered when conducting a second indenture level analysis.

125 FAILURE/DAMAGE EFFECTS: END EFFECT 65 X - -

A narrative description identifying the consequences of each failure/damage mode, on item operation, function, or status. Failure/damage effects focus on the specific block diagram element, which is affected by the condition under consideration. End effects evaluate and define the total effect a failure/damage mode has on the operation, function, or status of the uppermost system. The effect of each failure/damage mode upon the essential functions(s) affecting system/equipment operating capability and mission completion capability shall be determined. The end effect described may be the result of a double failure. For example, failure of a safety device may result in a catastrophic end effect only in the event that both the prime function goes beyond the limit for which the safety device is set, and the safety device fails.

126 FAILURE/DAMAGE EFFECTS: LOCAL 65 X - -

A narrative description identifying the consequences of each failure/damage mode, on item operation, function, or status. Failure/damage effects focus on the specific block diagram element, which is affected by the condition under consideration. Local effects concentrate specifically on the impact a failure/damage mode has on the operation and function of the item in the indenture level under consideration. The consequences of each postulated failure/damage mode affecting the item shall be described along with any second order effects which result. Potential conditions where the failure/damage of one item results in a change of the conditional failure probability, or effect of a second item shall be identified. It is possible for the "local effect" to be the failure/ damage mode itself.

127 FAILURE/DAMAGE EFFECTS: NEXT HIGHER 65 X - -

A narrative description identifying the consequences of each failure/damage mode, on item operation, function, or status. Failure/damage effects focus on the specific block diagram element, which is affected by

the condition under consideration. These effects concentrate on the impact a failure/damage mode has on the operation and function of the items in the next higher indenture level above the indenture level under consideration. The consequences of each failure/damage mode affecting the next higher indenture level shall be described.

128 FAILURE/DAMAGE MODE

65 X - -

1. Failure modes: The manner by which a failure occurs. All predictable failure modes for each indenture level analyzed shall be identified and described. Potential failure modes shall be determined by examination of item outputs and functional outputs identified in applicable block diagrams and schematics. Failure modes of the individual item function shall be postulated on the basis of the stated requirements in the system definition and the failure definitions included in the ground rules developed to support the Failure Modes, Effects, and Criticality Analysis (FMECA) approach. Where functions shown on a block diagram are performed by a replaceable module in the system, a separate Failure Modes and Effects Analysis (FMEA) shall be performed on the internal functions of the module, viewing the module as a system. The effects of possible failure modes in the module inputs and outputs describe the failure modes of the module when it is viewed as an item within the system. Each failure mode and output function is examined in relation to the following typical failure conditions:

- a. Premature operations
- b. Failure to operate at a prescribed time
- c. Intermittent operation
- d. Failure to cease operation at a prescribed time
- e. Loss of output or failure during operation
- f. Degraded output or operational capability
- g. Other unique failure conditions, as applicable, based upon system characteristics and operational requirements or constraints

2. Damage Modes: A narrative description identifying all possible damage modes which could result from exposure to specified threat mechanism(s) determined through analysis of each subsystem, component, or part. The analysis includes both primary and secondary damage effects. Damage modes of individual item functions are postulated on the basis of the stated mission requirements, specified threats, and system descriptions. The effects of the possible damage modes include performance degradation, as well as total item failure. Each damage mode and function is examined in relation to the following typical damage conditions:

- a. Penetrated
- b. Severed
- c. Shattered, cracked
- d. Jammed
- e. Deformed
- f. Ignited, detonated
- g. Burned out (i.e., electrical overload)
- h. Burned through (i.e., threat-caused fires)

MIL-STD-1388-2B
APPENDIX E

129 FAILURE DETECTION METHOD 65 X - -

The method(s) by which occurrence of a specific failure mode is detected by the operator or maintenance technician. Describes warning devices, if applicable, and other indications which make evident to the operator or technician that a system/equipment has malfunctioned or failed. If no indication exists, states if the undetected failure will jeopardize the mission objectives or personnel safety, and if the undetected failure allows the system to remain operational in a safe state, explores possible resulting second failure situations. Proper correlation of a system malfunction or failure may require identification of normal, as well as abnormal indications. Normal indications are those that are evident to an operator when the system is operating normally. Abnormal indications are those that are evident to the operator when the system has malfunctioned or failed.

130 FAILURE EFFECT PROBABILITY (B) 3 N R 2

The values are the conditional probability that the failure effect will result in the assigned Safety Hazard Severity Code (DED 354) given that the failure mode occurs. The values represent the analyst's judgment as to the conditional probability the loss will occur, and are quantified in general accordance with the following:

<u>Failure Effect</u>	<u>Value</u>
Actual loss	1.00
Probable loss	0.10 to 1.00
Possible loss	0.00 to 0.10
No effect	0.00

131 FAILURE MODE AND RELIABILITY CENTERED MAINTENANCE (RCM) NARRATIVE CODE 1 A F

A code that indicates the failure mode and RCM narrative.

Failure/damage mode effect end effect, DED 125	A
Failure/damage mode effect local, DED 126	B
Failure/damage mode effect next higher, DED 127	C
Failure cause, DED 124	D
Failure/damage mode, DED 128	E
Failure mode detection method, DED 129	F
Failure mode predictability, DED 138	G
Failure mode remarks, DED 137	H
Redesign recommendations, DED 426	I
RCM age exploration, DED 343	J
RCM reasoning, DED 346	K
RCM redesign recommendations, DED 426	L

132 FAILURE MODE CLASSIFICATION 1 A F -

A one-position code that categorizes the failure resulting from the identified failure mode as a technical or an operational failure.

MIL-STD-1388-2B
APPENDIX E

Technical T
Operational O

133 FAILURE MODE CRITICALITY NUMBER 10 D - -
(C_m)

C_m is that portion of the criticality number for an item, which accounts for a specific one of its failure modes under a particular severity classification. For a particular severity classification and operational phase, the C_m for a failure mode may be calculated with the following formula:

$$C_m = (B a F t) (1,000,000)$$

Where:

C_m = Criticality Number for Failure Mode
B = Failure Effect Probability, DED 130
a = Failure Mode Ratio, DED 136
F = Part Failure Rate, DED 140
t = Operating Time, DED 269

134 FAILURE MODE INDICATOR 4 X F -

The first position of the code describes whether the indicator is a failure mode (F) or damage mode (D). The next three positions of the code are alphanumeric, but not special characters. This four-position code links information on a table to a particular failure or damage mode.

FMT FAILURE MODE INDICATOR. A failure mode indicator against which either a corrective or preventive task is documented.

135 FAILURE MODE INDICATOR MISSION PHASE 1 A F -
CHARACTERISTICS NARRATIVE CODE

A code that indicates the failure mode indicator mission phase characteristics narrative.

Compensating design provisions, DED 049 A
Compensating operator actions provisions, DED 050 B

136 FAILURE MODE RATIO (a) 4 N R 3

The fraction of the failure rate of the part, related to the particular failure mode under consideration. The failure mode ratio is the probability expressed as a decimal fraction that the part or item will fail in the identified mode. If all potential failure modes of a particular part or item are listed, the sum of the "a" values for the part or item will equal one. Individual failure mode multipliers may be derived from failure rate source data or from test and operational data. If failure mode data are not available, the "a" values represent the analyst's judgment based upon an analysis of the item's functions.

137 FAILURE MODE REMARKS 65 X - -

MIL-STD-1388-2B
APPENDIX E

Narrative clarification of data pertaining to failure modes.

138 FAILURE PREDICTABILITY 65 X - -

Information on known incipient failure indicators (e.g., operational performance variations), which are peculiar to the item failure trends and permit predicting failures in advance.

139 FAILURE PROBABILITY LEVEL 1 A F -

A single-position code identifying the qualitative level assigned to the failure probability of occurrence. The levels are as follows:

Level A - Frequent. A high probability of occurrences during the item operating time interval. High probability may be defined as a single failure mode probability of occurrence equal to or greater than 0.20 of the overall probability of failure during the item operating time interval. A

Level B - Reasonably Probable. A moderate probability of occurrence during the item operating time interval. Reasonably probable may be defined as a single failure mode probability of occurrence which is 0.10 or more, but less than 0.20 of the overall probability of failure during the item operating time interval. B

Level C - Occasional. An occasional probability of occurrence during item operating time interval. Occasional probability may be defined as a single failure mode probability of occurrence which is 0.01 or more, but less than 0.10 of the overall probability of failure during the item operating time. C

Level D - Remote. An unlikely probability of occurrence during item operating time interval. Remote probability may be defined as a single failure mode probability of occurrence which is 0.001 or more, but less than 0.01 of the overall probability of failure during the item operating time. D

Level E - Extremely Unlikely. A failure whose probability of occurrence is essentially zero during item operating time interval. Extremely unlikely may be defined as a single failure mode probability of occurrence, which is less than 0.001 of the overall probability of failure during the item operating time. E

140 FAILURE RATE 10 D - -

MIL-STD-1388-2B
APPENDIX E

For a particular interval, the total number of failures within a population of an item divided by the total functional life of the population during the measurement interval. The definition holds for time, rounds, miles, events, cycles, or other measures of life units.

141 FAILURE RATE DATA SOURCE 32 X L -

The source of the failure rates used in the calculation of criticality numbers. Failure rate data can be obtained from sources such as appropriate reliability predictions, test and evaluation results, field data from past systems of similar design and environmental use, or failure rate data sources such as MIL-HDBK-217.

142 FAMILY GROUP 10 X L -

The noun name which describes the measurement requirements by functional category for the support/test equipment is abbreviated: sig gen, elec count, etc., for signal generator, electronic counter, etc., respectively (see DOD-STD-2121).

143 FAULT ISOLATION 5 N - -

Fault Isolation is a procedure employed to determine which particular unit or group of units is at fault for a malfunction or failure. Specific information related to the BIT capability to fault isolate is provided in the subfields of this block.

a. Ambiguity Group 2 N R -

A set of items at the same level of indenture having properties such that BIT can determine that at least one of the set is faulty, but is unable to determine which particular one.

b. Percent Failure 3 N R 1

The percent of an item's probable malfunctions, which can be isolated within a specific ambiguity group by means of BIT.

144 FIGURE NUMBER 4 X R -

A number assigned to identify a specific illustration contained in a manual.

145 FISCAL YEAR (FY) 2 N F -

The period beginning October 1 of one calendar year and ending on September 30 of the following calendar year. The fiscal year is designated by the calendar year in which it ends.

TRANSPORTED FISCAL YEAR. The fiscal year for which transportation is required.

UI PRICE FISCAL YEAR. The fiscal year the UI price was developed.

MIL-STD-1388-2B
APPENDIX E

- UM PRICE FISCAL YEAR. The fiscal year the UM price was developed.
- 146 FREIGHT CLASSIFICATION 7 X L -
- The recommended freight classification of the item corresponding to the particular mode of transportation that will be used to transport the item.
- 147 FUNCTIONAL ANALYSIS 65 X - -
- A statement shall give, in technical and quantitative terms, a precise description of the function requiring support, including, the specific operating critical and fundamental performance characteristics, corresponding tolerance or accuracy, and design criteria necessary. Also describe the required interval for performance of the function; required input and output characteristics and measurements; and, environmental conditions under which the piece of SE is to be used.
- 148 GENERIC CODE 5 X L -
- Identifies the support/test equipment by functional group (i.e., Oscilloscope, Multimeter) (see DOD-STD-2121).
- 149 GOVERNMENT DESIGNATOR 20 X L -
- The government-type designator, as obtained from MIL-STD-196, MIL-STD-875(ASG), and MIL-N-18307(ASG).
- ATE GOVERNMENT DESIGNATOR. The government designator of the ATE.
- 150 GOVERNMENT REQUIRED 1 A F -
- Entry specifying whether or not the corresponding requirements are imposed by the government. Enter a "Y" for yes, "N" for no.
- 151 HARDNESS CRITICAL ITEM (HCI) 1 A F -
- A code which identifies an item at any assembly level which is mission critical and could be designed, repaired, manufactured, installed or maintained for normal operation and yet degrade system survivability in a nuclear, biological, or chemical hostile environment, if hardness were not considered.
- | | |
|-----------------------|---|
| Hardness critical | Y |
| Not Hardness critical | N |
- 152 HARDNESS CRITICAL PROCESS (HCP) 1 A F -
- A single-position code indicating whether or not the particular maintenance task under analysis has a bearing on an item which is mission critical. Nuclear HCPs are procedures, finishes, specifications, manufacturing techniques/procedures which are hardness critical and, if changed, could degrade nuclear hardness. Code "S" should be used if unsure whether or not a task is hardness critical at that point in time.

MIL-STD-1388-2B
APPENDIX E

	Hardness critical		Y
	Hardness critical surveillance		S
	Not hardness critical		N
153	HARDWARE DEVELOPMENT PRICE	8 N R -	
	The estimated cost in dollars of hardware development of the SE. This price does not include the cost of deliverable hardware.		
154	HAZARDOUS CODE	1 A F -	
	A code which indicates whether the item is regulated or nonregulated. For regulated items, see Code of Federal Regulations (CFR) 49 and the United Nations Transport of Hazardous Goods. Hazardous Code is required by MIL-STD-2073-1.		
	Regulated hazardous in accordance with CFR 49		D
	Nonhazardous item		N
155	HAZARDOUS MAINTENANCE PROCEDURES CODE	1 A F -	
	A code which denotes whether the performance of the maintenance action identified by the task code will potentially expose assigned maintenance personnel to hazardous conditions.		
	Potential loss of life consequences resulting from the incorrect or improper performance of maintenance.		A
	Potential severe injury resulting from the incorrect or improper performance of maintenance.		B
	Potential minor injury resulting from the incorrect or improper performance of maintenance.		C
	No potential danger to maintenance personnel conducting maintenance.		D
156	HAZARDOUS MATERIALS STORAGE COST	8 N R -	
	The projected annual cost in dollars to store hazardous material required for one end item. This figure reflects an annual storage cost averaged over an item's expected useful life.		
157	HAZARDOUS WASTE DISPOSAL COST	8 N R -	
	The projected annual cost in dollars to dispose of the hazardous waste generated due to operating/supporting one end item. This figure reflects annual disposal costs averaged over an item's expected useful life.		

MIL-STD-1388-2B
APPENDIX E

- 158 HAZARDOUS WASTE STORAGE COST 8 N R -
- The projected annual cost in dollars to store hazardous waste generated due to operating/supporting one end item. This figure reflects an annual storage cost averaged over an item's expected useful life.
- 159 HELICOPTER MISSION REQUIREMENTS 19 X - -
- Mission requirements is divided into five subfields indicating the worst (e.g., highest, coldest, longest, and heaviest) mission scenario.
- a. Altitude. The highest altitude in feet above sea level. 5 N R -
- b. Temperature. The coldest temperature in degrees Fahrenheit. 3 N R -
- c. Distance. The longest distance in nautical miles. 3 N R -
- d. Time. The longest time in hours 3 N R 1
- e. Payload. The heaviest payload in pounds. 5 N R -
- 160 HOLDING COST PERCENTAGE 2 N R -
- A percentage of inventory value to account for storage, loss, obsolescence, and interest cost incurred as a result of maintaining inventory.
- 161 HOURLY LABOR RATE PER SSC 4 N R 2
- The basic hourly rate expressed in dollars and cents for a repairman with a specific SSC.
- 162 INDENTURE CODE 1 X F -
- A code which illustrates a lateral and descending "family tree" relationship of each line item to and within the system or end item and its discrete components (units), assemblies and subassemblies, and subsubassemblies beginning with "A" for the system, "B" for the system components, "C" for assemblies, "D" for subassemblies, etc.
- a. Attaching Part/Hardware. Attaching part hardware shall be listed according to the following options as specified by the requiring authority.
- Option 1. Indentured with a "Z" below the item it attaches.
- Option 2. Indentured with a "Z" and listed as a bulk item within each appropriate level component where it appears.

MIL-STD-1388-2B
APPENDIX E

Option 3. Indentured with a "Z" and listed as a bulk item at the end of the provisioning list.

Option 4. All parts indicated on drawing will be listed in the breakdown in proper indenture without specific identification that the parts are utilized as "attaching parts".

Option 5. Attaching hardware need not be listed.

b. Indenture for kits. Whether or not kits will be included in the provisioning parts list (PPL) will be indicated on the LSAR Data Requirements Form (DD Form 1949-3). When maintenance plans/practices require that a group of parts be replaced in one maintenance or overhaul operation, these items shall be listed as a kit IAW with one of the following options:

Option 1. Kits shall be assigned an indenture lower than the subassembly/assembly/component/end item for which it is used and parts of the kit shall be identified by entering an asterisk.

Option 2. The kit reference number shall be listed at the end of the subassembly/assembly/component/end item breakdown.

Option 3. All kit parts shall be listed in the PPL in proper indenture without specific identification that the parts are kit components. The kit part number is to be listed as the last item of the applicable next higher assembly, end item/assembly/subassembly breakdown.

163 INDUSTRIAL MATERIALS ANALYSIS OF CAPACITY 19 X L -
(IMAC)

A series of codes, per MIL-STD-295, applied to identify and track selected forms and parts which are critical due to material content or other industrial planning impacts. The IMAC Code contains three sub-fields, i.e., item category (form, mechanical part, electrical part, etc.), item characteristics, and the strategic/critical materials contained in the item.

a. IMAC Category 1 A F -

b. IMAC Characteristics 12 X L -

c. IMAC Materials 6 X L -

164 INHERENT AVAILABILITY (A_i) 8 N R 6

The probability that, when used under stated conditions in an ideal support environment without consideration for preventive action, a system will operate satisfactorily at any time. The "ideal support environment" referred to, exists when the stipulated tools, parts, skilled manpower, manuals, SE and other support items required are available. A_i excludes whatever ready time, preventive maintenance downtime, supply downtime, and administrative downtime may require. A_i may be expressed by the following formula:

MIL-STD-1388-2B
APPENDIX E

$$A_i = \frac{MTBF}{MTBF+MTTR}$$

where MTBF = Mean Time Between Failures, DED 229
MTTR = Mean Time To Repair, DED 236

NOTE: The measurement bases for MTBF and MTTR must be consistent when calculating A_i .

REQUIRED INHERENT AVAILABILITY. An A_i representing the requirement/specification A_i .

165 INHERENT MAINTENANCE FACTOR 2 N R 1

A factor derived from historical information, that identifies the percent of No Defect maintenance actions that have been included in the MTBM Inherent parameter. This factor is used to relate the MTBM Inherent parameter to the MTBF parameter. The IMF may be calculated using the following formula:

$$IMF = ((MTBF-MTBM \text{ INHERENT})/MTBF)100$$

where:

MTBF = Mean Time Between Failures, DED 229

MTBM Inherent = Mean Time Between Maintenance Inherent, DED 232

166 INITIAL BIN COST 4 N R -

The initial cost in, whole dollars, of entering an item into the retail supply system. This includes the administrative cost of setting up a bin for the item at the wholesale supply point.

167 INITIAL CATALOGING COST 4 N R -

The initial cost of in, whole dollars, of entering a new item into the wholesale supply system. This is generally considered to be the cost of screening the item and assigning an NSN.

168 INPUT POWER SOURCE 25 X - AS

The operating power requirements necessary for the TMDE to function and operate properly. Consists of the following subfields.

a. Operating Range, 6 N - -

The voltage range which the Test Measurement and Diagnostic Equipment (TMDE) requires to function properly. Subfields are:

(1) Minimum 3 N R -

The minimum voltage which the TMDE requires to function properly.

(2) Maximum 3 N R -

MIL-STD-1388-2B
APPENDIX E

The maximum voltage which the TMDE requires to function properly.

b. Alternating Current/ Direct Current 1 A F -

A code indicating the type of voltage required to operate the Automatic Test Equipment/Test Measurement and Diagnostic Equipment, support/test equipment.

Alternating Current A
Direct Current D

c. Frequency Range 6 N - -

The number of periods or cycles, in hertz, for a given voltage or voltage range. Consists of following subfields:

(1) Minimum 3 N R -

The minimum frequency which the TMDE requires to function properly.

(2) Maximum 3 N R -

The maximum frequency which the TMDE requires to function properly.

d. Phase 1 N F -

The number of simultaneously applied AC voltage sources for a given voltage range.

Single phase 1
Double phase 2
Triple phase 3

e. Watts 5 N R -

The unit of power equivalent to the current of one ampere flowing across a potential difference of one volt.

f. Percent Maximum Ripple 4 N R 2

The percent maximum ripple allowable of the output voltage of the power source available to operate the TMDE.

g. Source Option Number 2 N R -

A number sequentially assigned from 1 to 99 that is used to distinguish between different sets of values of input power requirements for a specific piece of support equipment.

169 INSTALLATION FACTORS OR OTHER FACILITIES 65 X - -

MIL-STD-1388-2B
APPENDIX E

A narrative description identifying any considerations required for the installation of support and test equipment, or training material, such as vibration and shock mounting requirements, special foundations, utilities connections, and environmental factors. Also, includes any equipment necessary to install the item, e.g., cranes, hoists, lift trucks, transits, etc. When new or modified facilities are required to house the support, test equipment, or training materials, facilities data table(s) may also be required.

170 INTEGRATED LOGISTIC SUPPORT PRICE 8 N R -

The total cost associated with ILS deliverable recommendations made by the contractor.

171 INTEGRATED LOGISTIC SUPPORT REQUIREMENTS 1 A F -
CATEGORY CODE

A code indicating the ILS requirements. Codes are as follows:

Integrated logistic support plan	A
Logistic support analysis	B
Maintenance plan	C
Support materials list	D
Repair of repairables	E
Provisioning technical documentation	F
Master index of repairables	G
Calibration and Measurement Requirements Summary	H
Facilities data	I
Technical manuals	J
Maintenance requirements card	K
Instrument calibration procedures	L
Phased support plan	M
Component pilot rework/repair	N
Rework standard	O
New start	P
Training	Q
Contractor engineering and technical services	R
Packaging, handling, storage and transportation	S
Other	T
Estimated total ILS price	U

172 INTERCHANGEABILITY CODE 2 A F -

A code which indicates relationship of items.

a. Signifies one-way (OW) interchangeability as follows:

(1) When used for a change to the original item, means that the original item may be used until exhausted. OW

MIL-STD-1388-2B
APPENDIX E

- (2) When used for the replacement item, "OR" means that the new item may be used to replace the original item. OR
- b. Signifies that the original item and replacement item are interchangeable with each other. TW
- c. Signifies that the item is not interchangeable (NI) as follows:
- (1) When used for the original item, NI means that the item is not interchangeable with the replacement item. NI
- (2) When used for the replacement item, NR means that the replacement item is not interchangeable with the original item. NR
- d. Signifies that the original item is interchangeable with the replacement item only if modified to the replacement item configuration and only in the new application. OM
- e. Signifies that the original item is interchangeable in both the old and new application only if the original item is modified to the replacement configuration. TM

SUPERCEDURE INTERCHANGEABILITY CODE. An interchangeability code used to identify whether the SE replacing or being replaced by the SE under analysis is interchangeable with it.

173 INTEREST RATE 3 N R 2

The rate of interest used to account for the time value of money when performing cost analyses and converting expenditures over a period of time to a common point.

174 INTERMEDIATE CONTAINER CODE 2 X F -

A code to identify a container which holds two or more unit packs of identical items. For applicable codes, see MIL-STD-2073-1 and MIL-STD-2073-2.

175 INTERMEDIATE CONTAINER QUANTITY 3 A F -
3 N R -

The quantity of unit packs contained in the Intermediate Container. For quantities over 999, see MIL-STD-2073-1 and MIL-STD-2073-2.

176 INVENTORY STORAGE SPACE COST 4 N R 2

The cost of storing repairable item inventory at the designated maintenance facility. This cost is in dollars per cubic foot per month.

MIL-STD-1388-2B
APPENDIX E

177 ITEM CATEGORY CODE (ICC)

2 X L -

A code which identifies a type of item and indicates categories into which support and test equipment, spares, repairs parts, etc. may be divided.

Note: ICCs of "A", "B", and "C" should not be assigned to hardware items since these codes are reserved for grouping and selecting similar ICCs, during ADP processing.

Peculiar SE and tools not currently in the DOD inventory (ICC Group A):

Peculiar SE (Other)	7
Peculiar tools	8
Peculiar test equipment	M
Peculiar handling equipment	D
Peculiar automatic test equipment (ATE)	1

Common SE and tools currently in the DOD inventory (ICC Group B):

Common SE (Other)	H
Common tools	4
Common test equipment	5
Common handling equipment	6
Common ATE	2

Common SE and tools currently in the DOD inventory but not assigned to a unit/ship (ICC Group C):

Common SE (Other)	G
Common tools	N
Common test equipment	P
Common handling equipment	R
Common ATE	3

Bulk items	Q
Training material not currently in the DOD inventory	S
Training material currently in the DOD inventory	T
End item	W
Spare (repairable support item)	X
Repair part (a nonrepairable consumable support item, component, assembly)	Y
Repair parts kit	Z
A repair part, component or assembly contained in a kit/set.	9
Tool kit/set	V
Program (embedded software)	E
Tech manuals	F
Forms or records	J
Electrostatic discharge sensitive item	K

MIL-STD-1388-2B
APPENDIX E

Electromagnetic sensitive item	L
Facilities	U
System peculiar spare part	AA
Maintenance significant consumable	AB
Modified hand tool	AC
Maintenance assist module	AD
Attaching hardware	AE
Training Equipment	AF

178 ITEM CRITICALITY NUMBER (C_r) 10 D - -

The sum of the Failure Mode Criticality Numbers related to the failure modes of an item within specific severity classifications and mission phases. The following formula may be used to calculate Item C_r :

$$C_r = \sum_{n=1}^j (C_m)_n \quad n = 1, 2, 3 \dots j$$

where

C_r = Criticality number for the item

C_m = Failure mode criticality number, DED 133

n = The failure modes in the items that fall under a particular severity classification/mission phase combination

j = Last failure mode in the item under the severity classification/mission phase combination

179 ITEM DESIGNATOR CODE 26 X - -

A part of nomenclature which provides a method for identifying equipment, usually by broad performance and use characteristics and general configuration. It is a data chain consisting of all or part of the data elements type, model, and series designators, in that order. A suffix may be added for use with the Joint Electronics Type Designation System. Instructions for coding the type, model, and series designators are contained in MIL-STD-482, appendix II, CM51 and consists of the following subfields:

a. Type designator 7 X L -

A broad categorization of equipment based upon function or use.

b. Model designator 10 X L -

Identifies equipment within a particular type designator having essentially the same performance characteristics.

c. Series designator 2 X L -

Identifies equipment within a particular model designator having the same basic design, but not necessarily the same configuration.

d. Suffix designator 7 X L -

MIL-STD-1388-2B
APPENDIX E

Supplemental information used with type, model, series designators for items using the Joint Electronics Type Designation Systems. Instructions for coding suffix designator can be found in the following publications:

MIL-STD-155	Joint Photographic Type Designation System
MIL-STD-196	Joint Electronics Type Designations System
MIL-STD-815	Designation System for Liquid, Solid and Liquid-solid (Hybrid) Propellant Rocket Engines and Motor
MIL-STD-875	Type Designation System for Aeronautical and Support Equipment
MIL-STD-879	Designation for Aircraft Propulsion Gas Turbine Engines
AR 700-26 NAVAIRINST 13100.3 AFR 66-11	Designating and Naming Military Aircraft
AR 70-50 NAVMATINST 8800.4 AFR 82-5	Designating and Naming Defense Equipment, Rockets, and Guided Missiles
ANA Bulletin 306	Engines, Aircraft Reciprocating, Designation of
ANA Bulletin 395	Naval Ordnance Requirements, Mark and Mod Nomenclature System

END ARTICLE ITEM DESIGNATOR. The item designator code of the end article used in the 070 Report.

SYSTEM EQUIPMENT ITEM DESIGNATOR. The item designator code of the system equipment item.

SYSTEM/EI ITEM DESIGNATOR CODE. The item designator code of the system/ end item.

180 ITEM FUNCTION

65 X - -

A narrative description identifying the function, specifications, and tolerances of the item under analysis (e.g., supply 10 gallons per minute of hydraulic fluid at 3,000 psi for normal activation of pilot's canopy, hose, main landing gear extension, wheel brakes, and flap extension).

181 ITEM MANAGEMENT CODE (IMC)

1 A F -

A single character indicating whether an item of supply shall be subject to integrated management or shall be retained by the individual military

MIL-STD-1388-2B
APPENDIX E

services or other DOD components. The IMC is applicable to all NSN items in those commodity areas assigned for integrated material management. Definitions of IMC are contained in DOD-4100.38-M.

182 ITEM NAME 19 X L -

An identifying noun with appropriate adjective modifier, as contained in Federal Item Name Directory for Supply Cataloging, H6-1. Item Names contained in Federal Item Name Directory for Supply Cataloging, H6-1, cannot be abbreviated unless approved by the requiring authority. When abbreviation is approved by the requiring authority, the nonapproved item names can be abbreviated IAW MIL-STD-12.

INTEROPERABLE ITEM NAME. The name of the item that the end item under analysis is expected to interoperate with.

SUPERCEDEURE ITEM NAME. An item name of the SE being superceded by or superceding the support equipment under analysis.

183 ITEM NAME CODE 5 N F -

A number which serves as a cross-reference to each approved item name as contained in the Federal Item Name Directory for Supply Cataloging, H6-1. Names and noun concepts other than approved item names or noun concepts are assigned Item Name Code "77777".

184 ITEM NUMBER 4 X R -

An index number assigned to an item for a specific illustration.

185 JOB 40 X L -

The combination of all human performance required for operation and maintenance of one personnel position in a system (e.g. driver).

186 JOB CODE 2 X F -

An assigned code which is associated with a specific job.

187 JULIAN DATE 5 N F -

The julian date consists of the last two numbers of the calendar year and the numeric day of the year, i.e., February 5, 1990, would be 90036.

188 JUSTIFICATION 65 X - -

A narrative description identifying major factors which: (a) led to the decision that additional facilities, personnel, training, training material, support and test equipment, etc., are required; or, (b) provided the basis for establishing the maintenance concept or making a major program decision.

189 LABOR RATE 4 N R 2

MIL-STD-1388-2B
APPENDIX E

The average direct labor rate per hour for an Operations/Maintenance (O/M) Level. Labor rate is in units of dollars and cents.

190 LIFE CYCLE STATUS 1 A F -

The current life cycle phase of an item of equipment. The life cycle of a hardware item, extending from "cradle to grave", is divided into four phases: exploration; acquisition; deployment/operations; and, disposal (includes storage and reclamation). The acquisition phase subdivides into the following four phases:

Concept Exploration and Definition	C
Demonstration and Validation	D
Engineering and Manufacturing Development	F
Production and Deployment	P
Operations and Support	S

191 LIFE SPAN 2 N R -

The estimated useful life, in years, of the support/test equipment.

192 LIFTING AND TIEDOWN REQUIREMENT FOR TRANSPORTATION 65 X L -

Narrative information of the number, location by dimensions, and strength (rated, yield, and ultimate) of lifting and tiedown provisions for the item and major components removed for transport. Identified are the locations of hardpoint lifting provisions provided for aerial recovery. State if the lifting provisions meet criteria of MIL-STD-209 and interface with all aerial recovery and sling component.

193 LINE ITEM NUMBER (LIN) 6 X L -

A unique number assigned by the requiring authority to all items of equipment for which a specific service has proponency (see SB 700-20).

194 LINE REPLACEABLE UNIT (LRU) 1 A F -

An LRU is an essential support item which is removed and replaced at field level to restore the end item to an operationally ready condition. Conversely, a non-LRU is a part, component, or assembly used in the repair of an LRU, when the LRU has failed and has been removed from the end item for repair.

Item is an LRU	Y
Item is not an LRU	N

195 LOADING FACTOR 3 N R 2

A factor which is applied to the hourly and annual manpower costs to account for overhead, benefits, permanent change of station moves, hazardous duty, etc.

196 LOGISTIC CONSIDERATIONS 13 A - -

MIL-STD-1388-2B
APPENDIX E

A checklist consisting of 13 individual logistics factors impacting upon the attainment of specified maintainability goals for the item under analysis. An entry of Y, N, or Z is entered against each factor as depicted below.

Yes	Y
No	N
Not applicable	Z

The individual factors that constitute the subfields are:

Standardization. A logistic consideration indicating whether the design of the item under analysis meet the DOD policy to adapt, when possible, to:
(a) common or compatible operational, administrative and logistic procedures;
(b) common or compatible technical procedures and criteria; (c) common, compatible, or interchangeable supplies, components, weapons, or equipment; and, (d) common or compatible tactical doctrine with corresponding organizational compatibility (JCS PUB 1).

Accessibility. A logistic consideration indicating whether admission to the various areas of the item under analysis can be achieved with relative ease.

Maintenance Ease. A logistic consideration indicating whether required maintenance can be performed without physical difficulty.

Safety. A logistic consideration indicating whether adequate design provisions have been made to ensure the conservation of human life and effectiveness, and the prevention of damage to items, consistent with mission requirements.

Test Points. A logistic consideration indicating whether adequate design considerations have been made for test points on the item under analysis.

Skills. A logistic consideration indicating whether existing skills are available and sufficient to perform required maintenance on the item under analysis.

Training. A logistic consideration indicating whether adequate training programs have been planned for the performance of O/M tasks on the item under analysis.

Connectors for Ease of Removal. A logistic consideration indicating whether the item design includes the use of connectors to facilitate removal.

Packaging and Transportation. A logistic consideration indicating whether the packaging material and transportation mediums, designed for the item under analysis, will adequately protect it during transport.

Fault Location. A logistic consideration indicating whether adequate design provisions have been made to facilitate the location of the causes of failures or malfunctions of the item under analysis.

MIL-STD-1388-2B
APPENDIX E

Labeling. A logistic consideration indicating whether adequate parts associated with maintenance are identified and visible with respect to circuit symbol or part identification.

Design for Self Protection Against Damage After Failure. A logistic consideration indicating whether provisions have been made to restrict the progress of deterioration after failure of the item under analysis.

Corrosion/Rust Control. A logistic consideration indicating whether adequate corrective or preventive actions have been developed to deter corrosion or rust damage to the item under analysis.

197 LOGISTIC CONTROL CODE 1 A F -

A single-position code assigned to adopted items and other items of material selected for authorization to provide a basis for logistical support decisions; i.e., procurement, overhaul, repair parts provisioning, requisitioning, and distributing.

Standard A	A
Standard B	B
Item previously type-classified under earlier regulations and is still in the inventory (item has not yet been reclassified)	C
Developmental	D
Contingency and training-contingency	F
Not separately type-classified	N
Obsolete	O
Items exempt from Army type classification	R
Contingency and training	S
Limited production-test	T
Limited production-urgent	U

198 LOGISTICS DECISION OFFICE 15 X L -

Identifies the activity name and code or office symbol responsible for logistics management decisions, or the system program manager/end article item manager.

199 LOGISTIC SUPPORT ANALYSIS CONTROL NUMBER (LCN) 18 X L -

A code that represents a functional or hardware generation breakdown/disassembly sequence of system/equipment hardware including SE, training equipment, and installation (connecting) hardware. For additional information on assignment of LCN, refer to appendix C.

ANNUAL OPERATING REQUIREMENT LCN. An LCN migrated from table AG that is required to identify the AORs measurement base.

FAILURE MODE TASK LCN. An LCN representing the failure mode against which a corrective or preventive task is documented.

MIL-STD-1388-2B
APPENDIX E

FUNCTIONAL LSA CONTROL NUMBER. An LCN representing the functional system/equipment breakdown.

PHYSICAL LSA CONTROL NUMBER. An LCN representing the hardware breakdown of the system/equipment.

REFERENCED LCN. An LCN that contains referenced task information.

REFERENCED SUBTASK LCN. An LCN that contains referenced subtask information.

S/N ITEM LSA CONTROL NUMBER. An LCN representing the item under analysis having a serial number relationship.

S/N PROVISIONING LSA CONTROL NUMBER. An LCN representing the provisioned item under analysis having a serial number relationship.

S/N PROVISIONING SYSTEM/EI LCN. An LCN representing the provisioned system/end item having a serial number relationship.

S/N SYSTEM/END ITEM LCN. An LCN representing the system/end item having a serial number relationship.

TASK LSA CONTROL NUMBER. An LCN of the item under task analysis.

TASK PROVISION LCN. An LCN of the item which is to be provisioned, based on the task analysis of the task LCN.

TASK REQUIREMENT LCN. An LCN of the item under task analysis.

UOC ITEM LSA CONTROL NUMBER. An LCN representing the item under analysis having a UOC relationship.

UOC PROVISIONING LSA CONTROL NUMBER. An LCN representing the provisioned item under analysis having a UOC relationship.

UOC PROVISIONING SYSTEM/EI LCN. An LCN representing the provisioned system/end item having a UOC relationship.

UOC SYSTEM/EI LCN. An LCN representing the system/end item having a UOC relationship.

UUT LSA CONTROL NUMBER. An LCN of the Unit Under Test.

200 LOGISTIC SUPPORT ANALYSIS CONTROL NUMBER - INDENTURE CODE (LCN-IC) 1 A F -

A single-position code which reflects the relationship of the item to the total LSAR system. The LCN-IC depicts an item's relationship based upon the assigned LCN, not to a subordinate, provisioned end item.

201 LOGISTIC SUPPORT ANALYSIS CONTROL NUMBER (LCN) NOMENCLATURE 19 X L -

MIL-STD-1388-2B
APPENDIX E

An identifying noun with an appropriate adjective modifier identifying the LCN item. When using the modified classical LCN assignment method, then "REPAIR PARTS" is used to identify an LCN representing more than one reference number and CAGE combination.

202 LOGISTIC SUPPORT ANALYSIS CONTROL 18 N L -
NUMBER STRUCTURE (LCN STRUCTURE)

A number signifying the number of indenture levels represented by the LCN when the LCNs are assigned using the classical or modified classical assignment method. The first digit of the LCN structure is the number of digits used in the LCN to identify the first indenture level. The second digit is the number of digits used to identify the second indenture level, etc.

203 LOGISTIC SUPPORT ANALYSIS CONTROL 1 A F -
NUMBER TYPE (LCN-TYPE)

A code indicating whether the LCN is representative of either a physical or functional breakdown.

Physical	P
Functional	F

AOR LCN TYPE. An LCN-TYPE against the AORs.

FMT LCN TYPE. An LCN-TYPE representing the failure mode against which either a corrective or preventive task is documented.

FUNCTIONAL LCN TYPE. An LCN-TYPE representing the functional system/equipment breakdown.

PHYSICAL LCN TYPE. An LCN-TYPE representing the hardware breakdown of the system/equipment.

REFERENCED LCN TYPE. An LCN-TYPE that contains referenced task information.

REFERENCED SUBTASK LCN TYPE. An LCN-TYPE that contains referenced subtask information.

S/N ITEM LCN TYPE. An LCN-TYPE representing the item under analysis having a serial number relationship.

S/N SYSTEM/EI LCN-TYPE. An LCN-TYPE representing the system/end item having a serial number relationship.

TASK LCN TYPE. An LCN-TYPE of the item under task analysis.

TASK PROVISION LCN TYPE. An LCN-TYPE of the item which is to be provisioned, based on the task analysis.

TASK REQUIREMENT LCN TYPE. An LCN-TYPE of the item under task analysis.

MIL-STD-1388-2B
APPENDIX E

UOC ITEM LCN TYPE. An LCN-TYPE representing the item under analysis having a UOC relationship.

UOC SYSTEM/EI LCN TYPE. An LCN-TYPE representing the system/end item having a UOC relationship.

UUT LCN TYPE. An LCN-TYPE of the Unit Under Test.

204 LOGISTIC SUPPORT ANALYSIS RECOMMENDATION CODE 1 A F -

A single-position code that indicates whether the support/test equipment is recommended as an LSA candidate.

Recommended	Y
Not recommended	N

205 LOT QUANTITY 12 N - -

A two-part sequence identifying the purchase/production lot quantity ranges to which the UM or UI price apply. The field is divided into two subfields for beginning and ending lot size.

a. From 6 N R -

The beginning Lot Quantity of the item to which the UM/UI PRICE applies.

UI PRICE LOT QUANTITY FROM. The UI price beginning lot quantity.

UM PRICE LOT QUANTITY FROM. The UM price beginning lot quantity.

b. To 6 N R -

The ending Lot Quantity of the item to which the UM/UI PRICE applies.

UI PRICE LOT QUANTITY TO. The UI price ending lot quantity.

UM PRICE LOT QUANTITY TO. The UM price ending lot quantity.

206 MAINTENANCE ACTION CODE (MAC) 1 A F -

A code which indicates the required action to be taken at the expiration of the Maximum Allowable Operating Time (MAOT).

Calibrate	B
Condemn	C
Scheduled maintenance (as specified in the technical manual of planned maintenance system (PMS) and not covered by another MAC)	S
Repair	R
Test and Repair	T

207 MAINTENANCE CONCEPT 65 X - -

MIL-STD-1388-2B
APPENDIX E

A narrative description identifying the broad, planned approach to be employed in sustaining the system/equipment at a defined level of readiness, or in a specified condition in support of the operational requirement. Initially stated by the requiring authority for design and support planning purposes and is expanded by performing activity prepared inputs during full-scale development. Provides the basis for the maintenance plan. Usually includes guidelines pertaining to projected maintenance tasks, levels, and locations: organic/contractor maintenance work load mix; condition monitoring, fault isolation and testing approach; and, compatibility with existing support and test equipment, etc. May be influenced or modified as system/equipment development proceeds.

208 MAINTENANCE INTERVAL 10 D - -

The number of operational units (e.g. rounds, miles, hours) between preventive maintenance derived as an outcome of RCM analysis.

209 MAINTENANCE PLAN NUMBER 23 X L -

A number assigned by the government to identify an approved maintenance plan.

210 MAINTENANCE PLAN RATIONALE 65 X - -

A narrative description of support data and analysis used in preparation of the maintenance plan. The impact of LSA including FMECA; RCM; and, level of repair analysis should be documented. In addition, the use of data from like and similar equipment and lessons learned in formation should also be identified.

211 MAINTENANCE REPLACEMENT RATE I (MRRI) 8 N R 4

The MRRI is defined as the peacetime replacement rate factor for the item indicating the number of expected failures, which will require removal and replacement of the support item below depot level in a given next higher assembly per equipment/end item per year. This factor is to be based on the known/estimated end item usage and mature failure rates.

The MRRI can be calculated using the following formula:

For an assembly:

$$\text{MRR (assembly)} = \sum_{i=1}^N \text{TF}_i \times \text{Quantity per task}_i$$

Where:

N = Number of H function tasks for a given LCN/ALC combination (except D O/M levels)

TF_i = Task frequency

For a repair part:

MIL-STD-1388-2B
APPENDIX E

$$\text{MRR (repair part)} = \sum_{i=1}^N \text{TF}_i \times \text{Quantity per task}_i$$

Where:

N = Number of J function tasks performed against the next higher assembly of the repair part

TF_i = Task frequency

212 MAINTENANCE REPLACEMENT RATE II 8 N R 3
(MRRII)

The MRRII can be defined by each of the following options:

Option 1. The MRRII is the replacement rate of the item calculated as follows:

$$\text{MRRII} = \text{MRR I} \times \frac{\text{annual operating program wartime}}{\text{annual operating program peacetime}}$$

When this computation results in zero, use the following definition:

The MRRII is the replacement rate of the line item per wartime operating program. The wartime operating program will be provided by the requiring authority. The MRRII will consider secondary failures, idleness, operator error, preventive/planned maintenance, handling and storage.

Option 2. The MRRII is the wartime replacement rate for the item indicating the number of expected failures, which will require removal and replacement of the support item below depot level in a given next higher assembly per equipment/end item per year. This factor is to be based on the known/estimated end item usage and will include consideration of intensified rate of usage; increased stress due to combat operations; accident rate; ballistic damages; and, differences in turnaround time.

213 MAINTENANCE REPLACEMENT RATE MODIFIER 7 X F -
(MRR MOD)

A series of codes used to modify (multiply) the MRR for environmental conditions by area of system/equipment deployment. Consists of seven subfields. The first six subfields identify the multiplier to use for the following geographic areas: CONUS (C); Europe (E); Pacific (P); Southern Command (S); Mideast (M); and, Alaska (A), respectively.

<u>Multiplier</u>	<u>Code</u>
0.25	A
0.50	B
0.75	C
1.00	1
1.25	2
1.50	3
1.75	4

MIL-STD-1388-2B
APPENDIX E

2.00	5
2.25	6
2.50	7
2.75	8
3.00	9
No requirement	0

The seventh subfield is a code to indicate if the item is subject to a wearout failure pattern, in which case it is coded "W".

214 MAINTENANCE TASK DISTRIBUTION 14 N - -

The percentage of a repairable item expected to be repaired and returned to stock by a specified maintenance level. The field is divided into subfields by maintenance level (for definitions of the Operations/Maintenance levels, see DED 277).

a. Maintenance Task Distribution at Organizational/On Equipment/Unit-Organizational 2 N R

b. Maintenance Task Distribution at Intermediate/Direct Support/Afloat/Third Echelon/Off Equipment/Intermediate-Forward 2 N R -

c. Maintenance Task Distribution at Intermediate/General Support/Ashore/Fourth Echelon/Intermediate-Rear 2 N R -

d. Maintenance Task Distribution at Specialized Repair Activity 2 N R -

e. Maintenance Task Distribution at Depot/Shipyards 2 N R -

f. Maintenance/Task Distribution at Condemnation Below Depot 2 N R -

g. Maintenance Task Distribution at Condemnation At Depot 2 N R -

215 MAN-HOUR PER OPERATING HOUR 16 N - -

The ratio of maintenance man-hours expended to the operating interval (as defined by the measurement base) of the system/equipment. The item contains two components:

a. Scheduled 8 N R 5

Total maintenance man-hours expended for preventive maintenance divided by the total operating hours.

b. Unscheduled 8 N R 5

Total maintenance man-hours expended for corrective maintenance divided by the total operating hours.

MIL-STD-1388-2B
APPENDIX E

216	MANAGEMENT PLAN	1 A F -
	A code entered by the government that directs contractor action on a general management/milestone plan.	
	Milestone plan to be developed IAW the CDRL	Y
	Milestone plan not required	N
217	MANAGING COMMAND/AGENCY	10 X L -
	The name or official abbreviation, as contained in JCS Publication 1 of the DOD agency, Federal Agency, or major command which has the integrated commodity management of the support/test equipment or training material, e.g., MICOM, TACOM, NAVAIR, NAVELEX, AFLC, SAALC.	
218	MATERIAL	240 X L -
	A narrative description identifying the chemical compound or mechanical mixture properties of which the item is fabricated.	
219	MATERIAL LEADTIME	3 N R -
	The order and ship time, in weeks, for critical/strategic materials used in manufacture of the item. This data is required for items assigned an IMAC code (DED 163).	
220	MATERIAL WEIGHT	6 N R 3
	The amount, in pounds, of critical/strategic material contained in an item. This data is required for items assigned an IMAC code (DED 163).	
221	MAXIMUM ALLOWABLE OPERATING TIME (MAOT)	4 X - -
	The expressed period of time after which certain items will be maintained in accordance with the Maintenance Action Code. The MAOT is composed of the following:	
	a. <u>First two-positions.</u> Number of applicable program units; i.e., 01-99.	
	b. <u>Third-position.</u> Appropriate multiplier code.	
	1 X program units	Blank
	10 X program units	X
	100 X program units	C
	1000 X program units	M
	c. <u>Fourth-Position.</u> Code to designate the program units.	
	Arrestments	A
	Launches	C
	Hours	H
	Miles	M

MIL-STD-1388-2B
APPENDIX E

Rounds	R
Starts	S
Landings	L
Days	D
Months (for provisioning purposes only)	T
Steaming/underway hours	U
Years	Y

222 MAXIMUM TIME TO REPAIR 5 N R 2
(MAXTTR)

The maximum corrective maintenance downtime within which a specified percent (normally 90 or 95 percent) of all corrective maintenance actions can be accomplished.

MAINTENANCE LEVEL MAXIMUM TIME TO REPAIR. An MAXTTR for a specified O/M level.

REQUIRED MAXIMUM TIME TO REPAIR. An MAXTTR specified as a supportability requirement/specification.

223 MEAN ACTIVE MAINTENANCE DOWNTIME 6 N R 1
(MAMDT)

The statistical mean of the individual elapsed times for all maintenance tasks during a specified period of time (clock hours). The MAMDT, or M, is the weighted average of the mean time to repair (MTTR), and mean preventive maintenance action time (MTPM). When the number of corrective maintenance actions, (NC) and the number of preventive maintenance actions (NP) have been determined for a common reference time, the following formula may be used to calculate MAMDT:

$$M = \text{MAMDT} = \frac{(\text{MTTR} \times \text{NC}) + (\text{MTPM} \times \text{NP})}{\text{NC} + \text{NP}}$$

MAMDT is documented as both technical and operational characteristics. Technical parameters reflect the technical reliability that the system/equipment must demonstrate. In determining these parameter values, all failures and resultant actions to restore the item (e.g., a broken tail light is a technical, but not operational characteristic). Operational parameters reflect operational reliability and maintainability characteristics that the system must demonstrate. Only operational mission failures and the resultant tasks are included (e.g., engine failure will result in mission abort which is both an operational and technical failure).

224 MEAN ELAPSED TIME 5 N R 2

The average time expended, regardless of the number of personnel working simultaneously, required to perform a task. This does not include logistics delay time. The time can be predicted or measured, or can be specified as requirements as depicted below:

MIL-STD-1388-2B
APPENDIX E

a. Predicted - The estimated time required in the performance of a task expressed in hours and hundredths.

b. Measured - The actual clock time recorded in the completion of a task from start to finish, expressed in hours and hundredths. Measured mean elapsed times are calculated by summing mean minute elapsed times for all subtasks. The following formula is used to calculate measured mean elapsed time:

$$\text{Measured Mean Elapsed Time} = \frac{\sum_{i=1}^N \text{MMET}_i}{60}$$

Where: N = Total number of subtasks per task
MMET_i = Mean minute elapsed time

c. Required. The maximum time allowed to accomplish a task.

225 MEAN MAN-HOURS 5 N R 2

The average number of man-hours required to perform a unit of work. The man-hours can be predicted or measured as defined below, or can be specified as requirements as depicted below:

a. Predicted - The estimated time required in the performance of a task expressed in hours and hundredths.

b. Measured - The actual total clock time recorded in the performance of a task expressed in hours and hundredths. Measured mean manhours are calculated only if mean man-minute per person identifier are entered for the given task. The following formula is used to calculate Measured Mean Man-Hours (MMM_H) for a given task:

$$\text{MMM}_H = \frac{\sum_{i=1}^N \text{MMM}_i}{60}$$

Where: N = Total number of person ID
MMM_i = Mean man-minutes

c. Required. The maximum man-hours allowed to accomplish a task.

226 MEAN MAN-MINUTES 4 N R 1

The mean man-minutes required for each person identified to perform a step within a task expressed in minutes and tenths.

227 MEAN MINUTE ELAPSED TIME 5 N R 1

MIL-STD-1388-2B
APPENDIX E

The mean minute elapsed time required for each subtask, expressed in minutes and tenths, regardless of the number of personnel working simultaneously. This does not include logistic delay time.

228 MEAN MISSION DURATION 6 N R 1

The average length of a mission for an item.

229 MEAN TIME BETWEEN FAILURES 10 D - -
(MTBF)

For a particular interval, the total functional life of a population of an item divided by the total number of failures within the population during the measurement interval. The definition holds for time, rounds, miles, events, or other measure of life units.

MTBF is documented as both technical and operational characteristics. Technical parameters reflect the technical reliability that the system/equipment must demonstrate. In determining these parameter values, all failures and resultant actions to restore the item (e.g., a broken tail light is a technical, but not operational characteristic). Operational parameters reflect operational reliability and maintainability characteristics that the system must demonstrate. Only operational mission failures and the resultant tasks are included (e.g., engine failure will result in mission abort which is both an operational and technical failure).

REQUIRED MEAN TIME BETWEEN FAILURES. An MTBF representing the supportability requirement/specification MTBF.

SUPPORT EQUIPMENT MTBF - An MTBF of the support equipment.

230 MEAN TIME BETWEEN MAINTENANCE ACTIONS 10 D - -
(MTBMA)

The mean of the distribution of the time intervals between actions or groups of actions required to restore an item to, or maintain it in, a specified condition. This entry will be composed of the MTBF, Mean Time Between Maintenance Induced (MTBM INDUCED), Mean Time Between Maintenance No Defect (MTBM NO DEFECT), and Mean Time Between Preventive Maintenance (MTBPM) values (see DED 229, DED 231, DED 233, and DED 234). MTBMA may be calculated by the following formula:

$$MTBMA = \left[\frac{1}{MTBF} + \frac{1}{MTBM \text{ INDUCED}} + \frac{1}{MTBM \text{ NO DEFECT}} + \frac{1}{MTBPM} \right]^{-1}$$

MTBMA is documented as both technical and operational characteristics. Technical parameters reflect the technical reliability that the system/equipment must demonstrate. In determining these parameter values, all failures and resultant actions to restore the item (e.g., a broken tail light is a technical, but not operational characteristic). Operational parameters reflect operational reliability and maintainability characteristics that the system must demonstrate. Only operational mission failures and the resultant tasks are included (e.g., engine failure

MIL-STD-1388-2B
APPENDIX E

will result in mission abort which is both an operational and technical failure).

REQUIRED MEAN TIME BETWEEN MAINTENANCE ACTIONS. A MTBMA representing the supportability requirement/specification MTBMA.

231 MEAN TIME BETWEEN MAINTENANCE INDUCED 10 D - -
(MTBM INDUCED)

One of four categories of maintenance events contributing to the Mean Time Between Maintenance Actions (MTBMA) value (see DED 230). Induced malfunctions are those induced in the system/equipment under analysis from external sources (i.e., other equipment, personnel, etc.).

232 MEAN TIME BETWEEN MAINTENANCE INHERENT 10 D - -
(MTBM INHERENT)

The average time (or other measurement base) between on-equipment maintenance events that are classified as inherent malfunctions, i.e., those malfunctions that are assumed to result from internal design/manufacturing defects. Engineering failure analyses are not performed to verify validity of this assumed (and reported) classification.

Note: MTBM INHERENT is not the same as MTBF. MTBM INHERENT is derived from maintenance records which are automatically processed and categorized into types of maintenance actions/events. Failures are generally only a subset of all the events that are categorized as inherent maintenance events. The relationship between MTBM INHERENT and MTBF may be calculated by the following formula:

$$\text{MTBM INHERENT} = \frac{100 - \text{IMF}}{100} \times \text{MTBF}$$

233 MEAN TIME BETWEEN MAINTENANCE NO DEFECT (MTBM NO DEFECT) 10 D - -

One of the four categories of maintenance events contributing to the Mean Time Between Maintenance Actions (MTBMA) value (see DED 230). These events consist of removals, replacements, and reinstallations of equipment due to erroneous failure indication. The MTBM NO DEFECT shall be developed by using historical data and field feedback information from similar items to establish the number of maintenance events that are the result of erroneous failure indication. An alternative procedure approved by the requiring authority may be used in lieu of the above procedure.

234 MEAN TIME BETWEEN PREVENTIVE MAINTENANCE (MTBPM) 10 D - -

The mean of the distribution of intervals, measured in hours, rounds, etc., between preventive maintenance actions. This is one of the four categories of maintenance events contributing to the Mean Time Between Maintenance Actions (MTBMA) value (see DED 230). MTBPM may be calculated by the following formula:

MIL-STD-1388-2B
APPENDIX E

$$MTBPM = \frac{AOR \times \sum_{i=1}^{N} CON FAC \times TFi}{N}$$

Where:

- i = Preventive maintenance action
- TFi = Task frequency of the "i" preventive maintenance action
- N = Total number of preventive maintenance actions charged against the LCN/ALC item under analysis
- AOR = Annual operating requirement
- CON FAC = Conversion factor for the LCN/ALC item under analysis

235 MEAN TIME BETWEEN REMOVALS (MTBR) 10 D - -

A measure of the system reliability parameter related to demand for logistics support. The total number of operational units (e.g., miles, rounds, hours) divided by the total number of items removed from that system during a stated period of time. This term is defined to exclude removals performed to facilitate other maintenance and removals for product improvement. MTBR may be calculated by the following formula:

$$MTBR = \frac{AOR \times \sum_{i=1}^{N} CON FAC \times Tfi}{N}$$

Where:

- AOR = Annual operating requirement
- CON FAC = Conversion factor for the LCN/ALC item under analysis
- Tfi = Task frequency of the "i" applicable maintenance action
- N = Total number of applicable maintenance actions
- I = Applicable maintenance action (See note below)

Note: For a particular task to be applicable, it must meet ALL of the following criteria:

- a. It must be either a "remove" or a "remove and replace" task.
- b. It must be categorized as either an "emergency" or an "un-scheduled" task.
- c. The task must be performed by "operator/crew/unit-crew" or "organizational/on equipment/unit-organizational" or by a maintenance contact team.
- d. The task can not be performed to facilitate other maintenance or for product improvement.

REQUIRED MEAN TIME BETWEEN REMOVALS. An MTBR representing the support-ability requirement/specification MTBR.

236 MEAN TIME TO REPAIR (MTTR) 5 N R 2

MIL-STD-1388-2B
APPENDIX E

The total elapsed time (clock hours) for corrective maintenance divided by the total number of corrective maintenance actions during a given period of time. MTTR may be calculated by the following formula:

$$MTTR = \frac{\sum_{i=1}^N (TF_i) \times (ET_i)}{\sum_{i=1}^N TF_i}$$

Where:

- i = On equipment corrective maintenance actions
- TF_i = Task frequency of "i" on equipment maintenance action
- N = Total number of on equipment corrective maintenance actions charged against the LCN/ALC item under analysis
- ET_i = Mean elapsed time of the "i" on equipment corrective maintenance action

MTTR is documented as both technical and operational characteristics. Technical parameters reflect the technical reliability that the system/equipment must demonstrate. In determining these parameter values, all failures and resultant actions to restore the item (e.g., a broken tail light is a technical, but not operational characteristic). Operational parameters reflect operational reliability and maintainability characteristics that the system must demonstrate. Only operational mission failures and the resultant tasks are included (e.g., engine failure will result in mission abort which is both an operational and technical failure).

REQUIRED MEAN TIME TO REPAIR. An MTTR representing the supportability requirement/specification MTTR.

237 MEANS OF DETECTION 2 A - -

The means by which a system, subsystem, assembly, or subassembly is checked to verify its operational state or condition consisting of both a primary and secondary means of detection.

- a. Primary means of detection 1 A F -

The primary means of detection of operational state or condition.

- b. Secondary means of detection 1 A F -

The secondary means of detection of operational state or condition.

Built-in-test (BIT)	B
Manual test equipment (MTE Common)	M
Manual test equipment (MTE Peculiar)	N
Automatic test equipment (ATE Common)	A
Automatic test equipment (ATE Peculiar)	P
Human detection	H

238 MEASUREMENT BASE (MB) 1 A F -

MIL-STD-1388-2B
APPENDIX E

A single position code which identifies the measurement unit for a particular operating time period or number of events.

Message units	A
Cycles	C
Days	D
Flight hours	F
Minutes	G
Hours	H
Kilometers	K
Landings	L
Miles	M
Operating hours	O
Rounds	R
Starts	S
Months	T
Underway/steaming hours	U
Years	Y
Arrestments	E
Catapults	B

ANNUAL OPERATING REQUIREMENT MEASUREMENT BASE. An MB associated with the AOR.

ENGINEERING FAILURE MODE MEAN TIME BETWEEN FAILURE MEASUREMENT BASE. An MB for the engineering failure mode MTBF.

FAILURE RATE MEASUREMENT BASE. An MB for the failure rate.

MAINTENANCE INTERVAL MEASUREMENT BASE. An MB for the maintenance interval.

MEAN MISSION DURATION MEASUREMENT BASE. An MB for the mean mission duration.

MEAN TIME BETWEEN FAILURE OPERATIONAL MEASUREMENT BASE. An MB for the operational mean time between failure.

MEAN TIME BETWEEN FAILURE TECHNICAL MEASUREMENT BASE. An MB for the technical mean time between failure.

MEAN TIME BETWEEN MAINTENANCE ACTIONS OPERATIONAL MEASUREMENT BASE. An MB for the operational mean time between maintenance actions.

MEAN TIME BETWEEN MAINTENANCE ACTIONS TECHNICAL MEASUREMENT BASE. An MB for the technical mean time between maintenance actions.

MEAN TIME BETWEEN MAINTENANCE INDUCED MEASUREMENT BASE. An MB for the mean time between maintenance induced.

MEAN TIME BETWEEN MAINTENANCE NO DEFECT MEASUREMENT BASE. An MB for the mean time between maintenance no defect.

MIL-STD-1388-2B
APPENDIX E

MEAN TIME BETWEEN PREVENTIVE MAINTENANCE MEASUREMENT BASE. An MB for the mean time between preventive maintenance.

MEAN TIME BETWEEN REMOVALS MEASUREMENT BASE. An MB for the mean time between removals.

OPERATING TIME MEASUREMENT BASE. An MB for the operating time.

TASK AOR MEASUREMENT BASE. An MB which corresponds to the AOR and is associated with the task frequency.

WEAROUT LIFE MEASUREMENT BASE. An MB for the wearout life.

239 METHOD OF PRESERVATION 2 X F -

A code which defines the preventive measures to forestall deterioration resulting from exposure to atmospheric conditions during storage and shipment. For applicable codes, see MIL-STD-2073-1 and MIL-STD-2073-2.

240 MILITARY DISTANCE CLASSIFICATION 65 X L -

Identification of the military quantity distance class and storage compatibility groups for the item being transported. Reference AFR 71-4, Preparing Hazardous Materials for Military Air Shipments, for instructions.

241 MILITARY LOAD CLASSIFICATION (EMPTY/
LOADED) 4 N - AS

Identification of the military load classification number (for military bridges). The classification number empty is against the operational weight empty, DED 276. The classification number loaded is against the operational weight loaded, DED 276.

Classification number empty 2 N R -

Classification number loaded 2 N R -

242 MILITARY UNIT TYPE 240 X L -

The specific types of military units that will use or transport the system/equipment.

243 MINIMUM EQUIPMENT LIST INDICATOR 1 A F -

A one-position code which indicates whether the end item can be dispatched on its assigned mission with the item under analysis inoperative.

End item can be dispatched. Y

End item can not be dispatched. N or blank

244 MINIMUM EQUIPMENT LIST NARRATIVE 65 X - -

MIL-STD-1388-2B
APPENDIX E

Narrative specifying any limitations on the end item when dispatched on its assigned mission with the analysis item inoperative.

245 MINIMUM REPLACEMENT UNIT (MRU) 3 N R -

A minimum replacement unit quantity indicating the minimum quantity of an item that is normally replaced/installed upon failure or scheduled replacement.

246 MISSION PHASE CODE (MPC) 1 X F -

A one-position code developed by the performing activity that uniquely identifies a Mission Phase/Operational Mode, DED 247. Codes are A-Z, 0-9 and *. The asterisk indicates that the information contained for a particular item is applicable to all mission phases.

247 MISSION PHASE/OPERATIONAL MODE 65 X - -

A concise statement of the mission phase/operational mode in which the failure occurs. Where subphase, event, or time can be defined from the system definition and mission profiles, the most definitive timing information should also be described for the assumed time of failure occurrence.

248 MOBILE FACILITY CODE 1 A F -

A code which expresses the applicability of the SE to mobile facilities. The following codes may be used:

SE required for mobile facility only	V
SE not suitable for mobile facilities	X
Support not restricted to mobile facilities or other site categories	N

249 MOBILITY TYPE 1 A F -

A code which indicates the system/equipment type of mobility.

Skid	A
Tracked	B
Wheeled	C
Other	D

250 MODEL LOAD (HIGHWAY) 1 A F -

The payload capacity of the transporter (truck, trailer, etc.)

Less than 5-ton payload capacity	A
Five-ton to 10-ton payload capacity	B
Greater than 10-ton payload capacity	C

251 MODEL TYPE (HIGHWAY) 19 X L -

The model type and number of the transporter.

MIL-STD-1388-2B
APPENDIX E

252 MODIFICATION OR CHANGE 1 A F -

A single-letter code indicating whether the need for TMDE is a result of a modification or change to the end item.

Yes Y
No N

253 NATIONAL STOCK NUMBER AND RELATED DATA 20 X - -

A number assigned under the Federal Cataloging Program/North Atlantic Treaty Organization (NATO) codification of equipment system to each approved item identification which provides a unique identification of an item of supply within a specified Federal Supply Classification (FSC). The field consists of a three-character prefix, a 13-character National Stock Number (NSN) and a four-character suffix code as follows:

a. Prefix
Cognizance code 2 X F -
Materiel control code 1 X F -

b. NSN

Consists of the following subfields:

Federal supply classification (FSC) 4 N F -
National item identification number (NIIN) 9 X F -

NOTE: An alphanumeric NIIN is used to document management control or temporarily assigned numbers prior to final NSN assignment. Final NSNs are completely numeric.

ALTERNATE NATIONAL STOCK NUMBER FEDERAL SUPPLY CLASSIFICATION. The FSC of the NSN for an item which may be used in lieu of the SE under analysis.

ALTERNATE NSN NATIONAL ITEM IDENTIFICATION NUMBER. The NIIN portion of the NSN for an item which may be used in lieu of the SE under analysis.

CONTAINER NSN. A number which provides a unique identification to a reusable (long file) container within the appropriate FSC.

INTEROPERABLE ITEM NATIONAL ITEM IDENTIFICATION NUMBER. The NIIN of the interoperable equipment.

INTEROPERABLE ITEM NATIONAL STOCK NUMBER FEDERAL SUPPLY CLASSIFICATION. The FSC of the interoperable equipment.

c. Suffix
Special materiel identification code/ 2 X F -
Materiel management aggregation code
Activity code 2 X F -

MIL-STD-1388-2B
APPENDIX E

For applicable codes, see DOD 4100.38-M.

- 254 NET EXPLOSIVE WEIGHT 10 N R -
- The next explosive weight, in pounds per package or per pallet, of the item for all Department of Transportation class A or B explosives. The next explosive weight for class C explosives is required for items shipped to Hawaii, Italy, and United Kingdom per DOD 4500.32R and AFR 71-4.
- 255 NEW OR MODIFIED FACILITY NARRATIVE CODE 1 A F -
- A code that indicates the new or modified facility narrative.
- Facility design criteria, DED 105 A
Facility installation lead time, DED 106 B
Facility task area breakdown, DED 122 C
Facilities utilization, DED 111 D
Facilities requirement, DED 108 E
Facility unit cost rationale, DED 123 F
Facility justification, DED 188 G
Type of construction, DED 482 H
Utilities requirement, DED 502 I
- 256 NEW OR MODIFIED SKILL NARRATIVE CODE 1 A F -
- A code that indicates the new or modified skill narrative.
- New or modified skill additional requirements, DED 007 A
Educational qualifications, DED 094 B
Skill justification, DED 188 C
Additional training requirements, DED 012 D
- 257 NEW OR MODIFIED SKILL SPECIALTY CODE (SSC) 7 X L -
- The SSC which is new or modified.
- 258 NEXT HIGHER ASSEMBLY PROVISIONING LIST ITEM SEQUENCE NUMBER (NHA PLISN) 5 X L -
- The PLISN assigned to the item's next higher assembly. This may be the PLISN assigned to the item's kit, or the PLISN assigned to a major component which is a planned overhaul candidate for which the item is required.
- 259 NEXT HIGHER ASSEMBLY PROVISIONING LIST ITEM SEQUENCE NUMBER INDICATOR (NHA IND) 1 X F -
- A code which indicates the type of data entered in NHA PLISN, DED 258.
- NHA N
Major component C

MIL-STD-1388-2B
APPENDIX E

	Both NHA and major component	B
	Kit	*
	Fabricated item	F
	Assembled item	A
	End item	E
260	NON-OPERABILITY, FRAGILITY FACTOR (NOFF)	2 N R -
	The maximum force acceleration or deceleration, expressed in units of gravity (Gs) that can be applied to an item in its non-operating state without causing physical damage or change in its operational characteristics. The NOFF should only be completed for an item that has been determined, or assumed to have a non-operational fragility tolerance of less than 40 Gs.	
261	NOT REPARABLE THIS STATION (NRTS)	3 N R -
	The percent of estimated reparable generations which the intermediate repair shops will be unable to repair and therefore, will be processed to a technical repair center (depot).	
262	NUMBER OF OPERATING LOCATIONS	4 N R -
	The number of locations which will receive and operate the item under analysis.	
263	NUMBER OF SHOPS	2 N R -
	The number of maintenance locations available to perform repair at each maintenance echelon.	
264	NUMBER OF SKIDS	2 N R -
	The total number of skids of the system/equipment that is being transported.	
265	NUMBER OF SYSTEMS SUPPORTED	6 N R -
	The average number of systems or end items supported by a maintenance level.	
266	NUMBER TYPE	1 A F -
	A code that specifies whether the item is an interoperability item or a mode of transport item.	
	Interoperability item	I
	Mode of transport item	M
267	OPERATING AND SUPPORT COST	8 N R -
	The projected annual ownership cost in dollars per end item of ATE/TMDE averaged over its expected useful life.	

MIL-STD-1388-2B
APPENDIX E

- 268 OPERATING DIMENSIONS 14 X - AS
- Dimensions of an item of support/test equipment or training material while it is in the operational configuration mode. Composed of the following subfields:
- a. Length 4 N R 1
 - b. Width 4 N R 1
 - c. Height 4 N R 1
- 269 OPERATING TIME 6 N R 2
- The operating time of the item under analysis per use/mission derived from the system definition.
- 270 OPERATING WEIGHT 6 N R 1
- The operating weight, in pounds, of the item under analysis.
- 271 OPERATION LEVEL 2 N R -
- The number of days worth of stock intended to sustain normal operations during the interval between receipt of replenishment shipment and submission of subsequent replenishment requisition. Does not include either safety level or order ship time quantities.
- 272 OPERATION LIFE 2 N R -
- The number of years the item is expected to be in service.
- 273 OPERATIONAL AVAILABILITY (A_o) 8 N R 6
- The probability that, when used under stated conditions, a system will operate satisfactorily at any time. This differs from achieved availability in that A_o includes standby time and administrative and logistic delay time. A_o may be expressed by the following formula:
- $$A_o = \frac{OT + ST}{OT + ST + TPM + TCM + ALDT}$$
- Where:
- OT = Operating time per calendar year
 - ST = Standby time
 - TPM = Total preventive maintenance time per calendar year
 - TCM = Total corrective maintenance time per calendar year
 - ALDT = Administrative and logistics delay time spent waiting for parts, maintenance personnel, or transportation per calendar year
- REQUIRED OPERATIONAL AVAILABILITY. An A_o representing the supportability requirement/specification A_o .
- 274 OPERATIONAL MISSION FAILURE DEFINITION 65 X - -

MIL-STD-1388-2B
APPENDIX E

A narrative description of the guidelines to be followed to identify operational mission failures for the system/equipment being documented. Operational mission failures are those failures which, upon occurrence, would prevent the system/equipment from performing mission essential functions. Mission essential functions are the minimum operational tasks which the system must be capable of performing to complete its mission successfully.

275 OPERATIONAL REQUIREMENT INDICATOR 1 A F -

A code indicating whether the operational requirement specified pertains to a wartime or peacetime scenario.

Wartime W
Peacetime P

RELIABILITY OPERATIONAL REQUIREMENT INDICATOR. An ORI specified for the reliability of an item.

276 OPERATIONAL WEIGHT (EMPTY AND LOADED) 8 N - AS

The operational weight in tons of the system/equipment being transported. It is divided into two subfields:

Empty 4 N R 1

Loaded 4 N R 1

277 OPERATIONS/MAINTENANCE (O/M) LEVEL 1 A F

Codes that are assigned to indicate the maintenance levels authorized to perform the required maintenance function.

Operator/Crew/Unit-Crew. Operations and maintenance which are the responsibility of and performed by the using organization by the system equipment operator/crew on its assigned equipment. Its phases normally consist of inspecting, servicing, lubricating, adjusting, and replacing of parts, minor assemblies, and subassemblies.

Operator/Crew/Unit-Crew C

Organizational/On Equipment/Unit-Organizational. Maintenance which is the responsibility of and performed by the using organization on its assigned equipment. Its phases normally consist of inspecting, servicing, lubricating, adjusting and replacing of parts, minor assemblies and subassemblies.

Organizational/On Equipment/Unit-Organizational O

Intermediate/Direct Support/Afloat/Third Echelon/Off Equipment/Intermediate-Forward. The next higher maintenance level after Organizational/On Equipment/Unit-Organization. Titles of "Direct Support" and "Third Echelon" are associated with ground support forces;

MIL-STD-1388-2B
APPENDIX E

"Intermediate" and "Off Equipment" are with nautical and aviation organizations. Maintenance at this level is the responsibility of, and performed by, designated maintenance activities for direct support of using organizations. Its phases normally consist of: calibration, repair or replacement of damaged or unserviceable parts, components or assemblies; emergency manufacture of nonavailable parts; and technical assistance to using organizations.

Intermediate/Direct Support/Afloat/Third Echelon/Off Equipment/Intermediate-Forward F

Intermediate/General Support/Ashore/Fourth Echelon/Intermediate-Rear. Maintenance performed on material requiring major overhaul or a complete rebuild of parts, subassemblies and end items, including manufacture of parts, modification, testing and reclamation as required. Includes capabilities described in Intermediate/Direct Support/Afloat/Third Echelon/Off Equipment/Intermediate-Forward.

Intermediate/General Support/Ashore/Fourth Echelon/Intermediate-Rear H

Intermediate/Ashore and Afloat. A maintenance level used to identify those maintenance tasks which can be accomplished at the intermediate level both Ashore and Afloat.

Intermediate/Ashore and Afloat G

Depot/Shipyards (D). The highest level of maintenance activities. Maintenance performed on material requiring major overhaul or a complete rebuild of parts, subassemblies or end items, including manufacture of parts, modification, testing and reclamation as required. Depot maintenance serves to support lower categories of maintenance by providing technical assistance and performing whatever maintenance is beyond their responsibility. Depot maintenance provides stocks of serviceable equipment by using more extensive facilities for repair than are available in lower level maintenance activities.

Depot/Shipyards D

Specialized Repair Activity (SRA). A level of maintenance usually characterized by the capability to perform maintenance functions requiring specialized skills, disciplined quality control, highly sophisticated and expensive special tools, and TMDE. Its phases normally consist of adjustments, calibration, alignment, testing, troubleshooting, assembly, disassembly, fault isolation, and repair of unserviceable parts, modules, and printed circuit boards (PCB).

Specialized Repair Activity L

MODELING OPERATIONS AND MAINTENANCE LEVEL. The O/M level associated with supportability modeling information.

OPERATIONS AND MAINTENANCE LEVEL FROM. The O/M level from which a spare/repair part is shipped.

MIL-STD-1388-2B
APPENDIX E

OPERATIONS AND MAINTENANCE LEVEL TO. The O/M level where a spare/repair part is received.

PRINTED CIRCUIT BOARD REPAIR OPERATIONS/MAINTENANCE LEVEL. The O/M level at which PCBs of the SE under analysis are repaired.

SUPPORT EQUIPMENT CALIBRATION OPERATIONS/MAINTENANCE LEVEL. The O/M level at which the SE under analysis is calibrated.

SUPPORT EQUIPMENT REPAIR OPERATIONS/MAINTENANCE LEVEL. The O/M level at which the SE under analysis is repaired.

278 OPERATOR'S MANUAL 16 X L -

The Technical manual/technical order designation of the military operators manual, or the number of the commercial manual applicable to the item.

279 OPTIONAL PROCEDURE INDICATOR 1 X F -

A code which indicates whether various types of optional packaging procedures are allowable or whether no deviations from the packaging data are permitted. For applicable codes, see MIL-STD-2073-1 and MIL-STD-2073-2.

280 ORGANIZATIONAL/ON EQUIPMENT/UNIT 60 N - AS
OPERATIONS AND MAINTENANCE
REQUIREMENTS

Data documenting the operations and organizational maintenance requirements for the system/equipment under development. It consists of the following subfields.

a. Daily Inspection 10 N - AS

An inspection for latent defects to a greater depth than the Preoperative/Preflight/Postflight Inspection. It includes the elements of the Preoperative/Preflight/Postflight Inspection and satisfies the requirement for Preoperative/Preflight/Postflight Inspection if it is conducted against the same hardware item. Daily inspections are performed before the first operation/flight of the day or after the last flight of the day.

This field is composed of two subfields:

(1) Mean Elapsed Time, DED 224 5 N R 2

(2) Mean Man-hours, DED 225 5 N R 2

b. Mission Profile Change 10 N - AS

The process of changing the operational configuration of the end item in order to accomplish a different mission. Consists of the following subfields:

MIL-STD-1388-2B
APPENDIX E

(1) Mean Elapsed Time, DED 224. 5 N R 2

(2) Mean Man-hours, DED 225. 5 N R 2

c. Periodic Inspection 10 N - AS

An inspection with a regular or recurring interval other than daily, preoperational, post-operational or calendar. Consists of the following subfields:

(1) Mean Elapsed Time, DED 224 5 N R 2

(2) Mean Man-Hours, DED 225 5 N R 2

d. Post Operative Inspection 10 N - AS

An inspection conducted immediately after each operation to determine defects that may have developed during the operation. Consists of the following subfields:

(1) Mean Elapsed Time, DED 224 5 N R 2

(2) Mean Man-Hours, DED 225 5 N R 2

e. Preoperative Inspection 10 N - AS

An inspection conducted before each operation to verify that the equipment has been properly serviced and to detect defects that would have an adverse affect on the operation. Consists of the following subfields:

(1) Mean Elapsed Time, DED 224 5 N R 2

(2) Mean Man-Hours, DED 225 5 N R 2

f. Turnaround 10 N - AS

The time required to return item for use between missions. Consists of the following subfields:

(1) Mean Elapsed Time, DED 224 5 N R 2

(2) Mean Man-Hours, DED 225 5 N R 2

281 OVERHAUL REPLACEMENT RATE (ORR) 3 N R 2

A rate that represents an estimate of the percent of time that a particular support item will be replaced in the next higher repairable assembly/end item during overhaul.

282 PACKAGING CATEGORY CODE 4 X F -

MIL-STD-1388-2B
APPENDIX E

A code which indicates physical and chemical characteristics of an item and identifies weight/fragility and preservative relative to the packaging of an item. For applicable codes, see MIL-STD-2073-1 and MIL-STD-2073-2.

283 PACKING CODE 3 X - -

A series of codes which identify packing requirements. Consists of the following subfields:

a. Level A Packing (A) 1 X F -

A code assigned to identify level "A" packing requirements. For applicable codes, see MIL-STD-2073-1 and MIL-STD-2073-2.

b. Level B Packing (B) 1 X F -

A code assigned to identify level "B" packing requirements. For applicable codes, see MIL-STD-2073-1 and MIL-STD-2073-2.

c. Minimum Packing (C) 1 X F -

A code assigned to identify minimum packing requirements. For applicable codes, see MIL-STD-2073-1 and MIL-STD-2073-2.

284 PARAMETERS 63 X - -

A field divided into nine subfields which describes technical capabilities/characteristics that an item of operational equipment, TMDE, or calibration equipment/standard is capable of measuring/generating, or which are to be measured on the UUT. Classified parameters and transistor logic levels are not listed in the CMRS. Classified parameters are listed in a classified supplement or appendix to the CMRS and that document appropriately controlled.

a. Parameter Grouping Code (PGC) 2 A F -

A two character code linking the requirements set by the unit under test to the capabilities of the SE.

SE PARAMETER GROUP CODE. A PGC of the SE.

SE UUT PARAMETER GROUP CODE. A PGC of the SE UUT which must match the PGC of the corresponding SE.

UUT PARAMETER GROUP CODE. A PGC of the unit under test (UUT) which must match the PGC of the corresponding SE.

b. Input/Output (I/O) 1 A F -

A code specifying the corresponding parameter of the equipment in question (SE or UUT) as an input into equipment or output from the equipment. Codes are as follows:

MIL-STD-1388-2B
APPENDIX E

Input into equipment	I
Output from equipment	O

SE UUT PARAMETER INPUT/OUTPUT CODE. An I/O code of the SE UUT.

SUPPORT EQUIPMENT INPUT OUTPUT CODE. An I/O code of the SE.

UUT PARAMETER INPUT/OUTPUT CODE. An I/O code of the UUT.

c. Parameter 12 X L -

The characteristic (e.g., volts, DC, Hertz, etc.) which an item of TMDE is capable of measuring or which are to be measured on the UUT.

SE UUT PARAMETER. A parameter of the SE UUT which requires measurement by the SE under analysis.

SUPPORT EQUIPMENT PARAMETER. A parameter which the SE under analysis is to measure.

UUT PARAMETER. A parameter of the SE UUT which requires measurement by the SE under analysis.

d. Range-From 10 D - -

The lowest value of a particular parameter which can be measured or generated.

SE UUT PARAMETER RANGE FROM. The lowest value of the parameter of the SE UUT that the SE under analysis must measure.

SUPPORT EQUIPMENT PARAMETER RANGE FROM. The lowest value of the parameter that the SE is capable of measuring.

UUT PARAMETER RANGE FROM. The lowest value of the parameter of the UUT that the SE under analysis must measure.

e. Range-To 10 D - -

The highest value of a particular parameter which can be measured or generated.

SE UUT PARAMETER RANGE TO. The highest value of the parameter of the SE UUT that the SE under analysis must measure.

SUPPORT EQUIPMENT PARAMETER RANGE TO. The highest value of the parameter that the SE is capable of measuring.

UUT PARAMETER RANGE TO. The highest value of the parameter of the UUT that the support equipment under analysis must measure.

f. Accuracy 26 X L -

A narrative description of the tolerances of the corresponding parameter.

MIL-STD-1388-2B
APPENDIX E

SE UUT PARAMETER ACCURACY. The amount of accuracy of the parameter of the SE UUT that the SE under analysis must measure.

SUPPORT EQUIPMENT PARAMETER ACCURACY. The amount of accuracy of the parameter that the SE is capable of measuring.

UUT PARAMETER ACCURACY. The amount of accuracy of the parameter of the UUT that the support equipment under analysis must measure.

g. Range/Value Code (R/V) 1 A F -

A code used to identify specific parameters as either a "range" or a specific "value". List specific value parameters in the "Range-From" block.

Range	R
Value	V

SE UUT PARAMETER RANGE/VALUE CODE. The R/V of the SE UUT.

SUPPORT EQUIPMENT PARAMETER RANGE/VALUE CODE. The R/V of the SE.

UUT PARAMETER RANGE/VALUE. The R/V of the UUT.

h. Operational/Specification Parameter 1 A F -

A code indicating whether the associated parameter is operational or specification parameter of the UUT.

Operational parameter	O
Specification parameter	S

285 PASS THROUGH PRICE 8 N R -

The cost added to items bought by a prime contractor which are delivered to the government with little or no value added by the prime contractor.

286 PERCENTILE 2 N F -

The percentage of all corrective maintenance actions that can be accomplished within a specified maximum time to repair.

MAINTENANCE LEVEL PERCENTILE. The percentile within the specified maximum time to repair for a given operations/maintenance level.

REQUIRED PERCENTILE. The percentile associated with the requirement maximum time to repair.

287 PERFORMANCE STANDARDS 3 A L -

Signifies when the following performance standards are required for an individual task.

MIL-STD-1388-2B
APPENDIX E

	Supervision required - A	Y or N
	Precision required - B	Y or N
	Time standard - C	Y or N
288	PERSON IDENTIFIER	3 X L -
	A three-position code identifying each person required to perform the subtask (codes "A" through "999"). Within a task, a given Person ID relates to a specific "Job" and a specific Skill Specialty Code.	
289	PERSONNEL TURNOVER RATE	4 N - AS
	The portion of personnel, expressed in percent per year, leaving their SSC which will be replaced by new personnel requiring training.	
	a. Military	2 N R -
	The military turnover rate.	
	b. Civilian	2 N R -
	The civilian turnover rate.	
290	PHYSICAL AND MENTAL REQUIREMENTS	65 X - -
	A narrative description identifying any unique physical or mental personnel attributes required or recommended as prerequisites to full qualification in the applicable task.	
291	PHYSICAL SECURITY/PILFERAGE CODE	1 X F -
	A code which indicates the security classification or pilferage control for physical assets. For applicable codes, see DOD 4100.38-M.	
292	PILOT REWORK/OVERHAUL CANDIDATE	1 A F -
	A code indicating selection status of certain complex assemblies/components considered for pilot rework/overhaul (PR/O) as part of the preoperational support program.	
	Item is nominated for PR/O program	Y
	Item is not nominated for PR/O program	N
	Item is approved as an PR/O candidate by the requiring authority	A
	Items nominated are those which require additional skills, training, support and test equipment, facilities, and technical data to ensure a rework/overhaul capacity concurrent with government support of the end item. Consideration shall be given to both intermediate rework and depot level overhaul items.	
293	PRECIOUS METAL INDICATOR CODE (PMIC)	1 X F -

MIL-STD-1388-2B
APPENDIX E

A code which indicates the amount and type of precious metal contained in a specific reference numbered item. For applicable codes, see DOD 4100.38-M.

294 PREPARING ACTIVITY 25 X L -

The name of the activity preparing SE data.

295 PRESERVATION MATERIAL CODE 2 X F -

A code which indicates the material used to prevent or inhibit corrosion or deterioration of an item. For applicable codes, see MIL-STD-2073 series.

296 PREVENTIVE MAINTENANCE CHECKS AND SERVICES (PMCS) INDICATOR CODE 1 A F -

A code which indicates whether or not the task code is applicable to the PMCS tables.

Task is applicable to PMCS table Y
Task is not applicable to PMCS table N

297 PRIOR ITEM PROVISIONING LIST ITEM SEQUENCE NUMBER (PRIOR ITEM PLISN) 5 X L -

The PLISN which appeared on the Interim Support Items List, the Long Lead Times Items List, or first appearance of item in incremental provisioning submittals.

298 PROCUREMENT QUANTITY 3 N R -

The number of systems/equipment being procured.

299 PRODUCTION LEAD TIME (PLT) 2 N R -

The computed or expected time interval in months between placement of a new contract and shipment of the first deliverable quantity.

300 PRODUCTIVITY FACTOR 3 N R 2

This factor is used to account for nonproductive time and has the effect of increasing manpower requirements for performing maintenance. For instance, if the soldier's scheduled work day is 8 hours, he may only be available for 6 hours to do maintenance due to other duty assignments, in this case, the productivity factor is $((8-6)/8) + 1 = 1.25$.

301 PROGRAM ELEMENT 3 X L -

A code consisting of up to three alphanumeric characters identifying the applicable SE program element specified by the requiring authority.

MIL-STD-1388-2B
APPENDIX E

302 PROGRAM PARTS SELECTION LIST 1 A F -
(PPSL)

A code indicating whether the part is included within contractually controlled Federal Supply Classes (FSC), as outlined in MIL-STD-965, Parts Control Program. Codes assigned are as follows:

Part is included in contractually controlled FSCs and approved for use in PPSL A

Part is included in contractually controlled FSCs and not approved for use in PPSL N

303 PROGRAM SUPPORT INVENTORY CONTROL 2 X F -
POINT

A government code to identify the service supporting Inventory Control Point (ICP) where the using SE weapon/inventory manager is located. Codes are as follows:

<u>Service/Agency</u>	<u>ICP</u>	<u>Code</u>
Marine Corps USAF	Marine Corps Logistics Base, Albany, GA	PA
	Sacramento ALC, CA	TA
	Warner Robins ALC, Robins AFB, GA	TG
	San Antonio ALC, Kelly AFB, TX	SE
	Ogden ALC, Hill AFB, UT	SU
	Oklahoma City ALC, Tinker AFB, OK	SX
	AF Cryptologic Support Center (ESC), San Antonio, TX	SJ
Army	Communications and Electronics Materiel Readiness Command, Fort Monmouth, NJ	CL
	Tank Automotive Command, Warren, MI	AZ
	Missile Command, Redstone Arsenal, AL	BD
	Armament Munitions & Chemical Command Rock Island, IL	BF
	Aviations Systems Command, St. Louis, MO	CT
	Troop Support Command, St. Louis, MO	AJ
Navy	COMSEC Logistics Activity, Fort Huachuca, AZ	CM
	Ships Parts Control Center, Mechanicsburg, PA	HD
FAA	Aviation Supply Office, Philadelphia, PA	KE
	Mike Monroney Aeronautical Center Oklahoma City, OK	48

304 PROPER SHIPPING NAME 60 X L -

The proper shipping name of the item to be transported, if this item is categorized as a hazardous material (e.g., CFR 49, UNTDF).

MIL-STD-1388-2B
APPENDIX E

305 PRORATED EXHIBIT LINE ITEM NUMBER 6 X - -
(PRORATED ELIN)

The ELIN which was assigned to the previous item procurement on an item affected by proration.

306 PRORATED QUANTITY 6 N R -

The specific quantity remaining on order for the Prorated Exhibit Line Item Number.

307 PROVISIONING CONTRACT CONTROL NUMBER 6 X F -
(PCCN)

A number assigned by the requiring authority to identify a specific contract or a group of end items/components that can have many configurations/models.

NOTE: The first position shall be alphabetic and will identify the applicable military service/agency provisioning designator having responsibility for the item(s) being processed.

First position codes are as follows:

Army	A-I
National Security Agency	J
Federal Aviation Administration	K
Marine Corps	L&M
Navy	N-R
Air Force	S-X
Coast Guard	Y
Defense Logistics Agency	Z

SYSTEM/EI PROVISIONING CONTRACT CONTROL NUMBER. The PCCN of the system/end item as a model (A indenture code) item.

308 PROVISIONING LIST CATEGORY CODE 1 A F -
(PLCC)

A code which indicates whether the item is documented on another list or is a government furnished item.

Government furnished	A
Interim support items	B
Long lead time item	C
Tools and test equipment	D
Common and bulk item	E
Repairable items	F
Interim released item	G
Installation and checkout item	H
Authorization stockage list item	J
Recommended buy list item	K
Prescribed load list item	L
System support package component list item	M

MIL-STD-1388-2B
APPENDIX E

309 PROVISIONING LIST ITEM SEQUENCE NUMBER (PLISN) 5 X L -

A sequentially assigned value for all items contained in the system/equipment breakdown. The codes are as follows:

AAAA through 9999 (less I and O)

The numbering of line items shall begin with AAAA and progress through 9999, or as specified by the requiring authority.

a. When an item is contained in both a common and bulk items list (CBIL) and a provisioning parts list (PPL), it may be assigned the same PLISN on both lists. When an item appears on a CBIL only, the PLISN may be unique (i.e., will not duplicate any PLISN in the PPL).

b. The fifth position of the PLISN shall be used to indicate additions to the breakdown. For this purpose, the letters A through Z, inclusive (except I and O) and the numbers 0 through 9, inclusive, shall be used starting with the letter A for the first addition and continuing sequentially through the alphabet and then through the numeric characters. An add entry, identified by the letters A, B, C, etc., in the fifth position of the PLISN, is sequenced for inserting new items in the provisioning list either as a first or subsequent (same as) item entry, which will be used for either regular additions or replacement items. If the item listed is not an addition, the fifth position shall be left blank.

SYSTEM/EI PROVISIONING LIST ITEM SEQUENCE NUMBER. The PLISN of the system/end item as a model (A indenture code) item.

310 PROVISIONING NOMENCLATURE 65 X - -

A description in narrative form used to provide additional identification of an item to be included in a repair parts manual.

311 PROVISIONING REMARKS 65 X - -

Narrative clarification of provisioning data.

312 PROVISIONING SYSTEM IDENTIFIER CODE 3 X L -

A unique code assigned to a system/end item. The code will be assigned by the requiring authority.

313 PROVISIONING TECHNICAL DOCUMENTATION SELECTION CODE 11 A - -

A code which indicates that an item is to be selected for a specific provisioning technical documentation list. If the item applies to a particular list, a "Y" is entered. Leave blank if the item does not apply. The lists for which items can be selected are as follows:

MIL-STD-1388-2B
APPENDIX E

- a. Long Lead Time Items List (LLTIL) 1 A F -
- b. Provisioning Parts List (PPL) 1 A F -
- c. Short Form Provisioning Parts List (SFPPL) 1 A F -
- d. Common and Bulk Items List (CBIL) 1 A F -
- e. Repairable Items List (RIL) 1 A F -
- f. Interim Support Items List (ISIL) 1 A F -
- g. Post Conference List (PCL) 1 A F -
- h. Tools and Test Equipment List (TTEL) 1 A F -
- i. System Configuration Provisioning List (SCPL) 1 A F -
- j. As designated by requiring authority (one) 1 A F -
- k. As designated by requiring authority (two) 1 A F -

Note: Design Change Notice processing occurs against an established list (normally the PPL or PCL).

- 314 PROVISIONING UNIT OF MEASURE/
ISSUE PRICE CODE 1 A F -

A code used to indicate the Unit of Measure (UM) or Unit of Issue (UI) Price, which will be used for provisioning technical documentation, when multiple UM PRICES are entered.

UM/UI Price used Y
UM/UI Price not used N

UI PRICE PROVISIONING. The provisioning UI price.

UM PRICE PROVISIONING. The provisioning UM price.

- 315 QUALITATIVE AND QUANTITATIVE MAINTAINABILITY REQUIREMENTS: NUCLEAR HARDENED CHARACTERISTICS, FAIL SAFE, ENVIRONMENTAL, ETC. 65 X - -

A narrative description identifying maintainability design constraints and characteristics that must be considered during the design process, to include:

MIL-STD-1388-2B
APPENDIX E

a. Fail Safe Requirements. A narrative description identifying required fail safe characteristics (i.e., redundancy, back-up systems, built-in-test and warning equipment, fail safe provisions necessary to protect the equipment from serious damage after failure, and design features to prevent injury to personnel subsequent to equipment failure).

b. Environmental Considerations. A narrative description identifying the applicable environmental conditions within which the item can operate satisfactorily. This information should include limitations, sensitivity factors, etc., that can affect the performance and reliability of the item installed in the system/equipment. Limiting factors such as the following should be considered: shock limits; vibration limits; ambient temperature ranges; operating temperatures in area (compartment) where item is installed in the system/equipment; humidity factors; altitude factors; magnetic interference; dust and dirt factors; salts or other corrosive atmosphere; and, light sensitivity. The narrative should include that portion of the system/equipment environmental impact statement which relates to the effects of the support system on the environment.

c. Nuclear Hardened Characteristics. A narrative description identifying the design characteristics which provide minimum nuclear survivability of the item. No design changes should be made without survivability/vulnerability evaluation to avoid inadvertent degradation of nuclear hardness.

316 QUANTITY PER ASSEMBLY
(QTY/ASSY)

4 A L -
4 N R -

The total number of times a line item is used in the assembly of which it is a part. If the quantity is unknown or cannot be determined, specify the quantity by "V" (variable) or as specified by the provisioning activity.

Option 1. The contractor shall enter the total number of times the line item is used in the assembly of which it is a part. Note: Option 1 QTY/EI can only be used with Option 1 QTY/ASSY.

Option 2. For provisioning parts lists (PPLs) in reference designation format, enter the number of times the item appears at the location in the end item documented by the PPL. When an assembly is broken down by individual piece parts at its first appearance, the quantity for the assembly and for each piece part at each location shall be the number of times it appears in the assembly multiplied by the number of appearances of the assembly in the end item. For other provisioning lists under option 2, the QTY/ASSY can be considered as the QTY/EI.

Option 3. The contractor shall enter the total number of times the line item is used in the assembly of which it is a part. An assembly only needs to be broken out to its piece parts at its first occurrence on a list. Subsequent appearances of the same assembly shall not be broken out.

MIL-STD-1388-2B
APPENDIX E

SYSTEM/EI QUANTITY PER ASSEMBLY. The quantity per assembly of the system/end item as a model (A indentured) item.

317 QUANTITY PER END ITEM 5 A L -
(QTY/EI) 5 N R -

The total number of times the line item is used in the complete system/equipment. If the quantity is unknown or cannot be determined specify the quantity by "V" (variable) or as specified by the provisioning activity.

Note: The Greek "Σ" or SIGMA represents the mathematical symbol for a series summation while the symbol "TT" or TAU is the mathematical expression for a series multiplication.

Option 1. The quantity per equipment or end item shall be entered only on the first appearance of the line item on the list. Subsequent appearances of the same item should be indicated by printing the letters "REF" in positions 1-3 to indicate that the total number of uses of the item in the equipment or end item has previously been listed. Note: This option can only be used with Option 1 QTY/ASSY.

The following formula applies to option 1:

$$QTY/EI = \sum_{i=1}^N [\prod_{j=1}^M QTY/ASSY_j]^i$$

Where:

- N = Number of applications for unique part
- i = Application of unique part
- M = Number of indenture levels
- j = Indenture level of application

Option 2. The QTY/EI shall be entered only on the first appearance of the item on the list. Subsequent appearances of the same assembly or subassembly should be indicated by printing "REFX" in positions 1-4. Subsequent appearances of the same repair part (i.e., a part which has no lower indentured parts) should be indicated by printing the letters "REF" in positions 1-3. This option can only be used with option 2, QTY/ASSY.

Examples of provisioning lists with a single assembly breakdown using the option 2 QTY/ASSY follow: Note that a separate application (PLISN and LCN) is required for each identical item in the same NHA.

1. For reference designation (RD) oriented equipment.

<u>RD</u>	<u>Reference No.</u>	<u>QTY-ASSY</u>	<u>QTY-EI</u>
-----------	----------------------	-----------------	---------------

MIL-STD-1388-2B
APPENDIX E

1A1	ABC	0003	0003
1A1 R1	PDQ	0003	0006
1A1 R2	PDQ	0003	REF
1A1 MP2	XYZ	0006	0006
1A2	ABC	0000	REFX
1A3	ABC	0000	REFX

2. For nonreference designation oriented equipment:

<u>Indenture Code</u>	<u>Reference No.</u>	<u>QTY-ASSY</u>	<u>QTY-EI</u>
B	ABC	0001	0003
C	PDQ	0003	0006
C	PDQ	0003	REF
C	XYZ	0006	0006
B	ABC	0001	REFX
B	ABC	0001	REFX

The following formula applies to option 2:

$$QTY/EI = \sum_{i=1}^N QTY/ASSY_i$$

Where:

- N = Number of applications for unique part
- i = Application of unique part

Option 3. The QTY/EI shall be entered only on the first appearance of the line item on the list for system/equipment for which the list is prepared, and should equal the total number of appearances of the item in that system/equipment (all appearances of an item may not appear on the list). Subsequent appearances of the same assembly or subassembly should be indicated by printing "REFX" in position 1-4. Subsequent appearances of the same repair part (i.e., a part which has no lower indentured parts) should be indicated by printing the letters "REF" in positions 1-3. This option can only be used with option 3 of the QTY/ASSY.

The following formula applies to option 3:

$$QTY/EI = \sum_{i=1}^N [\sum_{j=1}^M [TT \ QTY/ASSY_j]] + \sum_{k=1}^{P-1} [TT \ QTY/ASSY_1] k] i$$

Where:

- N = Number of applications of unique part (first appearance of NHA only)
- i = Application of unique part
- M = Number of indenture levels
- j = Indenture level of application at first appearance
- P = Number of applications of unique assembly containing unique part

MIL-STD-1388-2B
APPENDIX E

- k = Application of unique part (other than first appearance of a higher assembly)
- Q = Number of indenture levels at assembly application (other than first appearance of a higher assembly)
- l = Indenture level of application (other than first appearance of a higher assembly)

Note: The first product and summation in this formula are performed against the first appearance of an item. These applications are documented in the LSAR hardware breakdown. The second product and summation are performed against subsequent appearances of an item which are not documented in the LSAR (e.g., will not appear on a provisioning list). These item applications are identified by the first appearance of the item in an assembly (either NHA or higher) and the reference number of the higher assembly containing the unique part appearing in multiple applications.

SYSTEM/EI QUANTITY PER END ITEM. The quantity per end item of the system/end item as a model (A indentured) item.

318 QUANTITY PER FIGURE 3 N R -

The total quantity of an item which is depicted by a specific illustration. Quantity per figure is left blank, if the quantity per assembly (DED 316) equals the quantity per figure.

319 QUANTITY PER TASK 5 N R 2

The number of items used to perform the task. For tasks where the items are not used for every occurrence of the task, the quantity per task is the expected average number of items per task.

PROVISION QUANTITY PER TASK. A quantity of the support item being provisioned required for the task.

SUPPORT ITEM QUANTITY PER TASK. A quantity of the SE required for the task.

320 QUANTITY PER TEST 3 N R -

The number of end article system(s)/subsystem(s) or components required to enable the SE end item to perform properly (e.g., other components/subsystems may be required to be intact in order to use the SE).

321 QUANTITY PER UNIT PACK 3 N R -
3 A F -

The number of units of an item packaged as a unit pack (see MIL-STD-2073-2 for codes and explanations).

322 QUANTITY PROCURED 6 N R -

The total quantity of the provisioned item order.

MIL-STD-1388-2B
APPENDIX E

323	QUANTITY SHIPPED	6 N R -	
	The quantity of items affected by the design change notice that have been shipped.		
324	QUANTITY SKILL SPECIALTY CODE AVAILABLE	5 N R -	
	The maximum number of personnel of a given SSC, which will be available to each maintenance unit at a specified level of maintenance, to perform all tasks required for the item under analysis.		
325	RAIL TRANSPORTATION COUNTRY	240 X - -	
	The foreign country(ies) where rail transportation is required.		
326	RAIL USE	5 A L -	
	A code indicating the type of rail use applicable to transport the system/equipment.		
	Continental United States (CONUS) only		C
	Gabaret International De Chargement (GIC) Europe		G
	Envelope A (Europe)		A
	Envelope B (Europe)		B
	AAR Diagram (North America)		U
	Rail transportation not required		N
327	REASON FOR SUPERSEDURE/DELETION	2 X F -	
	A two-position code identifying the reason for an item being superseded by another or deleted. Supersedure codes are F1, F2, and F3. All other codes shall be used only in the case of an item being deleted.		
	Evaluation pending, original SERD only		A1
	Not Essential (luxury item), original SERD only		B1
	Not essential (no maintenance required), original SERD only)		B2
	Not essential (system redesign), SERD revision only		B3
	Not essential (component redesign), SERD revision only		B4
	Not essential (revised maintenance concept), SERD revision only		B5
	Not essential (end article not in configuration)		B6
	Not essential (application already included in basic end article)		B7
	Commercial rework ("D" maintenance level only, original SERD)		C1
	Contractor resubmit, an original SERD must be approved/deleted		D1
	Deleted from inventory		F1
	Superseded for future procurement, use for ECP changed items only		F2
	Alternate		F3
	SERD item is a part of another SE item		G1
	Deletion of an equivalent SERD		H1
	Not SE		I1
	SE for GFE, for CFE end articles only		J1

MIL-STD-1388-2B
APPENDIX E

- 328 RECOMMENDED INITIAL SYSTEM STOCK BUY 3 N R -
A numeric quantity representing the recommended minimum quantity to be bought for system stock.
- 329 RECOMMENDED MINIMUM SYSTEM STOCK LEVEL 3 N R -
A numeric value representing the recommended minimum level of system stock required to support initial deployment of a system/equipment.
- 330 RECOMMENDED RANK/RATE/PAY PLAN/GRADE 7 X - -
Identifies the recommended military rank/rate/civilian grade which is necessary to operate, test, or repair the system/equipment. Consists of the following subfields:
a. Military Rank/Rate 3 X F -
Identifies military personnel by rank/rate. Data chain is composed of two data elements, Military Personnel Class and Pay Level Serial Number, in that order (DOD-5000.12-M, Reference number PA-SN).
Enlisted - E01 through E09
Warrant - W01 through W04
Officer - O01 through O11
Cadet/midshipman - C00
b. Civilian Grade 4 X F -
A plan prescribed by law or other authoritative source that governs the compensation paid an employee (e.g., WG06, WD11, and GS07).
- 331 RECOMMENDED TENDER LOAD LIST QUANTITY (RTLL) 3 N R -
A numeric value representing the recommended quantity required by a tender to provide support to assigned hulls.
- 332 RECURRING 8 N R -
The cost which is subsequent to technical data package availability and does not include developmental costs.
- 333 RECURRING BIN COST 4 N R -
Recurring administrative cost expressed in whole dollars of maintaining a bin for an item in the retail supply system for one year.
- 334 RECURRING CATALOGING COST 4 N R -
Recurring administrative cost expressed in whole dollars of maintaining an item in the wholesale supply system for one year.

335 REFERENCE DESIGNATION

64 X L -

Letters or numbers, or both, used to uniquely identify and locate discrete units, portions thereof, and basic parts of a specific component. The reference designation should result in the arrangement of provisioning lists for electronic and electronic related equipment being in alpha-numeric reference designation order IAW ANSI Y 32.16, or in top-down or disassembly order as directed by the requiring authority. Parts for which reference designations have not been assigned, and for which disassembly sequencing is not possible shall be listed in alpha-numeric part number or related data sequence. (Note: Compression (gang listing) of reference designations under one PLISN: Identical items identified by separate reference designators shall not be combined under a single PLISN unless authorized by the requiring authority). For commercially designed, controlled, and commercially available electronic equipments, compliance with ANSI Y 32.16 is desired, but not mandatory. For reference designation oriented equipments, the reference designation shall be developed IAW ANSI Y 32.16, utilizing option 1 or 2 as prescribed by the requiring authority.

Option 1. Unit Numbering Method. When the unit numbering method is used, unit and subassembly portion (prefix) of the reference designation shall consist of up to 19 positions. The first 19 positions relate to assemblies and subassemblies.

Option 2. Block Numbering Method. When the block numbering method is used, the Joint Electronics Type Designation System (JETDS) nomenclature, (type designation) for the unit shall be entered IAW the block numbering method. For nonelectronic items appearing in electronic equipment, use the identifying number or other symbol used to identify the item (e.g., figure and item number, up to 29 positions).

For nonreference designation oriented equipment, the requiring authority may request one of the following options be used:

Option 3. The volume, figure, and item number from the equipment technical manual will be used in lieu of the reference designation.

Option 4. The plan and piece number (drawing and piece identification) shall be used in lieu of the reference designation.

Option 5. The first precedence reference number (see DED 337, reference number).

336 REFERENCE DESIGNATION CODE
(RDC)

1 A F -

A code which indicates the type of data entered in reference designation block.

Assemblies that are separable or reparable
identified with a reference designation
IAW ANSI Y 32.16 (does not apply to detail
parts within the assembly).

A

MIL-STD-1388-2B
APPENDIX E

Same as A, except this code is to be assigned to assemblies that are inseparable or nonreparable.	U
Items identified with a volume, figure, and index number in the reference designation block.	F
Installation and checkout items that are inseparable or nonreparable.	C
Installation and checkout items that are separable or repairable.	Z
Equipment assemblies/subassemblies identified by drawing or assembly part numbers, with parts identified by circuit reference designator, number, part number or ship's plan and piece number.	H
Repairable accessories, tools, test, and support equipment identified as specified for Code "H".	T
Repairable accessories, nonreparable assemblies, and material, including common and bulk items, not required to be identified with reference designation.	R
Nonrepairable accessories, tools, test and support equipment not included in code "T" breakdown.	S

337 REFERENCE NUMBER 32 X L -

Any number, other than a government activity stock number, used to identify an item of production, or used by itself or in conjunction with other reference numbers to identify an item of supply. Reference numbers include manufacturer's part, drawing, model, type, or source controlling numbers; manufacturer's trade name; specification or standard numbers; and, specification or standard part, drawing, or type numbers (for applicable formats see DOD 4100.38-M). The following precedence for reference number assignment should be used.

a. First Precedent Reference Number. The line item is identified by a government or industry association specifications, drawing, or standard number, e.g., FED, MIL, JAN, AN, NEMA, SAE, which completely identifies the item including its physical, mechanical, electrical and dimensional characteristics. (If the government or industry association specification or standard number does not fully identify the item, then the actual manufacturer's identifying reference number becomes the first precedent reference number.) If the government or industry specification, drawing or standard completely identifies the item, at least one additional reference number (DED 006) citing a manufacturer or vendor reference number must be provided.

MIL-STD-1388-2B
APPENDIX E

b. Second Precedent Reference Number. When the line item is identified as "source control", "altered", or "selected" (MIL-T-3100), the contractors assigned number is used.

c. Third Precedent Reference Number. The item identifying part, drawing, or catalog number of the actual manufacturer who supplies the item. The manufacturer is the company or government activity exercising design control over the item.

AID REFERENCE NUMBER. A reference number of the adapter/interconnector device used in conjunction with the SE.

ARN ITEM REFERENCE NUMBER. A reference number of the primary item under analysis.

AUTOMATIC TEST EQUIPMENT REFERENCE NUMBER. A reference number of the automatic test equipment.

INTEROPERABLE REFERENCE NUMBER. A reference number of the interoperable item.

ITEM REFERENCE NUMBER. A reference number of the primary item under analysis.

OTP REFERENCE NUMBER. A reference number of the operational test program being used in conjunction with the SE.

SE UUT REFERENCE NUMBER. A reference number of the SE that is also a category II calibration and measurement requirements summary item.

S/N PROVISIONING REFERENCE NUMBER. A reference number of the provisioned item under analysis having a serial number relationship.

SUPERCEDURE REFERENCE NUMBER. A reference number of the SE that is superceding or being superceded by the SE under analysis.

SUPPORT EQUIPMENT REFERENCE NUMBER. A reference number of the SE under analysis.

SYSTEM REFERENCE NUMBER. The reference number of the system equipment item which is identical to the piece of SE.

TASK SUPPORT REFERENCE NUMBER. A reference number of the SE identified for a given task.

TASK PROVISION REFERENCE NUMBER. A reference number of the support item which must be provisioned.

TESTING SE REFERENCE NUMBER. A reference number of the SE that is measuring the SE Unit Under Test.

TPI REFERENCE NUMBER. A reference number of the test program instruction used in conjunction with the SE.

MIL-STD-1388-2B
APPENDIX E

UOC PROVISIONING REFERENCE NUMBER. A reference number of the provisioned item under analysis having a Usable On Code relationship.

338 REFERENCE NUMBER CATEGORY CODE 1 X F -
(RNCC)

A code assigned to the reference number to indicate the category or relationship of the number to an NSN or another reference number (for applicable codes see DOD 4100.38-M).

339 REFERENCE NUMBER VARIATION CODE 1 N F -
(RNVC)

A code assigned to a reference number to indicate that the cited number is item identifying, is not item identifying or is a reference number for information only (for applicable codes see DOD 4100.38-M).

340 REGULATORY REQUIREMENTS 65 X - -

Narrative information stating compliance with the regulatory requirements (Title 49, Code of Federal Regulations).

341 RELIABILITY AVAILABILITY MAINTAINABILITY 1 A F -
CHARACTERISTICS NARRATIVE CODE

A code that indicates the reliability, availability, and maintainability (RAM) characteristics narrative.

RAM item function, DED 180	A
RAM maintenance concept, DED 207	B
RAM minimum equipment list narrative, DED 244	C
RAM qualitative and quantitative maintainability requirements, DED 315	D
RAM maintenance plan rationale, DED 210	E

342 RELIABILITY AVAILABILITY MAINTAINABILITY 1 A F -
(RAM) INDICATOR

A code that signifies whether RAM information is to be documented against the LCN item.

RAM Information is documented against the LCN	Y
RAM Information is not documented	blank

343 RELIABILITY CENTERED MAINTENANCE 65 X - -
AGE EXPLORATION

Narrative information stating or describing that an item needs to be considered for age exploration.

344 RELIABILITY CENTERED MAINTENANCE 25 X AS -
LOGIC RESULTS

MIL-STD-1388-2B
APPENDIX E

This is a 25 block spread format, each logic result will consist of one 1 position block. The results of the decision logic of a reliability centered maintenance (RCM) analysis. Codes will denote a yes or no answer, respectively, to each corresponding question in the RCM logic tree utilized, or a code as specified by the requiring authority.

Yes	Y
No	N
Not Applicable	Blank

345 RELIABILITY CENTERED MAINTENANCE 32 X --
LOGIC UTILIZED

The source document or specification in compliance with which the reliability centered maintenance (RCM) analysis has been conducted (e.g., MIL-STD-2173(AS) and MIL-STD-1843).

346 RELIABILITY CENTERED MAINTENANCE 65 X - -
(RCM) REASONING

A narrative describing the reasoning behind the RCM logic results and disposition choices.

347 RELIABILITY/MAINTAINABILITY 1 A F -
INDICATOR CODE

A code used to indicate whether the reliability and maintainability parameters entered on the card are allocated, predicted, or measured analysis values.

Comparative Analysis	C
Allocated	A
Predicted	P
Measured	M

348 REMAIN-IN-PLACE INDICATOR (RIP) 1 A F -

A single character identifying an item for which an unserviceable unit will be turned-in on an exchange basis after receipt of a serviceable unit. Codes and definitions are as follows:

No remain-in-place authority granted	N
Safety consideration	S
Partial mission capable	P
Maintenance consideration	M
Mobility constrained	V
Has not been screened for RIP worthiness	X
Containerization	C

349 REMARKS REFERENCE CODE 2 X F -

A code used to uniquely identify a specific remark. Once associated with a remark, a code may not be associated with any other remark, regardless of LCN and task code. However, once assigned, the same code

MIL-STD-1388-2B
APPENDIX E

shall be used to identify subsequent occurrences of that remark, regardless of LCN and task code.

350 REPAIR CYCLE TIME 18 N - -

The elapsed time, in days, of the complete repair cycle for a reparable item expected at each maintenance level (for definition of O/M level, see DED 277) and at contractor facility.

a. First Subfield 3 N R -
Repair Cycle Time at Organizational/On Equipment/Unit-Organizational level.

b. Second Subfield 3 N R -
Repair Cycle Time at Intermediate/Direct Support/Afloat/Third Echelon/Off Equipment/Intermediate-Forward level.

c. Third Subfield 3 N R -
Repair Cycle Time at Intermediate/General Support/Ashore/Fourth Echelon/Intermediate-Rear level.

d. Fourth Subfield 3 N R -
Repair Cycle Time at Specialized Repair Activity (SRA).

e. Fifth Subfield 3 N R -
Repair Cycle Time at Depot/Shipyard.

f. Sixth Subfield 3 N R -
Contractor. An expressed period of time measured in days from receipt of a failed item at the contractor's facility until the item is returned to the designated receiving point (e.g. repair cycle time at contractor facility).

Option 1.

a. For O, F, H, and SRA, the elapsed time in days, beginning with the removal and replacement of an item to be repaired below depot level, and ending with the pickup of the serviceable item on the appropriate supply records.

b. For D, the number of days includes the time involved in the following:

(1) Removal and preparation of unserviceable items for shipment to CONUS air terminal or oversea aerial port

(2) Shipment to air terminal/aerial port

MIL-STD-1388-2B
APPENDIX E

(3) Shipment from aerial port of embarkation to CONUS aerial port of disembarkation (oversea activities only). This entry should be weighted if the item is applicable to a variety of activities

(4) Shipment from CONUS air terminal/aerial port to CONUS depot level maintenance activity

(5) Receiving/shop planning/batching

(6) Shop flow-time, including inspection

(7) Packaging

(8) Pickup on accountable records

c. For contractor repairable items, the elapsed time in days from time of receipt of the failed item at the contractor's facility, until the item is returned to the designated receiving point.

Option 2. The elapsed time in days from receipt of a failed item at the maintenance level, until the item is ready for issue as a serviceable item.

351 REPAIR SURVIVAL RATE (RSR) 3 N R -

The percentage of depot repairable assets which, through rework, will be returned to serviceable condition.

352 REPAIR WORK SPACE COST 4 N R 2

The cost in dollars of repair work floor space for a maintenance facility for a specific level of maintenance. It is based on dollars per square foot per month.

353 REPLACED OR SUPERSEDING PROVISIONING LIST ITEM SEQUENCE NUMBER 5 X L -

The Provisioning List Item Sequence Number (PLISN) which is replacing or is being replaced in relationship to another PLISN.

354 REPLACED OR SUPERSEDING PROVISIONING LIST ITEM SEQUENCE NUMBER INDICATOR (RS/IND) 1 A F -

A code to indicate type of data entered in the Replaced or Superseding Provisioning List Item Sequence Number.

Replaced PLISN	R
Superseding PLISN	blank

355 REPLACEMENT TASK DISTRIBUTION 15 N - -

MIL-STD-1388-2B
APPENDIX E

The estimated percentage of the removals and replacements of an item that will be accomplished at each specified maintenance level. For definition of each Operations/Maintenance level, see DED 277.

a. First Subfield 3 N R -

Replacement Task Distribution at Organizational/On Equipment/Unit-Organizational level.

b. Second Subfield 3 N R -

Replacement Task Distribution at Intermediate/Direct Support/Afloat/Third Echelon/Off Equipment/Intermediate-Forward level.

c. Third Subfield 3 N R -

Replacement Task Distribution at Intermediate/General Support/Ashore/Fourth Echelon/Intermediate-Rear level.

d. Fourth Subfield 3 N R -

Replacement Task Distribution at Specialized Repair Activity.

e. Fifth Subfield 3 N R -

Replacement Task Distribution at Depot/Shipyard.

356 REPORTABLE ITEM CONTROL CODE 1 N F -

A single-numeric code assigned by the Government Item Manager to those items for which the field is required to report their asset position.

357 REQUIRED DAYS OF STOCK 3 N R -

The number of days required to operate a maintenance facility at a specific level of maintenance without resupply of resources depleted during daily maintenance.

358 REQUIREMENTS FOR 3 X - -

Indicates a requirement for operations/maintenance facilities, training equipment/SE. Consist of the following subfields:

a. Facilities Requirement Code 1 A F -

A code used to designate the facilities requirement for the performance of subject task.

Facility required	Y
Not required	N

b. Training Equipment Requirement Code 1 A F -

MIL-STD-1388-2B
APPENDIX E

Denotes whether training material is required to prepare the operator or maintenance person to perform a given task.

Required Y
Not required N

c. Tool/Support Equipment Requirements Code 1 A F -

Indicates tool/SE requirements and whether the Tool/SE are common or peculiar.

Peculiar tool/SE S
Common tool/SE C
Both Peculiar/common tool/SE B
Not required N

359 RETAIL STOCKAGE CRITERIA 2 N R -

The number of demands per year required to allow stockage of an item.

360 REVISION 2 A R -

An alphabetic code of one or two positions identifying a revision, such as A, B, ..., ZZ.

FACILITY DRAWING REVISION. The revision number for the facility drawing.

361 REVOLVING ASSETS 4 X F -

The quantity of support equipment end items to be procured to offset the out-of-service requirements of the user's end item due to such factors as planned maintenance and calibration. These "loaner" assets are under custody of the intermediate maintenance department/management level. For example:

No revolving assets required Q000
One revolving asset required Q001

362 SAFETY HAZARD SEVERITY CODE (SHSC) 1 N F -

A one-digit code assigned to each identified failure mode for each item analyzed IAW the loss statements below. These codes are assigned to provide a qualitative measure of the worst potential consequences resulting from design deficiency or item failure. Severity classification categories, which are consistent with MIL-STD-882, are defined as follows:

Category 1, Catastrophic. A failure which may cause death or system loss (i.e., aircraft, tank, missile, ship, etc.). 1

Category 2, Critical. A failure which may cause severe injury, major property damage, or major system damage, which will result in mission loss. 2

MIL-STD-1388-2B
APPENDIX E

	Category 3, Marginal. A failure which may cause minor injury, minor system damage which will result in delay or loss of availability or mission degradation.	3
	Category 4, Minor. A failure not serious enough to cause injury, property damage, or system damage, but which will result in unscheduled maintenance or repair.	4
	RAM SAFETY HAZARD SEVERITY CODE. The specified SHSC used to sum the associated failure mode criticality numbers.	
363	SAFETY LEVEL	2 N R -
	The number of days of stock in addition to operating level to compensate for unexpected demands, repair cycle times, pipeline, and procurement lead time, and unforeseen delays.	
364	SAME AS PROVISIONING LIST ITEM SEQUENCE NUMBER (SAME AS PLISN)	5 X L -
	The PLISN assigned to a reference number and CAGE combination at its first appearance in a provisioning list for a PCCN. This PLISN is entered on each subsequent appearance of the reference number and CAGE combination in the provisioning list.	
365	SCOPE	40 X - -
	A brief description of recommended or required data in question or data item description number.	
	DDCC SCOPE. A short narrative describing the design data category.	
	IRCC SCOPE. A short narrative describing the integrated ILS requirement.	
366	SECTIONALIZATION IDENTIFICATION	2 N R -
	A counter applied to each sectionalized portion of the system/equipment for transportation. The same number may be applied to different LCNs if the LCNs are grouped together for transport. A unique counter is applied against each separately sectionalized grouping of the system/equipment.	
367	SECTIONALIZED ITEM TRANSPORTATION INDICATOR	1 A F -
	A code which identifies whether the item is a sectionalized portion of a transported end item.	
	A sectionalized item for transportation	Y
	Not a sectionalized item for transportation	blank
368	SECTIONALIZED REMARKS	65 X - -

MIL-STD-1388-2B
APPENDIX E

The sectionalization requirements for the system/equipment transporting. Narrative information about whether the item can be sectionalized, folded or reduced for transport, including the following for each component or subassembly.

a. The time required to disassemble at departure site and reassemble at destination site (man-hours and elapsed time).

b. Special equipment or tools required for sectionalization (e.g., cranes, forklifts, wrecker trucks, pallets, nitrogen, calibration equipment, fixtures, etc.).

Note: If a task code is assigned to this operation, then these requirements should be referenced using the appropriate LCN, ALC, and task code.

369 SECURITY CLEARANCE 1 N F -

A single-position code indicating the type of clearance required to access classified information.

Top Secret	1
Secret	2
Confidential	3
Unclassified	4

370 SELF TEST 1 A F -

A single-position code indicating if a support/test equipment or a unit under test can perform upon itself a test or series of tests, which shows whether it is operating within designed limits, and to indicate if the test function is automatic or must be manually induced.

Manually induced	M
Automatic	A
No self test	N

TPI SELF TEST. A code identifying whether the test program instruction has self test capabilities.

371 SENSORS OR TRANSDUCERS 1 A F -

A single-letter code indicating whether the TMDE has permanently installed sensors or transducers.

Sensors installed	Y
No sensors	N

372 SEQUENTIAL SUBTASK DESCRIPTION 65 X - -

A narrative description of the complete effort expended to accomplish a specific operational or maintenance subtask. The following taxonomy will be used to inventory and analyze tasks:

MIL-STD-1388-2B
APPENDIX E

a. Job: See DED 185 for definition.

b. Duty: See DED 090 for definition.

c. Task: A composite of related activities (perceptions, decisions, and responses) performed for an immediate purpose, written in operator/ maintainer language (e.g., change a tire).

d. Subtask: Activities (perceptions, decisions, and responses) which fulfill a portion of the immediate purpose within a task (e. g., remove lug nuts).

e. Task Element: The smallest logically and reasonably definable unit of behavior required in completing a task or subtask (e.g., apply counterclockwise torque to the lug nuts with a lug wrench).

373 SERIAL NUMBER 20 X - -

A two-part sequence identifying the range of serial numbers of a specific model of end item or basic system. Consists of the following subfields:

a. From 10 X L -

The beginning serial number in the range of serial numbers defined for the end item or basic system.

b. To 10 X L -

The ending serial number in the range of serial numbers defined for the end item or basic system.

S/N SERIAL NUMBER FROM, S/N SERIAL NUMBER TO. The serial number of the item under analysis having a serial number relationship.

S/N PROVISIONING SERIAL NUMBER FROM, S/N PROVISIONING SERIAL NUMBER TO. The serial number of the provisioned item under analysis having a serial number relationship.

374 SERIAL NUMBER EFFECTIVITY 20 X - -

A two-part sequence identifying the range of serial numbers of a specific group of end items or basic systems to which the item applies. Consists of the following subfields:

a. From 10 X L -

The beginning serial number in the range of serial numbers defined by Serial Number Effectivity.

b. To 10 X L -

The ending serial number in the range of serial numbers defined by Serial Number Effectivity.

MIL-STD-1388-2B
APPENDIX E

375 SERIAL NUMBER USABLE ON CODE

3 A L -

Codes will be assigned in sequence A-Z, then AA-ZZ, followed by AAA-ZZZ (less Is and Os). A blank UOC indicates full effectivity/applicability. A statement shall be attached to the provisioning list defining UOC usage. An example of the use of this option is as follows:

<u>Model</u> <u>Designator</u>	<u>UOC</u>	<u>Serial Number</u>
J-100-54	A	56251-56300
J-100-54	B	56301-56500
J-100-54	C	56501-56750
J-100-54	D	56751, 56755, 57801, 57802
J-100-54	E	56752, 56790, 57000
-----	etc. -----	
J-100-60	Z	59251-59500
J-100-65	AA	57501-57800
J-100-65	AB	57901-58000
-----	etc. -----	
J-100-95	BZ	59501-59575
J-100-95	CA	59501-59575

376 SERVICE DESIGNATOR CODE (SER)

1 A F -

A single-position code identifying the military service or nonmilitary major governmental agency having jurisdiction over, or executive management responsibility for, the acquisition.

Army	A
Air Force	F
Coast Guard	Y
Federal Aviation Administration (FAA)	T
National Security Agency	S
Navy	N
Marine Corps	M
All military	X
FAA/all military	J
Other	O

MODELING SERVICE DESIGNATOR. A service designator code associated with modeling information.

MIL-STD-1388-2B
APPENDIX E

SE SERVICE DESIGNATOR. A service designator responsible for the SE under analysis.

USING SERVICE DESIGNATOR CODE. Multiple service designators which are users of the support equipment under analysis.

377 SHELF LIFE (SL) 1 X F -

A code assigned to an item to indicate a storage or shelf-life time period for an item possessing deteriorative or unstable characteristics (see DOD 4100.38-M for applicable codes).

378 SHELF LIFE ACTION CODE (SLAC) 2 X F -

A two-position code assigned to a shelf life item to specify the type of inspection, test, or restorative action to be taken when the item has reached its storage shelf life, and to specify the extension of the shelf life time period after the test/restorative action has been completed.

Check/inspect/test IAW inventory manager`s instructions. CO

Incorporate all mandatory changes. If found satisfactory, extend the previously established shelf life by an appropriate time period. The first position will always be "C". The second position, shown by a dash (-), will be filled in with a shelf life code from DOD 4100.38-M. This code will be used to indicate the time period that the shelf life may be extended after incorporation of the changes. C-

Incorporate all mandatory changes, perform minor adjustment required, clean and relubricate bearings, reassemble, test to post overhaul standards, and correct any observed discrepancies. Items which pass tests shall be returned to stock as RFI (Ready For Issue). Exterior package marking of such items shall indicate the latest check and test date and the original date of manufacture. Items which fail test shall be placed in "F" condition. CT

To be tested by the laboratory/activity after the initial shelf life has expired and at specified time intervals thereafter. The first position will always be "L". The second position, shown by a dash(-), will be filled in with a shelf life code from DOD 4100.38-M. This code will be used to indicate the time period at which samples should be periodically submitted to the laboratory/activity for testing L-

MIL-STD-1388-2B
APPENDIX E

after the initial shelf life has expired. If item fails test, take disposal action.

Replace all deteriorated and nonmetallic components subject to deterioration (disassemble and process to the level required to permit replacement of deteriorable items; test to post-overhaul standards and return to stock as RFI item with fully restored storage time limitations). Exterior package marking of such items shall indicate the latest date of overhaul. RD

Provides for equipment that has been tested with fluids indicated by Specification MIL-F-7024 and has not subsequently been operated with other fluids. (Use for fuel metering equipment only.) RN

This is assigned to fuel metering equipment, which has been tested by other than MIL-F-7024. RJ

Salvage SA

Request cannibalization/salvage instructions from inventory manager. SB

Identification of Safety Items. A safety item designated by the requiring authority that is subject to a 5 year age limitation when used for purposes involving safety of personnel. Material in this category that is over 5 years old will not be used for repair or modification of personnel, drag, or special parachutes, or others used directly involving personnel safety. Use advice code 2H unless material is being used for cargo parachutes, or other uses not involving personnel safety. S9

Test, if OK, extend previously established shelf life by an appropriate time period and process IAW with code RD. The first position will always be "T". The second position, shown by a dash (-), will be filled in with a shelf life code from DOD 4100.38-M. This code will be used to indicate the time period that the shelf life may be extended after passing test and processing IAW code RD. T-
NOTE: For flight clothing, the second position of the code will be used to indicate the time interval at which periodic testing should be performed. If OK, return to stock as an RFI item; if not OK, make necessary repairs

MIL-STD-1388-2B
APPENDIX E

to the extent economically feasible and return to stock as RFI item.

Unsuitable for restoration to issuable status. At end of shelf life period, material will be disposed of IAW existing instructions. UU

Test. If item passes a test, extend the previously established shelf life by an appropriate time period. The first position will always be "X". The second position, shown by a dash (-), will be filled in with a shelf life code from DOD 4100.38-M. This code will be used to indicate the time period that the shelf life may be extended. If item fails tests, dispose of it IAW existing instructions. X-

Non-deteriorative. When the shelf life is coded 0, then the shelf life action code of 00 is mandatory. 00

379 SHIP TIME 3 N R -

The number of days from the time a requisition for a spare/repair part is placed with the supply system until the item is received at the maintenance shop.

380 SHIPPING CONFIGURATION 2 A L -

A code that identifies the shipping configuration of the item being reported. A complete listing of the codes may be found in DOD-4500.32-R, volume I, chapter 7. Frequently used codes are as follows:

Carboy	CB
Container, MAC ISO lightweight 8 x 8 x 20 ft. air	CM
Can	CN
Crate	CR
Case	CS
Carton	CT
Container, Navy cargo transporter	CU
Cylinder	CY
Drum	DR
Engine container	EC
Engine cradle or dolly	ED
Keg	KE
Loose, not packaged	LS
Multi-walled container secured to a warehouse pallet	MW
Mixed (more than one type of shipping container)	MX
Palletized unit load, other than code MW	PT
Reel	RL
Toll on, roll off	RT
Skid, box	SB
Skid	SD
Vehicle	VE
Vehicle in operating condition	VO

MIL-STD-1388-2B
APPENDIX E

381 SHIPPING WEIGHT (EMPTY/LOADED) 4 N R 1

The shipping weight in tons of the system/equipment being transported.

382 SHOCK AND VIBRATION REMARKS 65 X L -

A narrative stating the fragility, shock, and vibration considerations required for the system/equipment under analysis (e.g., MIL-STD-810 rail impact test, drop test).

383 SKETCH 1 A F -

Indicates whether a sketch or line art drawing accompanies the SERD product to clarify descriptive.

"Y" for yes
"N" for no

384 SKID AREA 6 N R 1

A numeric value describing the size of the skid of the transported item in units contained in the associated UM.

385 SKID REMARKS 65 X - -

A narrative description pertaining to skid(s) and skid areas for the item under analysis being transported.

386 SKILL LEVEL CODE 1 A F -

A single-position code indicating the skill level of a given SSC.

Basic	Applies to the qualifications of personnel of pay grades E-4 and below.	B
Intermediate	Applies to the qualifications of personnel pay grade E-5.	I
Advanced	Applies to the qualifications of personnel of pay grades E6 and above.	A

NEW OR MODIFIED SKILL LEVEL CODE. The skill level code of the new or modified SSC.

387 SKILL SPECIALTY CODE (SSC) 7 X L -

Describes the maintenance or operator skill required to accomplish the task. Codes are specified in publications listed below:

ARMY NAVY AIR FORCE MARINE CORPS

MIL-STD-1388-2B
APPENDIX E

Officer	AR 611-101	NAVPERS 15839	AFR 36-1	MCO P 1200.7
Warrant Officer	AR 611-112	NAVPERS 15839	- - -	MCO P 1200.7
Enlisted	AR 611-201	NAVPERS 18068D	AFR 39-1	MCO P 1200.7
Civilian:	DA CPR 502, AFR 36-1, AFR 39-1 FPM Supplement 512-1, Civil Service Commission, Job Grading Standard			

SKILL SPECIALTY CODE FOR SUPPORT EQUIPMENT OPERATOR. The SSC required to operate the SE under analysis.

388 SKILL SPECIALTY EVALUATION CODE 1 A F -

A single-position code denoting the adequacy of the identified SSC with regard to the specific skills and knowledge required to accomplish the identical task. Used as a flag to indicate the requirement for additional training.

SSC is adequate	A
SSC needs modification (additional training)	M
New SSC should be established	E

389 SOURCE, MAINTENANCE AND RECOVERABILITY CODE (SMR) 6 X L -

SMR codes are a series of alpha or alphanumeric symbols used at the time of provisioning to indicate the source of supply of an item, its maintenance implications, and recoverability characteristics. The provisioning activity may require the contractor to recommend these codes.

a. Source Codes. These codes are assigned to support items to indicate the manner of acquiring support items for maintenance, repair, or overhaul of end items. Source codes are entered in the first and second position of the Uniform SMR Code. Applicable codes are as follows:

<u>Definition</u>	<u>Code</u>
Item procured and stocked for anticipated or known usage.	PA
Item procured and stocked for insurance purposes because essentiality dictates that a minimum quantity be available in the supply systems.	PB
Item procured and stocked and which otherwise would be coded PA except that it is deteriorative in nature.	PC
Support item, excluding support equipment,	PD

MIL-STD-1388-2B
APPENDIX E

procured for initial issue or outfitting and stocked only for subsequent or additional initial issues or outfittings. Not subject to automatic replenishment.	
Support equipment procured and stocked for initial issue or outfitting to specified maintenance repair activities.	PE
Support equipment which will not be stocked but which will be centrally procured on demand.	PF
Item procured and stocked to provide for sustained support for the life of the equipment. It is applied to an item peculiar to the equipment which because of probable discontinuance or shutdown of production facilities would prove uneconomical to reproduce at a later time.	PG
An item of depot overhaul/repair kit and not purchased separately. Depot kit defined as a kit that provides items required at the time of overhaul or repair.	KD
An item of a maintenance kit and not purchased separately. Maintenance kit defined as a kit that provides an item that can be replaced at organizational or intermediate levels of maintenance.	KF
Item included in both a depot overhaul/repair kit and a maintenance kit.	KB
Item to be manufactured or fabricated at organizational level.	MO
Item to be manufactured or fabricated at intermediate maintenance levels. Air Force-Intermediate(*) Marine Corps-3rd Echelon Army-Direct Support(*) Navy-Afloat	MF
Item to be manufactured or fabricated at intermediate maintenance levels. Air Force-Intermediate(*) Marine Corps-4th Echelon Army-General Support(*) Navy-Ashore	MH
Item to be manufactured or fabricated at both afloat and ashore intermediate maintenance levels-Navy use only.	MG
Item to be manufactured or fabricated at depot maintenance level.	MD
Item to be assembled at organizational level.	AO

MIL-STD-1388-2B
APPENDIX E

Item to be assembled at intermediate maintenance levels.	AF
Air Force-Intermediate(*)	Marine Corps-3rd Echelon
Army-Direct Support(*)	Navy-Afloat
Item to be assembled at intermediate maintenance levels.	AH
Air Force-Intermediate(*)	Marine Corps-4th Echelon
Army-General Support(*)	Navy-Ashore
Item to be assembled at both afloat and ashore intermediate maintenance level-Navy use only.	AG
Item to be assembled at depot maintenance levels	AD
Item is not procured or stocked because the requirements for the item will result in the replacement of the next higher assembly.	XA
Item is not procured or stocked. If not available through salvage, requisition.	XB
Installation drawing, diagram, instruction sheet, field service drawing, that is identified by manufacturer's part number.	XC

(*) NOTE: For USAF and the USA Safeguard Program, only Code "F" will be used to denote intermediate maintenance. On joint programs, use either codes "F" or "H" by the joining service will denote intermediate maintenance to USAF and the USA Safeguard Program.

b. Maintenance codes. These codes are assigned to indicate the levels of maintenance authorized to USE and REPAIR support items. The maintenance codes are entered in the third and fourth position of the Uniform SMR Code. Applicable codes are as follows:

USE (Third Position): The maintenance code entered in the third position will indicate the LOWEST maintenance level authorized to remove, replace, and use the support item. The decision to code the item for removal and replacement at the indicated maintenance level will require that all capabilities necessary to install and ensure proper operation after installation of a replacement item (i.e., preinstallation inspection, testing, and post-installation checkout) are provided. The maintenance code, entered in the third position, will indicate one of the following levels of maintenance.

<u>Application/Explanation</u>	<u>Code</u>
Support item is removed, replaced, used at the organizational level of maintenance.	O

Note (1): To distinguish between the organizational maintenance capabilities on different classes of ships, the following codes may be used intra-Navy

MIL-STD-1388-2B
APPENDIX E

only. On joint programs, Navy will receive and transmit an O to indicate organizational maintenance level.

2-Minesweeper, Yardcraft, Patrol Boat

3-Submarines

4-Auxiliary/Amphibious Ships

5-Major Combatant (Destroyer, Frigate)

6-Major Combatant (Cruiser, Carrier)

Note (2): On Army programs, a code of "C" may be used in the third position to denote crew or operator maintenance performed within organizational maintenance. On joint programs, the Army will receive or transmit an O to indicate organizational level.

Support item is removed, replaced, used at the following intermediate levels. F

USAF-Intermediate (*)

USA-Direct Support (*)

USN-Afloat

USMC-Third Echelon

Support item is removed, replaced, used at both afloat and ashore intermediate levels: G

Navy only

Support item is removed, replaced, used at the following intermediate levels: H

USAF-Intermediate (*)

USA-General Support (*)

USN-Ashore (only)

USMC-Fourth Echelon

* Note: For the USAF program and USA safeguard program, Code F will be used to denote intermediate maintenance. On joint programs, use of either Codes F or H by the joining service will denote intermediate maintenance to USAF and the USA Safeguard program.

Support Items that are removed, replaced, used at Depot only: D

USAF-Depot, Mobile Depot, and Specialized Repair Activity

USA-Depot, Mobile Depot, Specialized Repair Activity

USN-Aviation Rework, Avionics and Ordnance Facilities, Shipyards

USMC-Depot

REPAIR (Fourth Position): The maintenance code entered in the fourth position indicates whether the item is to be repaired and identifies the lowest maintenance level with the capability to perform complete repair (i.e., all authorized maintenance functions). The decision to code the support item for repair at the indicated maintenance levels requires that

MIL-STD-1388-2B
APPENDIX E

all maintenance capability (remove, replace, repair, assemble, and test) for the support items be provided to that level. This does not preclude some repair which may be accomplished at a lower level of maintenance. However, because of service differences in communicating maintenance repair level information, a maintenance code entry in this position is not required by all services. When a maintenance code is not used, a dash (-) sign will be entered. For multi-service equipment/systems, or when a code is entered, this position will contain one of the following maintenance codes as assigned by the service(s) that require the code:

<u>Application/Explanation</u>	<u>Code</u>
The lowest maintenance level capable of complete repair of the support item is the organizational level.	0

Note: To distinguish between the organizational maintenance capabilities on different classes of ships, the following codes may be used intra-Navy only. On joint programs, Navy will receive and transmit an 0 to indicate organizational maintenance level.

- 2-Minesweeper, Yardcraft, Patrol Boat
- 3-Submarines
- 4-Auxiliary/Amphibious Ships
- 5-Major Combatant (Destroyer, Frigate)
- 6-Major Combatant (Cruiser, Carrier)

The lowest maintenance level capable of complete repair of the support item is the following intermediate level: USAF-Intermediate (*) USA-Direct Support (*) USN-Afloat USMC-Third Echelon	F
---	---

The lowest maintenance level capable of complete repair of the support item is the following intermediate level: USAF-Intermediate (*) USA-General Support (*) USN-Ashore (Only) USMC-Fourth Echelon	H
--	---

* Note: For USAF program and the USA safeguard program, Code F will be used to denote intermediate maintenance. On joint programs, use of either Codes F or H by the joining service will denote intermediate maintenance to USAF and the USA Safeguard program.

Both afloat and ashore intermediate levels are capable of complete repair of support item: Navy only.	G
---	---

MIL-STD-1388-2B
APPENDIX E

The lowest maintenance level capable of complete repair of the support item is the depot level: USAF-Depot, Mobile Depot, and Specialized Repair Activity USA-Depot, Mobile Depot, Specialized Repair Activity USN-Aviation Rework, Avionics, and Ordnance Facilities, Shipyards USMC-Depot	D
Repair restricted to designated Specialized Repair Activity.	L
Nonreparable. No repair is authorized.	Z
No repair is authorized. The item may be reconditioned by adjusting, lubricating, etc., at the user level. No parts or special tools are procured for the maintenance of this item.	B

c. Recoverability Codes. These codes are assigned to support items to indicate the disposition action on unserviceable items. The recoverability code is entered in the fifth position of the Uniform SMR Code. Applicable codes are as follows:

<u>Definition</u>	<u>Code</u>
Nonreparable item. When unserviceable, condemn and dispose at the level indicated in column 3.	Z
Reparable item. When uneconomically repairable, Condemn and dispose at organizational level.	O
Reparable item. When uneconomically repairable, condemn and dispose at the following intermediate levels: USAF-Intermediate (*) USA-Direct Support (*) USN-Afloat USMC-Third Echelon	F
Reparable item. When uneconomically repairable, condemn and dispose at the following intermediate levels: USAF-Intermediate (*) USA-General Support (*) USN-Ashore USMC-Forth Echelon	H

* Note: For USAF program and the USA safeguard program, Code F will be used to denote intermediate maintenance. On joint programs, use of either Codes F or H by the joining service will denote intermediate maintenance to USAF and the USA Safeguard program.

MIL-STD-1388-2B
APPENDIX E

Reparable item. When beyond lower-level repair capability, return to depot. Condemnation and disposal not authorized below depot level. D

Reparable item. Repair, condemnation, and disposal not authorized below depot/Specialized Repair Activity level. L

Item requires special handling or condemnation procedures because of specific reasons (i.e., precious metal content, high-dollar value, critical material, or hazardous material). Refer to appropriate manuals/directives for specific instructions. A

d. Service Peculiar Codes. These codes are peculiar to each service/program and are assigned accordingly. These codes are entered in the sixth position of the Uniform SMR Code.

SE SOURCE, MAINTENANCE AND RECOVERABILITY CODE. The SMR of the support equipment under analysis.

390 SPARE FACTOR 4 X F -

A specific quantity or percentage developed to guide the government's determination of requirements (procurement of end items over and above operational quantities) to provide replacement for an item(s) subject to damage, survey/disposal. An example follows:

A specific quantity	QXXX
Percentage of operational assets	PXXX
quantity (for consumables only)	
No spares required	Q000

391 SPARES ACQUISITION INTEGRATED WITH PRODUCTION (SAIP) 1 A F -

MIL-STD-1388-2B
APPENDIX E

An alphabetic code indicating that the item is a candidate for an SAIP list.

Item is an SAIP list candidate Y
Item is not an SAIP list candidate blank

392 SPECIAL MAINTENANCE ITEM CODE (SMIC) 1 A F -

A code which indicates any special maintenance category applicable to the line item. Codes assigned are as follows:

Nonrepairable A

Factory repairable B

Matched set C

Select at test D

MAMS (Maintenance Assistance Modules). An item authorized or recommended by the government/contractor for procurement and location with the end item as the sole means of fault isolation in the event of failure. Contractor recommendations shall be IAW the maintenance philosophy approved by the government. (e.g., modules employed in diagnostic circuitry used for "built-in" fault isolation). F

Remain in Place. A repairable item which, upon removal without an immediate replacement, would: a. Destroy structural integrity; b. Endanger operating or maintenance personnel; or, c. If partially degraded, cause total degradation of an essential function of the end item. G

Safety. An item which, upon failure, would jeopardize the direct safety of operating or maintenance personnel. H

393 SPECIAL MANAGEMENT 1 A F -

A code to flag an SE end item for special management attention. Codes are as follows:

<u>Management Concern</u>	<u>Code</u>	<u>Criteria</u>
Time	T	SE end item will not be available concurrently with end article, SE ILS, or the development lead time is excessive.
Price	P	SERD identified development prices or recurring unit price are sub-

MIL-STD-1388-2B
APPENDIX E

			stantially above the average SE end item.
	State of the art	A	SE end item is state-of-the-art and required the development of an end item specification/ requires reliability qualification.
	Safety	S	SE end item is proposed to correct a safety defect.
	Mission essentiality	M	SE end item is essential to conduct of the end article's mission.
		N	Not applicable
394	SPECIAL MARKING CODE		2 X F -
	A code which identifies special markings which are required as an integral part of the total pack to protect the contained item during preservation, packing, storage, transit, and removal from the pack. For applicable codes, see MIL-STD-2073-1 and MIL-STD-2073-2.		
395	SPECIAL MATERIAL CONTENT CODE (SMCC)		1 X F -
	A code indicating that an item represents or contains peculiar material requiring special treatment, precautions, or management control of the item (see DOD 4100.38-M for applicable codes).		
396	SPECIAL PACKAGING INSTRUCTION NUMBER		10 X L -
	A number which identifies a specific special packaging instruction prepared IAW MIL-STD-2073-1 and MIL-STD-2073-2.		
397	SPECIAL PACKAGING INSTRUCTION (SPI) NUMBER REVISION		1 A F -
	A code which identifies the SPI revision.		
	Codes		A through Z
398	SPECIALIZED SERVICE AND EQUIPMENT REQUIREMENTS		65 X - -
	Narrative information concerning the requirements for special rail cars, highway vehicles, or material handling equipment such as spreader bars or slings.		
399	SPECIFIC AUTHORIZATION		71 X - -
	Identifies the type of activity, number of type activities, and the quantity of support/test equipment or training material which is to be		

MIL-STD-1388-2B
APPENDIX E

supported at each activity. Unless otherwise advised by the requiring authority, the support period shall be for one year beginning with the scheduled delivery of the first end item. This shall be confirmed or changed by the government. Consists of the following subfields:

a. Number of activities 3 N R -

The specific number of activities of a type (e.g., 6 depots, 2 squadrons).

b. Type of activity 15 X L -

The activities by type. Examples of these activities are: training, specialized repair activity, depot, etc., including preoperational activities whose allowances are not derived from the Basis of Issue.

c. Name/location of activity 50 X L -

The name and location of the activity to be allocated support equipment to include the activity address indicator.

d. Quantity per activity 3 N R -

The quantity of support/test equipment or training materiel to be provided to each activity.

400 SPEED 3 N R -

The maximum speed of the system/equipment in miles per hour.

401 STANDARD INTERSERVICE AGENCY SERIAL CONTROL NUMBER (SIASCN) 7 X F -

A seven-position alphanumeric code assigned to executive service managed items in support of provisioning of multiservice systems and equipment. The SIASCN is assigned to all items which require NSN assignment/supported service(s) user registration. The SIASCN is composed of a specific alphabetic prefix designating the executive service Inventory Control Point (ICP) followed by six numeric characters as specified by the requiring authority. Alphabetic prefixes have been assigned to specific ICPs as follows:

Service/Agency	ICP Managing Activity	Prefix
Marine Corps	Marine Corps Logistics Base, Albany, GA	A
U.S. Air Force	Sacramento ALC, CA	B
	Warner Robins ALC, Robins AFB, GA	C
	San Antonio ALC, Kelly AFB, TX	D
	Ogden ALC, Hill AFB, UT	E
	Oklahoma City ALC, Tinker AFB, OK	F
	AF Cryptologic Support Center (ESC), San Antonio, TX	J

MIL-STD-1388-2B
APPENDIX E

Army	Communications and Electronics Materiel Readiness Command, Ft. Monmouth, NJ	G
	Tank Automotive Command, Warren, MI	K
	Missile Command, Redstone Arsenal, AL	L
	Armament, Munitions, and Chemical Command, Rock Island, IL	M
	Troop Support Command, St. Louis, MO	N
	Aviation Systems Command, St. Louis, MO	Q
	Electronic Material Readiness Activity, Warrenton, VA	P
	Communications Security Logistics Activity, Ft. Huachuca, AZ	U
Navy	Ships Parts Control Center, Mechanicsburg, PA	H
	Aviation Supply Office, Philadelphia, PA	O
FAA	Mike Monroney Aeronautical Center, Oklahoma City, OK	R
402	STANDARDS FOR COMPARISON	1 A F -
	A single-position code indicating a standard was identified against which the support/test equipment was compared for testing of the UUT.	
	Standard identified	Y
	Standard not identified	N
403	STANDBY TIME	4 N R -
	The time, in hours per calendar year, that a system/equipment is not operating, but is assumed to be operable.	
	REQUIRED STANDBY TIME. The standby time representing the supportability requirement/specification standby time.	
404	STATUS	1 A F -
	A one-position alphabetic code to describe the status of the dispositioning action applied to the SERD. Codes are as follows:	
	Approved	A
	Deleted	D
	Pending further information from the contractor	C
	Pending further government evaluation	G
	Contractor recommended	R
	SERD will be approved when funding is available	U
	Disapproved	X
405	STORAGE DIMENSIONS	12 N - AS
	Dimensions of an item of support/test equipment or training material while it is in the storage configuration mode. Consists of the following subfields:	

MIL-STD-1388-2B
APPENDIX E

	a. Length	4 N R 1
	b. Width	4 N R 1
	c. Height	4 N R 1
406	STORAGE WEIGHT	6 N R 1
	The weight of an item of support/test equipment or training material while it is in the storage configuration mode.	
407	SUBTASK NUMBER	3 N F -
	A three-position code to indicate sequence of the procedural step as a subtask. Subtask numbers shall begin with 001 through 999, and are assigned to each sequential subtask required to perform a given task. A subtask is an activity (perception, decisions, and responses) which fulfills a portion of the immediate purpose within a task.	
	REFERENCED SUBTASK NUMBER. A subtask number of referenced subtask narrative.	
408	SUPERSEDURE TYPE	1 A F -
	A code indicating the impact an SERD end item has on other end items. Codes are as follows:	
	SERD item supersedes an existing item	A
	SERD item is replaced by another SERD item	B
	SERD item neither supersedes nor is superseded by another item	C
	SERD item is deleted	D
409	SUPPLEMENTAL PACKAGING DATA	59 X L -
	Concise remarks or statements which are pertinent to the packaging process and are required in addition to that specific data documentation.	
410	SUPPORT CONCEPT	1 A F -
	A code indicating the status of the indepth analysis conducted to determine if Contractor Logistic Support (CLS), Interim Contractor Support (ICS), or Organic Support is the preferred support concept for the item.	
	Item reviewed and nominated by the contractor for ICS	A
	Item approved/selected by the government for ICS	B
	Item reviewed and nominated by the contractor for CLS	C
	Item approved/selected by the government for CLS	D
	Item reviewed and nominated by the contractor for organic support	E
	Item approved/selected by the government for organic support	F
	Item not reviewed	G

MIL-STD-1388-2B
APPENDIX E

411 SUPPORT EQUIPMENT EXPLANATION 65 X - -
Narrative statements used to explain a condition not readily identified in a given data element within the support equipment (E) tables, or a particular element which requires additional comment. When the information is related to a specific data element, the explanation should be prefaced with a reference to that element. Place a "C" or "G" in parenthesis after the entry to indicate the source to contractor or government, respectively.

412 SUPPORT EQUIPMENT FULL ITEM NAME 42 X L -
The name of the support equipment.

413 SUPPORT EQUIPMENT GROUPING 3 N F -
A contractor-assigned number to facilitate the aggregation of requirements for similar or identical support or test equipment types, including automatic test equipment.

414 SUPPORT EQUIPMENT NARRATIVE CODE 1 A F -
A code that indicates the type of support equipment narrative.

Functional analysis (DED 147)	A
Description and function of support equipment (DED 078)	B
Support equipment non-proliferation effort (DED 415)	C
Characteristics of support equipment (DED 044)	D
Installation factors or other facilities (DED 169)	E
Additional skills and special training requirements (DED 008)	F
Support equipment explanation (DED 411)	G
Justification (DED 188)	H

415 SUPPORT EQUIPMENT NON-PROLIFERATION EFFORT 65 X - -
A brief narrative by the contractor on his efforts to standardize SE/ limit its proliferation by selecting DOD inventory equipment or modifying existing Government or commercial, and shall include a list of documents and databases screened (see MIL-STD-2097, paragraph 5.3.2.1).

416 SUPPORT EQUIPMENT RECOMMENDATION DATA NUMBER (SERD NUMBER) 10 X - -
A 10-position code assigned to each item of support equipment having a unique Reference Number and Commercial and Government Entity (CAGE) Code. It consists of the following subfields:

a. System/Subsystem/Sub-subsystem Code. 6 X F -

The first six-positions of the SERD Number comprise this subfield and identify support equipment to the system/subsystem/sub-subsystem which the support equipment supports. This code will be based on a combination

MIL-STD-1388-2B
APPENDIX E

of characters from MIL-M-83495, Preparation of Manuals, Technical, Organizational Maintenance Manual Set.

b. Sequence Number 4 N F -

The last four digits of the 10-position SERD number indicates the number assigned sequentially to each unique SE item which is proposed for the system, subsystem, or sub-subsystem. Sequence numbers shall begin with 0001 and run through 9999.

AID SUPPORT EQUIPMENT RECOMMENDATION DATA NUMBER. The SERD number of the adapter interconnector device.

OTP SUPPORT EQUIPMENT RECOMMENDATION DATA NUMBER. The SERD number of the operational test program.

TPI SUPPORT EQUIPMENT RECOMMENDATION DATA NUMBER. The SERD number of the test program instruction.

417 SUPPORT EQUIPMENT RECOMMENDATION DATA REVISION REMARKS 65 X - -

If the support equipment recommendation data (SERD) being prepared is a revision, enter the revision letter, revision date, action date (G), and revision remarks which summarize the reason for revision. For SERDs that have been revised more than once, this block shall include the revision date and revision remarks of all previous revisions.

418 SUPPORT EQUIPMENT REQUIRED 1 A F -

A single-letter code indicating whether the support/test equipment or training material itself needs SE to test or maintain its operational capability.

SE Y
Not required N

419 SUPPORT EQUIPMENT SHIPPING DIMENSIONS 12 N - AS

The dimensions of an item of support/test equipment as it is configured for shipment. Consists of the following subfields:

a. Length 4 N R 1

b. Width 4 N R 1

c. Height 4 N R 1

420 SUPPORT EQUIPMENT SHIPPING WEIGHT 6 N R 1

The weight of an item of support/test equipment as configured for shipment.

421 SUPPORT OF SUPPORT EQUIPMENT COST FACTOR 3 N R 2

MIL-STD-1388-2B
APPENDIX E

A decimal value which expresses the cost factor for supporting SE. This factor is derived from the ratio of the yearly SE costs to the SE unit costs.

422 SUPPRESSION INDICATOR CODE 1 A F -

A code to indicate the item is to be provisioned separately by either a separate PCCN, or under a different time schedule than the overall provisioning.

Provisioned separately Y

423 SYSTEM/END ITEM IDENTIFIER 1 A F -

A code that signifies whether the LCN represents a system, end item, or not a system/end item. A system or end item is an item capable of independent operation, or is a class or group of equipments that is managed and provisioned under a separate Provisioning Contract Control Number.

System S
End Item E
Not a system/end item N

PROVISIONING SYSTEM/END ITEM IDENTIFIER. An identifier for the system/end item being provisioned.

424 SYSTEM/END ITEM NARRATIVE CODE 1 A F -

A code that indicates the system/end item narrative.

Additional supportability parameters A
Additional supportability considerations B
Operational mission failure definition C

425 SYSTEM REDESIGN/LOGISTICS CONSIDERATIONS CODE 1 X F -

A one-position code indicating whether the information is related to system redesign or logistics considerations narrative. Codes are as follows:

System redesign (standardization) A
System redesign (accessibility) B
System redesign (maintenance ease) C
System redesign (safety) D
System redesign (test points) E
System redesign (skills) F
System redesign (training) G
System redesign (connectors for ease of removal) H
System redesign (packaging and transportation) J
System redesign (fault location) K
System redesign (labeling) L
System redesign (design for self protection against) M

MIL-STD-1388-2B
APPENDIX E

damage after failure)	
System redesign (corrosion and rust control)	N
Narrative (standardization)	P
Narrative (accessibility)	Q
Narrative (maintenance ease)	R
Narrative (safety)	S
Narrative (test points)	T
Narrative (skills)	U
Narrative (training)	V
Narrative (connectors for ease of removal)	W
Narrative (packaging and transportation)	X
Narrative (fault location)	Y
Narrative (labeling)	Z
Narrative (design for self protection against damage after failure)	1
Narrative (corrosion and rust control)	2

426 SYSTEM REDESIGN/LOGISTICS 65 X - -
CONSIDERATION RECOMMENDATION,
DISPOSITION, RESULTS

A narrative of either system or reliability centered maintenance (RCM) redesign considerations.

System Redesign. A narrative description identifying recommended design changes, disposition of each recommendation, and the results of each recommendation for which analysis indicates a redesign might be warranted. Shall include appropriate feasibility and cost benefit analysis results performed to validate the redesign recommendations.

RCM Redesign. A narrative description identifying recommended design changes, that come from the RCM analysis, the disposition of each recommendation and results of each recommendation for which analysis indicates a redesign might be warranted. Shall include appropriate feasibility and cost benefit analysis results performed to validate the redesign recommendations.

427 TASK CODE 7 X F -

A data chain of six separate data subfields which uniquely identify each operator/maintenance task associated with particular items under analysis. The first five subfields provide information relative to the performance of the task itself. The sixth subfield is a task sequence code provided to differentiate tasks with identical entries in the first five subfields. The individual subfields that comprise the task code are described as follows:

a. Task Code (FUNCTION) 1 X F -

A code that denotes specific maintenance, operator, or supporting functions necessary to the operation and maintenance of an item.

MIL-STD-1388-2B
APPENDIX E

<u>Access</u> . To perform operations necessary to gain access to an item of the next lower level of indenture or an item blocking accessibility to the item under analysis.	
Access	W
<u>Adjust</u> . To maintain or regulate, within prescribed limits, by bringing into proper or exact position, or by setting the operating characteristics to specified parameters.	
Adjust	D
<u>Align</u> . To adjust specified variable elements of an item to bring about optimum or desired performance.	
Align	E
<u>Calibrate (CAL)</u> . To determine accuracy, deviation or variation by special measurement or by comparison with a standard.	
Calibrate	F
<u>Camouflage</u> . To conceal or disguise.	
Camouflage	9
<u>Clean</u> . To rid of dirt, impurities or extraneous matter from the item.	
Clean	Q
<u>Debug</u> . To detect and remedy an inadequacy in software.	
Debug	2
<u>Disassemble/Assemble</u> . To take to pieces; to take apart to the level of the next smaller unit, or down to all removable parts.	
Disassemble/Assemble	S
<u>Dispose</u> . To get rid of including those actions to prepare an item for disposal, e.g., demilitarization.	
Dispose	3
<u>End of Runway Inspection</u> . The inspection which is a visual/operational check of designated systems and components performed at end of runway.	
End-of-Runway Inspection	Z
<u>Evaluate</u> . To determine the importance, size or nature of; to appraise; to give value or appraisal to on the basis of collected data.	
Evaluate	8

MIL-STD-1388-2B
APPENDIX E

Fault Location (FAULT LOCAT). The process of investigating and detecting the cause of equipment malfunctioning; the act of isolating a fault within a system or Unit Under Test.

Fault Location N

Inspect. To determine the serviceability or detect incipient failures by comparing an item's physical, mechanical, and/or electrical characteristics with established standards through examination (e.g., by sight, sound, or feel).

Inspect A

Install. To perform operations necessary to properly fit a spare part into the next higher assembly.

Install G

Load/Unload. To place or insert in or take out of, a device or piece of equipment; to place or remove or components on an airplane or other vehicle.

Load/Unload 4

Lubricate. To apply a substance (e.g., oil, grease, graphite) to reduce friction.

Lubricate P

Mission Profile Change. The function performed to enable the end item to perform a different type mission.

Mission Profile Change M

Monitor. To attend to displays continually or periodically to determine equipment condition or operating status.

Monitor 6

Operate. To control equipment in order to accomplish a specific purpose.

Operate O

Overhaul. That maintenance effort (service/action) prescribed to restore an item to completely serviceable/operational condition as required by maintenance standards in appropriate technical publications. Overhaul is normally the highest degree of maintenance performed.

Overhaul K

Package/Unpackage. The action required to prepare system and equipment for storage and transportation. Also includes the action required to unpack.

MIL-STD-1388-2B
APPENDIX E

Package/Unpackage

U

Preserve. The action required to treat systems and equipment whether in stalled or stored, to keep them in a satisfactory condition.

Preserve

V

Process. To submit to a series of actions or operations leading to a particular end.

Process

7

Rebuild. Consists of those services/actions necessary for the restoration of unserviceable equipment to a like-new condition in accordance with original manufacturing standards. Rebuild is the highest degree of materiel maintenance applied to equipment. The rebuild operation includes the act of returning to zero those age measurements (hours/miles, etc.) considered in classifying equipments/components.

Rebuild

L

Remove. To perform operations necessary to take a spare part out of the next larger assembly.

Remove

R

Remove and Replace. To substitute a serviceable spare part for a malfunctioned, damaged, or worn-out part. This function should only be used when the item represented by the LCN against which the task is being documented is being replaced. Remove and Replace actions will include discrete sequences for fault location, correction of the fault or malfunction by removal of the item and replacing it with a spare, and verification that the fault has been corrected. The fault location and verification may be documented one indenture above the Remove and Replace action.

Remove and Replace

H

Repair. Utilized as a corrective maintenance action or task function to restore to a serviceable condition an end item, assembly, subassembly, module, or component. Also to be utilized as maintenance action or task function to restore an item removed from the end item through replacement of lower-order nonrepairable items and through rework such as patching, welding, grinding, straightening, facing, machining, or resurfacing to correct a specific fault. Repair actions will include discrete sequences for fault location, correction of the fault or malfunction, and verification that the fault has been corrected.

Repair

J

Service. Operations required periodically to keep an item in proper operating condition, i.e., to clean (includes decontaminate, when required), to preserve, to drain, to paint, or to replenish fuel, lubricants, chemical fluids, or gases.

MIL-STD-1388-2B
APPENDIX E

Service	C
<u>Set Up.</u> To prepare or make an item ready for operation.	
Set up	5
<u>Test.</u> To verify serviceability by measuring the mechanical, pneumatic, hydraulic, or electrical characteristics of an item and comparing those characteristics with prescribed standards.	
Test	B
<u>Transport.</u> The action required to move systems and equipment from one place to another.	
Transport	Y
<u>Transportation Preparation.</u> The actions required to prepare an item for transportation.	
Transportation Preparation	T
b. Task Interval Code (INTERVAL) 1 A F -	
A code that identifies the scheduled or unscheduled timing of the task occurrence.	
<u>Battlefield Damage Assessment and Repair.</u> Occurring on the system/equipment in a battlefield environment as a result of battle damage.	
Battlefield damage assessment and repair	Y
<u>Calendar.</u> Occurring as a period of time equal in length to 365 days.	
Calendar	Q
<u>Daily.</u> Occurring every day; operation of the day.	
Daily	C
<u>During Operation.</u> Occurring during each operation.	
During Operation	D
<u>Emergency.</u> Resulting from an unforeseen combination of circumstances that calls for immediate action to prevent injury to personnel and/or damage to equipment.	
Emergency	J
<u>Monthly.</u> Occurring approximately every 4 weeks or 30 days.	
Monthly	P

MIL-STD-1388-2B
APPENDIX E

Normal. Inspection according with, or not deviating from a norm.

Normal K

Overhaul Cycle. That period of time at which an overhaul maintenance task becomes due, as a result either of completion of a given period of time in a Standard Service Tour, or of receiving damage of a severity that warrants overhaul.

Overhaul Cycle R

Periodic/Phase Inspection. Inspection to be accomplished at a specified interval or multiple of the specified intervals.

Periodic/Phase E

Postoperative/Post Flight. Inspection accomplished after each operation/flight.

Postoperative/Post Flight H

Preoperative/Preflight. Inspection accomplished prior to the first operation/flight of the day.

Preoperative/Preflight A

Quarterly. Recurring at 3-month intervals.

Quarterly M

Scheduled. Periodic prescribed inspection/servicing based on an elapsed time, mileage, hours of operation, etc., criteria.

Scheduled B

Semiannually. Occurring every 6 months or twice a year.

Semiannually N

Special. Inspection which supplements other inspections (daily, pre-operational, periodic, flying hours, operating hours, or calendar) and is undertaken because of specific circumstances.

Special F

Turnaround. Performance of the maintenance task occurs during normal turnaround operations and does not affect the operability of the system.

Turnaround T

Unscheduled. Those unpredictable maintenance requirements that had not been previously planned, but require prompt attention to maintain the system in or restore it to operating condition. These tasks may be added to, integrated with, or substituted for previously scheduled work loads.

MIL-STD-1388-2B
APPENDIX E

Unscheduled G

Weekly. Occurring in one of a series of seven-day cycles.

Weekly L

c. Operations/Maintenance Level 1 A F -
(O/M Level)

Codes that are assigned to indicate the maintenance levels authorized to perform the required maintenance function (see DED 277 for definitions of the individual O/M Levels).

Operator/Crew/Unit-Crew	C
Organizational/On Equipment/Unit-Organizational	O
Intermediate/Direct Support/Afloat/ Third Echelon/Off Equipment/Intermediate- Forward	F
Intermediate/General Support/Ashore/ Fourth Echelon/Intermediate-Rear	H
Intermediate/Ashore and Afloat	G
Depot/Shipyards	D
Specialized Repair Activity	L

d. Service Designator Code 1 A F -

A single-position code identifying the military service or nonmilitary major governmental agency having jurisdiction over, or executive management responsibility for, the acquisition (DED 376).

Army	A
Air Force	F
Federal Aviation Administration (FAA)	T
National Security Agency	S
Navy	N
Marine Corps	M
All military	X
Coast Guard	Y
FAA/all military	J
Other	O

e. Operability Code 1 A F -

A code used to indicate the operational status and mission readiness of the item during the maintenance task.

Full Mission Capable. Performance of the maintenance task does not de grade any mission capability. To be Full Mission Capable, a system must have the capability to perform all missions under both peacetime and wartime conditions.

Full Mission Capable C

MIL-STD-1388-2B
APPENDIX E

Partial Mission Capable. Performance of the maintenance task degrades the mission capability of the system. To be in Partial Mission Capable status the system must have the capability to perform at least one war time mission. Systems with no wartime mission must be able to perform any one mission to be in this status.

Partial Mission Capable D

System Inoperable During Equipment Maintenance. During the performance of the maintenance task the system is not available to perform all normal operations.

System Inoperable during Equipment Maintenance A

System Operable During Equipment Maintenance. During performance of the maintenance task the system is available to perform normal operations.

System Operable during Equipment Maintenance B

Not Mission Capable. During performance of the maintenance task the system cannot perform any wartime mission. Systems which have no wartime mission must not be capable of performing any mission in order to be in the Not Mission Capable status.

Not Mission Capable E

Off Equipment Maintenance. Maintenance task is performed after the item under analysis has been removed from the system.

Off Equipment Maintenance G

Turnaround. Performance of the maintenance task occurs during normal turnaround operations and does not affect the operability of the system.

Turnaround F

f. Task Sequence Code 2 X F -

A two-position code assigned to each task. If the combination of the previous task code fields (task function, task interval, service designator, O/M level, and Operability Code) are unique, the entry will be "AA". If the first five fields are duplicated, within an LCN/ALC combination, the follow-on task sequence codes will be AB through 99 to differentiate the tasks.

REFERENCED TASK CODE. A task code that contains referenced task information.

REFERENCED SUBTASK TASK CODE. A task code that contains referenced subtask information.

TASK PROVISION TASK CODE. A task code of the item under analysis.

428 TASK CONDITION 3 A L -

MIL-STD-1388-2B
APPENDIX E

Indicator that special considerations must be taken into account during analysis of the task.

TM/Technical Order use not feasible (inadequate lighting, space constraints, or time constraints) - A Y or N
 TMDE/ATE/BIT/BITE required - B Y or N
 Special tools required - C Y or N

429 TASK CRITICALITY 1 A F -

A single-position code keyed to task level entries in sequential descriptions and used to indicate whether or not the task is critical. A task is critical if failure to accomplish it IAW system requirements would result in adverse effects on system reliability, efficiency, effectiveness, safety, or cost. A task will also be designated as critical whenever system design characteristics approach human limitations, and thereby, significantly increase the likelihood of degraded, delayed, or otherwise impaired mission performance.

Critical Y
 Not critical N

430 TASK FREQUENCY 7 N R 4

The frequency of performance or occurrence of the task identified by the task code and expressed as the number of annual occurrences. For corrective tasks the following formula applies:

$$TF = \left[\sum_{j=1}^M \left[\sum_{i=1}^N FM \text{ Ratio}_i \left(FR + \frac{1}{MTBM-IN} + \frac{1}{MTBM-ND} \right) \times CON \text{ FAC} \right] \right] \times AOR$$

Where:
 TF = Task frequency
 FM Ratio = Failure mode ratio, DED 136
 FR = Failure rate, DED 140
 MTBM-IN = Mean time between Maintenance (induced), DED 231
 MTBM-ND = Mean time between maintenance (no defect), DED 233
 i = Failure mode referencing task under analysis
 N = Number of failure modes referencing task under analysis
 j = Unique LCN/ALC referencing task under analysis
 M = Number of LCN/ALCs referencing task under analysis
 CON FAC = Conversion factor against each LCN/ALC referencing the task under analysis, DED 059
 AOR = Annual operating requirement, DED 023

For preventive tasks, one of the following procedures applies:

Method 1.

$$TF = \frac{\text{Annual Operating Requirement} \times \text{Conversion Factor}}{\text{Maintenance Interval}}$$

MIL-STD-1388-2B
APPENDIX E

Note: Measurement bases for AOR and maintenance interval (DED 208) must be identical. The task frequency calculation is performed for the task reference associated with the maintenance interval.

Method 2. When the frequency of performance of a preventive task is based on calendar time, the task frequency is a numeric expression of the task code, task interval code (DED 427), established as a result of RCM analysis.

Example:	<u>Interval</u>	<u>Task Frequency</u>
	Daily (C)	365.0000
	Weekly (L)	52.0000

431 TASK IDENTIFICATION 36 X L -

A task is a composite of related activities (perceptions, decisions, and responses) performed for an immediate purpose, written in operator/maintainer language. Task identification requires a brief narrative entry consisting of: (a) an action verb which identifies what is to be accomplished in the task or subtask; (b) an object which identifies what is to be acted upon in the task/subtask; and, (c) qualifying phrases needed to distinguish the task from related or similar tasks. Recommended action verbs to be used in preparing task or subtask identifications may be drawn from following list. Some specialized verbs, not listed below may be needed for a particular system/equipment. Many verbs are synonymous. The preparing activity should select one verb which appears closest to the intended meaning for the system/equipment under analysis, and use that verb consistently throughout the analysis. Some verbs are more appropriate for writing statements of tasks, while some verbs are exclusive to subtask elements.

Access. (a) To gain visibility of or the ability to manipulate.
(b) To cause to be displayed, as with a computer menu.

Accomplish. To do, carry out, or bring about; to reach an objective.

Achieve. To carry out successfully.

Acknowledge. To make known the receipt or existence of.

Actuate. To put into mechanical motion or action; to move to action.

Adjust. (a) To bring to a specified position or state. (b) To bring to a more satisfactory state; to manipulate controls, levers, linkages, etc., to return equipment from an out of tolerance condition to an in tolerance condition.

Administer. To manage or supervise the execution, use, or conduct of.

Advance. To move forward; to move ahead.

MIL-STD-1388-2B
APPENDIX E

Advise. To give information or notice to.

Alert. To warn; to call to a state of readiness or watchfulness; to notify (a person) of an impending action.

Align. To bring into line; to line up; to bring into precise adjustment, correct relative position; or coincidence.

Allocate. To apportion for a specific purpose or to particular persons or things.

Allow. (a) To permit; to give opportunity to. (b) To allot or provide for. (c) To carry out a procedure.

Analyze. To examine and interpret information.

Annotate. To append explanatory information to a text or graphic summary of information.

Announce. To make known.

Apply. (a) To lay or spread on. (b) To energize.

Approve. To give official sanction.

Archive. To make an archival copy of.

Arrange. To group according to quality, value, or other characteristics; to put in proper order.

Assault. Close combat phase of an attack.

Assemble. To fit and secure together the several parts of; to make or form by combining parts.

Assess. To determine the importance, size, or value of; to evaluate.

Assign. To apportion to for a specific purpose or to particular persons or things; to appoint to a duty.

Assist. To give support or help; to aid.

Attach. To join or fasten to.

Authenticate. To prove or serve to prove the authenticity of.

Balance. To equalize in weight, height, number, or proportion.

Breach. (a) To break through. (b) To secure passage through.

Brief. To give final precise instructions; to coach thoroughly in advance; to give essential information to.

MIL-STD-1388-2B
APPENDIX E

Bypass. Maneuver around an obstacle, position, or enemy force to maintain momentum of advance.

Calculate. To determine by arithmetic processes.

Calibrate. To determine accuracy, deviation, or variation by special measurement or by comparison with a standard.

Camouflage. To conceal or disguise.

Cancel. To cause not to occur, as in canceling a command.

Categorize. To put into categories or in general classes.

Center. (a) To adjust so that axes coincide. (b) To place in the middle of.

Check. (a) To confirm or establish that a proper condition exists; to ascertain that a given operation produces a specified result; to examine for satisfactory accuracy, safety, or performance; to confirm or determine measurements by use of visual or mechanical means. (b) To perform a critical visual observation or check for specific conditions; to test the condition of.

Chock. To place a blocking device adjacent to, in front of, or behind a wheel to keep it from moving.

Choke. To enrich the fuel mixture of a motor by partially shutting off the air intake of the carburetor.

Choose. To select after consideration.

Chunk. To cause the association of several entities.

Classify. To put into categories or general classes.

Clean. To wash, scrub, or apply solvents to; remove dirt, corrosion, or grease.

Clear. (a) To move people/objects away from. (b) To open the throttle of an idling engine to free it from carbon.

Close. (a) To block against entry or passage; to turn, push, or pull in the direction in which the flow is impeded. (b) To set a circuit breaker into the position allowing current to flow through.

Collect. To bring together into one body or place; to accumulate.

Command. To direct authoritatively.

Communicate. (a) To exchange information. (b) To make known.

Compare. To examine the character or qualities of two or more items; to discover resemblances or differences.

MIL-STD-1388-2B
APPENDIX E

Complete. (a) To bring to an end. (b) To supply missing or needed information, normally in a prescribed format.

Comply. To conform with directions or rules; to accept as authority; to obey.

Compute. To determine by arithmetic process.

Condense. TO make denser, more brief, or more compact.

Connect. (a) To bring or fit together so as to form a unit; to couple keyed or matched equipment items. (b) To attach or mate (an electrical device) to a service outlet.

Construct. (a) To make or form by combining parts; to fit and secure together the several parts of. (b) To assemble information elements or entities in a specified fashion.

Control. To exercise restraining or directing influence over; to fix or adjust the time, amount, or rate of.

Coordinate. To bring into a common action, movement, or condition.

Correct. To make or set right, to alter or adjust so as to bring to some standard or required condition.

Correlate. To establish a mutual or reciprocal relation between.

Cover. To protect or shelter by placing something over or around.

Create. To cause or come into being, normally based on some established criterion.

Debug. To detect and remedy an inadequacy in software.

Decide. To arrive at a solution.

De-energize. To take energy from.

Define. (a) To determine or identify the essential qualities or meaning. (b) To fix or mark the limits of.

Deflate. To release air or gas from.

Delete. To remove from association with or cause no longer to exist.

Deliver. (a) To hand over. (b) To send to an intended target or destination.

Demonstrate. To show clearly.

Depart. To go away; to leave.

Depressurize. To release gas or fluid pressure from.

MIL-STD-1388-2B
APPENDIX E

Derive. To infer or deduce.

Describe. To represent or give an account of in words.

Destroy. To ruin, demolish, or put out of existence; to make unfit for further use.

Detect. To discover or determine the existence, presence, or fact of.

Determine. (a) To obtain definite and first-hand knowledge of, to confirm, or establish that a proper condition exists. (b) To investigate and decide to discover by study or experience.

Develop. To set forth or make clear by degrees or in detail.

Diagnose. To recognize and identify the cause or nature of a condition, situation, or problem by examination or analysis.

Disassemble. To take to pieces; to take apart to the level of the next smaller unit or down to all removable parts.

Disconnect. (a) To sever the connection between; to separate keyed or matched equipment parts. (b) To detach or separate (an electrical device) from a service outlet.

Discriminate. To distinguish or differentiate by discerning or exposing differences.

Disengage. To release or detach interlocking parts; to unfasten; to set free from an inactive or fixed position.

Dismantle. To take apart.

Dismount. (a) To get. (b) To take off.

Displace. To leave one position and take another.

Display. To cause a visual image to be presented on some medium.

Dispose of. To get rid of.

Disseminate. To distribute or disperse to more than one.

Distinguish. To perceive a difference in.

Distribute. To deliver.

Drain. To draw off (liquid) gradually or completely.

Draw. To produce a likeness or representation of.

Drive. To direct the course and motions of a vehicle.

MIL-STD-1388-2B
APPENDIX E

Edit. To correct errors of grammar, syntax, and content in text material.

Effect. To cause the desired result or outcome.

Egress. To go out.

Elaborate. To provide more detail regarding.

Elevate. To lift up; to raise.

Eliminate. To expel; to ignore or set aside as unimportant.

Emplace. To put into position.

Employ. To put into action or service; to carry out a purpose or action by means of; to avail oneself of.

Energize. To impart energy to.

Enforce. To compel or constrain.

Engage. (a) To cause to interlock or mesh. (b) To enter into conflict.

Ensure. (a) To make sure or certain. (b) To guarantee.

Enter. (a) To go or come in. (b) To put on record. (c) To put in information or data.

Erect. To put up by fitting together.

Establish. To set on a firm basis.

Estimate. To judge or determine roughly the size, extent, or nature of.

Evacuate. To move from an area.

Evade. To avoid.

Evaluate. To determine the importance, size, or nature of; to appraise; to give a value or appraisal to on the basis of collected data.

Exchange. To part with or substitute.

Execute. To carry out fully.

Explain. To make something plain and understandable.

Express. To represent in words; to state.

Extract. To draw forth; to pull out forcibly.

Fill out. To enter information on a form.

MIL-STD-1388-2B
APPENDIX E

Find. (a) To discover or determine by search; to indicate the place, site, or limits of. (b) To discover by study or experiment; to investigate and decide.

Fire. To launch a missile or shoot a gun.

Format. To produce in a specified form or style.

Fuel. To provide with fuel.

Harden. To protect.

Hold. To have or keep in the grasp.

Hypothesize. To develop a prediction or speculation, of some degree of uncertainty, based on incomplete factual information or theory.

Identify. (a) To establish the identity of. (b) To determine the classification of.

Illustrate. To make clear or clarify.

Implement. To place into effect.

Indicate. To point out.

Inform. To make known to; to give notice or report the occurrence of.

Initialize. To place in an initial or beginning condition.

Input. To enter information into a computer or data system.

Insert. To put or thrust in, into, or through.

Inspect. To perform a critical visual observation or check for specific conditions; to test the condition of.

Install. (a) To perform operations necessary to properly fit an equipment unit into the next larger assembly or system. (b) To place or attach.

Instruct. To provide with authoritative information or advice.

Integrate. To bring together information from two or more different sources for the purpose of combining analysis or presentation.

Intercept. To stop or interrupt the progress or course of.

Interchange. To remove one item from an assembly and install a like item in the same assembly.

Interpret. (a) To conceive in the light of individual belief, judgment, or circumstance. (b) To explain the meaning of.

MIL-STD-1388-2B
APPENDIX E

Investigate. To observe or study by close examination and systematic inquiry.

Isolate. To use test equipment to identify or select a source of trouble.

Issue. To put forth or distribute.

Lead. To go at the head.

Lift. To move or cause to be moved from a lower to a higher position; to elevate.

List. To enumerate; to write the names of a group of items together.

Listen. To hear something with thoughtful attention.

Load. To place in or on; to place cargo or components on an airplane or other vehicle.

Locate. (a) To find, determine, or indicate the place, site, or limits of. (b) To set or establish in a particular spot; to station.

Log. (a) To record for purposes of keeping records. (b) To gain access to a computer system or terminate interaction with a computer system.

Lubricate. To put lubricant on specified locations.

Maintain. (a) To hold or keep in a particular state or condition, especially in a state of efficiency or validity. (b) To sustain or keep up.

Manage. To handle or direct with a degree of skill.

Maneuver. To make a series of changes in direction and position for a specified purpose.

Measure. To determine the dimensions, capacity, or amount by use of standard instruments or utensils.

Modify. To alter or change somewhat the form or qualities of.

Monitor. (a) Visually to take note of or to pay attention to in order to check on action or change. (b) To attend to displays continually or periodically to determine equipment condition or operating status.

Mount. To attach to a support.

Move. To change the location or position of.

Name. To identify by name.

Navigate. To operate and control course of.

Neutralize. To destroy the effectiveness of; to nullify.

MIL-STD-1388-2B
APPENDIX E

Notify. To make known to; to give notice or report the occurrence of.

Observe. (a) To conform one's actions or practice to. (b) To take note of visually; to pay attention to.

Obtain. (a) To get or find out by observation or special procedures. (b) To gain or attain.

Occupy. (a) To reside. (b) To control.

Open. (a) To move from closed position; to make available for passage by turning in an appropriate direction. (b) To make available for entry or passage by turning back, removing, or clearing away.

Operate. To control equipment in order to accomplish a specific purpose.

Organize. To arrange elements into a whole of interdependent parts; to form into a coherent unity; to integrate.

Orient. (a) To acquaint with the existing situation or environment. (b) To set or arrange in a determinate position.

Originate. To give rise to, to set going, to begin.

Pack. To gather.

Park. To bring a vehicle to a stop and leave it standing for a time in a specified area.

Perform. To do, carry out, or bring about; to reach an objective. Place. To put or set in a desired location or position.

Plan. To devise or project the achievement of.

Plot. To mark or note on or as if on a map or chart; to locate by means of coordinates.

Police. (a) To make clean. (b) To put in order.

Position. To put or set in a given place. Post. To station at a given place.

Prepare. To make ready; to arrange things in readiness. Prescribe. To lay down as a guide, direction, or rule of action; to specify with authority.

Press. To act upon through thrusting force exerted in contact.

Pressurize. To apply pressure within by filling with gas or liquid.

Prevent. To keep from happening or existing.

MIL-STD-1388-2B
APPENDIX E

Prioritize. To arrange or list in order of priority or importance.

Process. To submit to a series of actions or operations leading to a particular end.

Procure. (a) To bring about. (b) To acquire or obtain.

Produce. To cause to come into being or visibility.

Program. To work out a plan or procedure or a sequence of operations to be performed.

Protect. To shield from damage, injury, or destruction.

Provide. To supply what is needed, to equip.

Publish. To produce for distribution.

Pull. To exert force upon an object so as to cause motion toward the force.

Pump. (a) Raise or lower by operating a device which raises, transfers, or compresses fluids by suction, pressure or both. (b) To move up and down or in and out as if with a pump handle.

Purge. (a) To expel unwanted fluids from. (b) To cause to be eliminated or disassociated from.

Push. (a) To press against with force so as to cause motion away from the force. (b) To move away or ahead by steady pressure.

Qualify. To declare competent or adequate.

Queue. To cause to be placed in a queue or ordered sequence of similar processes.

Raise. To move or cause to be moved from a lower to a higher position; to elevate.

Reach. To arrive at.

React. To respond.

Read. To derive information from written material.

Recall. To bring forth information from memory.

Receive. To come into possession of; to get.

Recognize. To perceive to be something previously known or designated.

Recommend. To counsel and advise that something be done.

MIL-STD-1388-2B
APPENDIX E

Reconnoiter. To obtain information by visual observation, or other detection methods.

Record. To set down in writing. Recover. To get back; to regain.

Redistribute. To reallocate.

Refuel. To put fuel into the tanks of a vehicle again.

Release. (a) To set free from an inactive or fixed position; to unfasten or detach interlocking parts. (b) To let go of. (c) To set free from restraint or confinement.

Relocate. To change the place or position of.

Remove. (a) To perform operations necessary to take an equipment unit out of the next larger assembly or system. (b) To take off or eliminate. (c) To take or move away. (d) To take off devices for closing off the end of a tube.

Reorganize. To organize again.

Repair. To restore damaged, wornout, or malfunctioning equipment to a serviceable, usable, or operable condition.

Repeat. To make, do, or perform again.

Replace. (a) To restore to a former place of position. (b) To substitute serviceable equipment for malfunctioning, wornout, or damaged equipment.

Replenish. To fill again.

Report. (a) To describe as being in a specified state. (b) To make known to; to give notice or report the occurrence of.

Represent. To cause information to be conveyed in a fashion different from the original.

Request. To ask for.

Reset. To put back into a desired position, adjustment, or condition.

Resolve. To eliminate discrepancies from two or more sources of information.

Respond. To react.

Resume. To begin again.

Retrieve. To cause to be removed from storage or other unavailable state and made accessible.

MIL-STD-1388-2B
APPENDIX E

Review. To examine again; to go over or examine critically or deliberately.

Rotate. To cause to revolve about an axis or center.

Route. To send by a selected course of travel; to divert in a specified direction.

Run. To cause a computer program to be executed by a computer.

Save. To cause to be stored or placed in an accessible location.

Scan. To make a wide, sweeping search of; to look through or over hastily.

Schedule. To appoint, assign, or designate for a fixed future time; to make a timetable of.

Search. To examine a context to determine the presence of a particular entity or type of entity.

Secure. To make fast or safe.

Select. To take by preference or fitness from a number or group; to pick out, to choose.

Send. To dispatch by means of communication.

Service. To perform such operations as cleanup, lubrication, and replenishment to prepare for use.

Set. (a) To put a switch, pointer, or knob into a given position; to put equipment into a given adjustment, condition or mode. (b) To put or place in a desired orientation, condition, or location.

Set up. To prepare or make ready for use.

Show. To point out or explain.

Shut down. To perform operations necessary to cause equipment to cease or suspend operation.

Sight. (a) To look at through or as if through a sight. (b) To aim by means of sights.

Signal. To notify or communicate by signals (i.e., a prearranged sign, notice or symbol conveying a command, warning, direction or other message).

Solve. To find a solution for.

Specify. To name or state explicitly or in detail.

Squeeze. To force or thrust together by compression.

MIL-STD-1388-2B
APPENDIX E

Start. To perform actions necessary to set into operation; to set going; to begin.

State. To express the particulars of in words.

Stay. To remain; to continue in a place.

Steer. To direct the course of.

Stop. To perform actions necessary to cause equipment to cease or suspend operation.

Store. To cause to be placed in an accessible location.

Stow. To deposit or leave in a specified place for future use.

Strike. To deliver or aim a blow or thrust; to hit.

Submit. To make available; to offer.

Summarize. To tell in or reduce to a summary.

Supervise. To oversee; to have or exercise the charge of.

Support. To assist; help.

Sweep. To clean.

Synthesize. To combine or produce by synthesis.

Take. (a) To get into or carry in one's hands or one's possession. (b) To get or find out by observation or special procedures.

Tap. To strike lightly.

Task. To assign responsibility.

Tell. To express in words.

Test. To perform specified operations to verify operational readiness of a component, subcomponent, system, or subsystem.

Tighten. (a) To perform necessary operations to fix more firmly in place. (b) To apply a specified amount of force to produce a rotation or twisting motion to fix more firmly in place.

Trace. To follow or study out in detail or step by step.

Transfer. To cause an entity to change location or association with other entities.

Transmit. (a) To convey or cause to pass from one place to another. (b) To send out a signal by radio waves or wire.

MIL-STD-1388-2B
APPENDIX E

Transport. (a) To convey or cause to pass from one place to another. (b) To carry by hand or in vehicle or hoist, or in a container, etc.

Traverse. To move from side to side.

Treat. To care for medically.

Troubleshoot. To localize and isolate the source of a malfunction or break down.

Turn. To cause to revolve about an axis or center.

Type. To enter information into a device by means of a keyboard.

Unload. To take off.

Update. To replace older, possibly invalid, information with more current information.

Use. To put into action or service; to avail oneself of; to carry out a purpose or action by means of.

Utilize. To put into action or service; to avail oneself of; to carry out a purpose or action by means of.

Validate. To ascertain the correctness of, using an independent source of information.

Verify. (a) To confirm or establish that a proper condition exists. (b) To establish the truth or accuracy of.

Visualize. To create a mental picture or concept of.

Wait. To suspend activity in a sequence of activities until a given condition occurs or a set time has elapsed.

Write. To inscribe words on a surface.

Zero. To bring to a desired level or null position.

SUBTASK IDENTIFICATION. A brief narrative identification of a subtask.

432 TASK REMARKS

240 X L -

A very brief description of peculiar or unusual maintenance requirements associated with a specific task. These statements are included in section IV of the maintenance allocation chart (MAC).

433 TASK TYPE

1 A F -

A code that categorizes a maintenance task as being either corrective, a preventive based on calendar time, or a preventive based on a rate of use.

MIL-STD-1388-2B
APPENDIX E

	Corrective		C
	Preventive (calendar)		P
	Preventive (usage)		U
434	TECHNICAL DATA PACKAGE (TDP)	1 A F -	
	A single-position code indicating whether or not an adequate TDP is available for procurement of TMDE test programs and TPIs to test the UUT.		
	Available		Y
	Not available		N
435	TECHNICAL EVALUATION PRIORITY CODE	3 X F -	
	A code indicating the technical evaluation status. Level of test, and asset requirement associated with each item of support equipment.		
436	TECHNICAL MANUAL CHANGE NUMBER (TM CHG)	2 N R -	
	A change number reflecting the current edition of a specific manual.		
437	TECHNICAL MANUAL CODE (TM CODE)	3 X F -	
	The identification code assigned to a specific manual.		
438	TECHNICAL MANUAL FUNCTIONAL GROUP GROUP CODE (TM FGC)	11 X L -	
	An alphanumeric code used to identify a particular system, subsystem, component/assembly, or part of the system/equipment used for development of maintenance allocation charts, narrative technical manuals, and repair parts and special tools lists. Codes will be as specified by the requiring authority.		
	TECHNICAL MANUAL FUNCTIONAL GROUP CODE (MAINTENANCE ALLOCATION CHART). The TM FGC required for maintenance allocation identification.		
	TECHNICAL MANUAL FUNCTIONAL GROUP CODE (REPAIR PARTS MANUAL). The TM FGC required for repair parts manual identification.		
439	TECHNICAL MANUAL INDENTURE CODE (TM IND)	1 N F -	
	A code used to indent item names in the repair part description column in a manual to depict disassembly parts relationship within a figure of the text. Codes are: "1" through "5", which indents the item in the parts manual listing by the number specified.		
440	TECHNICAL MANUAL NUMBER	30 X L -	

MIL-STD-1388-2B
APPENDIX E

The technical manual, technical order or manual controlling number assigned by the requiring authority.

INTEROPERABLE ITEM TECHNICAL MANUAL NUMBER. The technical manual number for the interoperable item.

441 TECHNICAL MANUAL REQUIRED CODE(S) 17 X L -

A series of a maximum of six, two-character codes separated by commas. Codes may range from "01" to "30", and are provided by the requiring authority. Codes are specified in DI-ILSS-80118C.

442 TEST ACCURACY RATIO (TAR) 1 X F -

A one-position code specifying a ratio. The TAR is determined by dividing the maximum permitted error of the unit to be measured or calibrated by the maximum known error of the measuring or generating device used to perform the measurement. The codes can be used for the desired TAR or the actual TAR.

<u>TAR Greater Than or Equal To</u>	<u>Code</u>
1:1	1
2:1	2
3:1	3
4:1	4
5:1	5
6:1	6
7:1	7
8:1	8
9:1	9
10:1	0

SE UUT PARAMETER TAR DESIRED. The desired TAR of the TMDE in conjunction with the SE UUT.

SE UUT PARAMETER TEST ACCURACY RATIO ACTUAL. The actual TAR of the TMDE in conjunction with the SE UUT.

UUT PARAMETER TAR DESIRED. The desired TAR of the TMDE in conjunction with the UUT.

UUT PARAMETER TEST ACCURACY RATIO ACTUAL. The actual TAR of the TMDE in conjunction with the UUT.

443 TEST LANGUAGE 6 A L -

The language used for expressing the test specifications and procedures. The particular test-oriented language, used in the preparation and documentation of test procedures, independent of particular test equipment used. A test language can be implemented either manually or with automatic or semiautomatic test equipment.

MIL-STD-1388-2B
APPENDIX E

444 TEST MEASUREMENT AND DIAGNOSTIC 1 A F -
EQUIPMENT REGISTER CODE (TMDE CODE)

A code which further defines the TMDE Register Index Number. Codes are as follows:

Preferred Item List Item	A
Nearest Preferred Item List Item	B
TMDE Register Item	C
Nearest TMDE Register Item	D
Register contains no usable item	E

445 TEST MEASUREMENT AND DIAGNOSTIC 7 X F -
EQUIPMENT REGISTER INDEX NUMBER

A seven-digit index number assigned to each item in DA Pamphlet 700-20, DA TMDE Register.

446 TEST POINTS 1 A F -

A single-letter code indicating whether test points are available on the support/test equipment to test for integrity utilizing additional support/test equipment.

Test points	Y
No test points	N

447 TEST REQUIREMENTS DOCUMENT INDICATOR 1 A F -

A single-letter code indicating whether the fault isolated replaceable unit has a test requirements document assigned to it.

Assigned	Y
Not assigned	N

448 TEST REQUIREMENTS DOCUMENT NUMBER (TRD) 15 X L -

The number assigned to the Test Requirements Document in accordance with the convention specified in MIL-STD-1519.

SE UUT TEST REQUIREMENTS DOCUMENT NUMBER. A TRD number of the support equipment unit under test.

UUT TEST REQUIREMENTS DOCUMENT NUMBER. A TRD number of the unit under test.

449 TEST SCORE 3 N R -

The minimum acceptable skill level test score necessary to qualify an individual for regular training. The specific skill level tests will be supplied by the requiring authority.

450 TEXT SEQUENCING CODE (TSC) 5 N R -

MIL-STD-1388-2B
APPENDIX E

A code used to sequence text within the applicable Text Data Element Definitions. Codes begin with "1" and continue through "99999".

ADDITIONAL REQUIREMENTS TEXT SEQUENCING CODE. A TSC used with additional requirements narrative.

BASELINE FACILITY NARRATIVE TEXT SEQUENCING CODE. A TSC used with four baseline facility narratives.

FACILITY NARRATIVE TEXT SEQUENCING CODE. A TSC used with two facility narratives.

FAILURE MODE AND RCM NARRATIVE TEXT SEQUENCING CODE. A TSC used with six failure and reliability centered maintenance narratives.

FAILURE MODE INDICATOR MISSION PHASE CHARACTERISTICS NARRATIVE TEXT SEQUENCING CODE. A TSC used with two failure mode/mission phase narratives.

NEW OR MODIFIED FACILITY NARRATIVE TEXT SEQUENCING CODE. A TSC used with nine new or modified facility narratives.

PARTS MANUAL TEXT SEQUENCING CODE. A TSC used with provisioning nomenclature.

PROVISIONING TEXT SEQUENCING CODE. A TSC used with provisioning remarks.

PHYSICAL AND MENTAL REQUIREMENTS TEXT SEQUENCING CODE. A TSC used with physical and mental requirements.

RAM CHARACTERISTICS NARRATIVE TEXT SEQUENCING CODE. A TSC used with five reliability, availability, and maintainability characteristics narratives.

SEQUENTIAL SUBTASK DESCRIPTION TEXT SEQUENCING CODE. A TSC used with subtask narratives.

SERD REVISION TEXT SEQUENCING CODE. A TSC used with SERD revision remarks.

SUPPORT EQUIPMENT NARRATIVE TEXT SEQUENCING CODE. A TSC used with each of the eight SE narrative.

SYSTEM END ITEM NARRATIVE TEXT SEQUENCING CODE. A TSC used with three system end item narratives.

TRANSPORTED END ITEM NARRATIVE TEXT SEQUENCING CODE. A TSC used with five transported end item narratives.

TRANSPORTATION NARRATIVE TEXT SEQUENCING CODE. A TSC used with 13 transportation narratives.

UUT EXPLANATION TEXT SEQUENCING CODE. A TSC used with Unit Under Test narrative.

MIL-STD-1388-2B
APPENDIX E

451	THEATER OF OPERATION	5 A L -
	The theater of operation for the system/equipment.	
	Pacific	P
	Atlantic	A
	European	E
	Southern	S
	Central	C
452	TOTAL ITEM CHANGES (TIC)	2 N R -
	The number of times the item is affected by the design change or the cumulative total number of design changes affecting the item.	
	<u>Option 1.</u> The total number of times the line item is affected by the design change.	
	<u>Option 2.</u> The cumulative total number of design changes affecting the PLISN.	
453	TOTAL QUANTITY RECOMMENDED	6 N R -
	A recommended quantity of an item required to support a specific number of applications for a specific period of time. The applications may be to a weapon system, end item, component or combinations thereof, which are contained in the applicable contract.	
454	TOTAL SYSTEMS SUPPORTED	6 N R -
	The total number of systems intended for operational use.	
455	TOWING SPEED	3 N R -
	The maximum towing speed of the system/equipment in miles per hour.	
456	TRACKED GROUND CONTACT PRESSURE	7 N R -
	Specify the ground pressure created by the heaviest pad (pounds per square inch).	
457	TRACKED PAD SHOE AREA	6 N R 1
	A numeric value describing the size of the tracked shoe pad actually in contact with the ground of the transported item in units contained in the associated UM.	
458	TRACKED PADS TOUCHING	2 N R -
	The number of tracked shoe pads actually in contact with the ground.	
459	TRACKED ROAD WHEEL WEIGHT	6 N R 1

MIL-STD-1388-2B
APPENDIX E

The weight in pounds supported by the road wheel of the tracked item.

460 TRAINING COST 7 N R 2

The cost in dollars, of training a single SSC.

461 TRAINING LOCATION RATIONALE 4 A L -

Denotes any of the following reasons for recommending the training location to be classroom or on job training:

Field equipment available for training purposes	A
Field equipment not available for training purposes	B
Task learning difficulty	C
Theory, principles, or verbalized concepts required	D
Probability of deficient performance	E
Percent of work force performing the task	F
Percent of total time spent performing the task	G

462 TRAINING RATIONALE 4 A L -

Denotes any of the following reasons for recommending training for a task:

Frequency of Performance. Training required due to task frequency; i.e., the task might rate low for training priority if it is rarely performed. A

Probable Consequence of Inadequate Performance. Points to the need for selecting tasks for training that are essential to job performance. Consequences of inadequate performance on certain tasks could result in injury to personnel, loss of life, or damage to equipment. B

Task Delay Tolerance. A measure of how much delay can be tolerated between the time the need for task performance becomes evident and the time actual performance must begin. This is based upon known time constraints associated with the equipment, which, if ignored, will result in equipment loss or damage, e.g., loss of power to a computer must be restored within a set time interval or stored memory is lost. C

Task Learning Difficulty. The learning difficulty of a task refers to the time, effort, and assistance required to achieve performance proficiency. D

Probability of Deficient Performance. Used to ensure that training is given in those essential job skills in which job incumbents frequently perform poorly. E

Immediacy of Performance. The criteria of the immediacy of performance are: F

MIL-STD-1388-2B
APPENDIX E

1. Whether or not there is a high probability of the graduate encountering the task on the job fairly soon after completing training. "Fairly soon" means, in this context, that task encountered within the first year after training.

2. The predicted or measured amount of decay of the skill that will take place during the time interval.

Percent of Work Force Performing the Task. Points to the need for training tasks that are most often performed on the job. G

Percent of Total Work Time Spent Performing the Task. Points to a need for providing training to assist job incumbents in efficient performance of those tasks on which they spend the most time. H

463 TRAINING RECOMMENDATION 1 A F -

A single-position code indicating when a task is recommended for training and what type of training is needed. Training, in this context, does not include equipment familiarization.

Class and on the job training (OJT) B
Class C
OJT J
No training necessary N

464 TRANSPORTATION CHARACTERISTICS MODE TYPE 1 A F -

A code which describes how the system/equipment can be transported.

Air A
Helicopter B
Highway C
Lighterage D
Rail E
Ship F

465 TRANSPORTATION CHARACTERISTICS NUMBER 2 N R -

A code which identifies each different way that a system/equipment can be transported. This is a numeric character assigned in sequence.

466 TRANSPORTATION COST 4 N R 2

The cost per pound per mile, expressed in dollars and cents, for transportation of material.

467 TRANSPORTATION END ITEM INDICATOR 1 A F -

A code that signifies whether the LCN represents a system/end item requiring transportation requirements documentation.

MIL-STD-1388-2B
APPENDIX E

	System/End Item requires transportation documentation.		Y
	System/End Item does not require transportation documentation.		N
468	TRANSPORTATION INDICATOR	1 A F -	
	A code that signifies whether the shipping modes for the item or the transport end items itself is being analyzed.		
	Shipping modes		S
	Transported end item		E
	Both shipping modes and transported end item		B
469	TRANSPORTATION ITEM DESIGNATOR (SHIP, LITERAGE, AIRCRAFT, HELICOPTER)	26 X L -	
	The Item Designation (DED 179) of the transport vehicle.		
470	TRANSPORTATION NARRATIVE CODE	1 A F -	
	A code that indicates the transportation narrative.		
	Transportation shock vibration remarks, DED 382		A
	Lifting and tiedown remarks, DED 192		B
	Transportation projection remarks, DED 471		C
	Regulatory requirements, DED 340		D
	Transportation remarks, DED 472		E
	Special service and equipment, DED 398		F
	Sectionalized remarks, DED 368		G
	Transport to and from, DED 476		H
	Environmental considerations, DED 099		I
	Military distance classification, DED 240		J
	Unusual and special requirements, DED 500		K
	Venting and protective clothing, DED 504		L
	Disaster response force, DED 082		M
471	TRANSPORTATION PROJECTION REMARKS	65 X - -	
	Narrative explanation of the projection points of the item to be transported.		
472	TRANSPORTATION REMARKS (HANDLING, TOWING, AIR DROP, SELF-PROPELLED)	65 X - -	
	Narrative explanation of any of the handling characteristics, towing characteristics, self-propelled characteristics, or air drop information.		
473	TRANSPORTATION CONFIGURATION NUMBER	2 N R -	
	A code which differentiates each mobility type. This is a sequentially assigned number beginning with 1 through 99.		

MIL-STD-1388-2B
APPENDIX E

- 474 TRANSPORTED END ITEM NARRATIVE CODE 1 A F -
A code that indicates the transported end item narrative.
Wheeled tire requirements, DED 511 A
Skid remarks, DED 385 B
Turning information, DED 477 C
Wheeled axle and suspension remarks, DED 506 D
Transported other equipment, DED 475 E
- 475 TRANSPORTED OTHER EQUIPMENT 65 X - -
Narrative explanation of any equipment being transported other than wheeled, tracked, or skid mounted.
- 476 TRANSPORT TO AND FROM 65 X - -
Narrative explanation of where the item is being transported to and from.
- 477 TURNING INFORMATION 65 X - -
For wheeled vehicles only, in narrative format the 90 degree and 180 degree turning radius in both wall-to-wall and curb-to-curb.
- 478 TYPE ACQUISITION 1 A F -
The type of acquisition for the system/equipment.
Research, development test and evaluation R
Nondevelopmental item N
Product improvement item P
Commercial construction equipment C
Rebuy B
Foreign source F
- 479 TYPE CLASSIFICATION 1 A F -
A single-position code which indicates the status of a material support system in relation to its overall life history as a guide to procurement, authorization, logistical support, asset, and readiness reporting.
Contingency C
Exempt from type classification E
Limited production L
Not separately type classified N
Obsolete O
Standard S
- 480 TYPE EQUIPMENT CODE 4 X L -
A government supplied code identifying an end item in the maintenance data collection subsystem (MDCS) by its application to the specific type/model/series of aircraft or equipment which it supports.

MIL-STD-1388-2B
APPENDIX E

481 TYPE OF CHANGE CODE 1 A F -
(TOCC)

NOTE: When preparing or updating relational tables, only TOCC "D" can be used. Other codes listed are associated with a manual LSA-036 summary preparation. These codes are assigned to the appropriate LSA-036 card by an automated LSA-036 summary.

This block, which is blank on initial submissions of provisioning data, shall be used as a type of change code to indicate deletions, modifications, typographical errors, quantity changes (increase, decrease), and limited part applications as follows:

Indicates a deleted item	D
Deletion of a data element	G
Item is replaced during production and support of the old part may be required for prior production quantities	L
Indicates a modified item. Required to identify entries for those items changed as a result of either administrative or engineering requirements (not for initial entry of NSN) before or during production.	M

Examples of changes follow:

- a. Prime contractor's reference number
- b. Commercial and government entity code
- c. Manufacturer's reference number
- d. Item name.
- e. Other data elements as may be subsequently defined, wherein the hardware is not affected.

Used to make quantity field changes	Q
Used to make a typographical error correction (not automatically assigned)	T

SYSTEM/EI TYPE OF CHANGE CODE. The TOCC of the system/end item as a model (A indenture code) item.

482 TYPE OF CONSTRUCTION 65 X - -

A narrative description of the construction type required. Included are estimated number of years the facility will be needed, required or preferred locations, and need for relocatability, and identification of any estimated future expansion. Provided information on any special construction, such as shock, hardness, and special floor loads.

483 TYPE OF FACILITY 1 A F -

A code identifying the facility type either operational, test, training or depot.

MIL-STD-1388-2B
APPENDIX E

	Test facility		A
	Operational facility		B
	Training facility		C
	Depot facility		D
484	TYPE OF SUPPLY SYSTEM CODE	1 A F -	
	A letter code indicating the type of supply system to be employed.		
	Nonvertical		N
	Vertical		V
	Direct exchange		X
485	TYPE OF UNIT OF MEASURE/ISSUE PRICE CODE	1 A F -	
	A code used to define the type of UM or UI Price.		
	Engineering estimate		A
	Federal catalog price		B
	Vendor catalog price		C
	Negotiated price		D
	UI PRICE TYPE OF PRICE CODE. The type of UI price.		
	UM PRICE TYPE OF PRICE CODE. The type of UM price.		
486	UNIT CONTAINER CODE	2 X F -	
	A code to identify the container used to hold the quantity unit pack. For applicable code, see MIL-STD-2073-1 and MIL-STD-2073-2.		
487	UNIT CONTAINER LEVEL	1 A F -	
	A code which indicates the highest level of packing protection provided by the unit container.		
	Unit container not acceptable for shipping.		O
	Unit container acceptable and provides level "A" protection.		A
	Unit container acceptable and provides level "B" protection.		B
	Unit container acceptable and provides level "C" protection.		C
	Unit container not required.		D
	Unit container is acceptable and provides minimum protection with commercial packaging.		X

MIL-STD-1388-2B
APPENDIX E

Unit container is acceptable and affords, Z
or is limited to, special consideration
(e.g., air only, inside storage only).

488 UNIT OF ISSUE (UI) 2 A F -

A code which indicates the UI quantity of an item. The UI quantity is the managing activity's established accounting unit upon which the smallest unit pack is based, accountable records are maintained, and requirements are computed. For applicable codes see DOD 4100.38-M.

489 UNIT OF ISSUE CONVERSION FACTOR 5 N - -
(UI CONVERSION FACTOR)

A quantitative multiplier used to convert the Unit of Measure (DED 491) to the Unit of Issue (DED 488). The data element is composed of two subfields:

a. First Digit. Decimal Locator 1 N F -
Code

A digit (0, 1, 2, 3, or 4) indicating the number of places that the decimal must be moved from the right most position of the second subfield to describe correct decimal placement in that field.

b. Digits 2 through 5. Factor 4 N R AS

The numerical value of the conversion factor.

490 UNIT OF ISSUE PRICE 10 N R 2
(UI PRICE)

The price for one UI of an item. The last two positions of the field represent cents, and the decimal is understood.

491 UNIT OF MEASURE (UM) 2 A F -

The UM, as defined in DOD 4100.38-M. The UM is abbreviated: dz, ea, ft, gl, in, lb, oz, etc., for dozen, each, foot, gallon, inch, pound, ounce, etc., respectively.

FACILITY AREA UNIT OF MEASURE. A UM associated with area.

FACILITY CONSTRUCTION UNIT OF MEASURE. A UM associated with the cost of a facility construction project.

OPERATING DIMENSIONS UNIT OF MEASURE. A UM associated with the length, width, and height of the SE in operational mode.

OPERATING WEIGHT UNIT OF MEASURE. A UM associated with the weight of the SE in operational mode.

PROVISION QUANTITY PER TASK UNIT OF MEASURE. A UM used in conjunction with the provision quantity per task.

MIL-STD-1388-2B
APPENDIX E

SKID AREA UNIT OF MEASURE. A UM associated with the skid area.

STORAGE DIMENSIONS UNIT OF MEASURE. A UM associated with the length, width, and height of the SE in the storage mode.

STORAGE WEIGHT UNIT OF MEASURE. A UM associated with the weight of the SE in the storage mode.

SUPPORT EQUIPMENT SHIPPING DIMENSIONS UNIT OF MEASURE. A UM associated with the length, width, and height of the SE in the shipping mode.

SUPPORT EQUIPMENT SHIPPING WEIGHT UNIT OF MEASURE. A UM associated with the weight of the SE in the shipping mode.

SUPPORT ITEM QUANTITY PER TASK UNIT OF MEASURE. A UM used in conjunction with the support item quantity per task.

TRACKED PAD SHOE AREA UNIT OF MEASURE. A UM associated with tracked pad shoe area.

492 UNIT OF MEASURE PRICE 10 N R 2
(UM PRICE)

The best estimated price per UM. The last two positions of the field represent cents, and the decimal is understood.

FACILITY CONSTRUCTION UNIT OF MEASURE PRICE. The best estimated price for facility construction per UM.

493 UNIT PACK CUBE 7 N R 3

The length times width times depth (or cubic dimensions) of the unit container expressed in feet.

494 UNIT PACK SIZE 12 N - -

The length, width, and depth of the unit container or package expressed in inches. Subfields are:

a. Length 4 N R 1

b. Width 4 N R 1

c. Depth 4 N R 1

495 UNIT PACK WEIGHT 5 X - -

The gross weight of the unit pack expressed in pounds. The field is structured as follows:

a. For weights up to 9,999.9 pounds 5 N R 1

b. For weights over 9,999.9 pounds 5 X - -

MIL-STD-1388-2B
APPENDIX E

First subfield. 1 A F -

Multiplier code indicates that the number entered in the second subfield should be multiplied by 10, 100 or 1000 in order to correctly represent the unit pack weight. Codes are as follow:

10 X weight	A
100 X weight	B
1000 X weight	C

Second subfield. 4 N R AS

Numerical value of the weight expressed in pounds.

496 UNIT SIZE 12 N - -

The length, width, and height of the item, as configured for packaging, expressed in inches. Subfields are as follow:

a. Length	4 N R 1
b. Width	4 N R 1
c. Height	4 N R 1

497 UNIT WEIGHT 5 X - -

The unpackaged weight of the item expressed in pounds. The field is structured as follows:

a. For weights up to 9,999.9	5 N R 1
b. For weights over 9,999.9	5 X - -

First subfield. 1 A F -

Multiplier code indicates that the number entered in the second subfield should be multiplied by 10, 100 or 1000 in order to correctly represent the unit weight. Codes are as follow:

10 X weight	A
100 X weight	B
1000 X weight	C

Second subfield. 4 N R AS

Numerical values of the weight expressed in pounds.

498 UNIT UNDER TEST EXPLANATION 65 X - -

Narrative statements which further explain, justify, or substantiate any data entry concerning unit UUT related data (U) tables.

499 UNSCHEDULED MAINTENANCE 10 N - AS

MIL-STD-1388-2B
APPENDIX E

Maintenance requirements which cannot be scheduled for performance on a regular, predetermined interval, and must be added to, integrated with, or substituted for previously scheduled work loads. The data chain consists of the following data elements:

- a. Mean Elapsed Time, DED 224 5 N R 2
 - b. Mean Man-Hours, DED 225 5 N R 2
- 500 UNUSUAL AND SPECIAL TRANSPORTATION REQUIREMENTS 65 X - -

Identification of any unusual item characteristics to be considered for transportation and packaging purposes. Some of these considerations are: temperature limits; pressure limits; electrical sources required during transit; humidity control required; escorts required; etc.

- 501 USABLE ON CODE (UOC) 3 X L -

A code that indicates the configuration of a system/equipment on which the item under analysis is used. The UOC represents only one configuration/model of equipment. It is a one, two, or three-character alphanumeric entry with guidance for UOC assignment provided by the requiring authority. When an item is applicable to multiple equipment configurations, multiple UOCs representing each configuration are assigned to the item.

- 502 UTILITIES REQUIREMENTS 65 X - -

A narrative description identifying an estimate of the total connected load, or other gross quantity of utilities required for each facility. Includes any unusual or critical requirements, energy conservation requirements, and continuous power requirements. Provides specific identification of the class of utility, e.g., electric power, hydraulic power, compressed air, water, and sewage.

- 503 UTILIZATION RATIO 3 N R 2

The portion of time available for a repairman with a given skill specialty to support the weapon system being documented. (This should only be used if the repairman works on more than one system.)

- 504 VENTING AND PROTECTIVE CLOTHING REQUIREMENTS 65 X - -

Identification of all venting and protective clothing requirements necessary for the transportation of the item.

- 505 WEAROUT LIFE 6 N R -

The operational interval of flight hours, calendar time, or other appropriate independent variable, from initial installation until an item can no longer perform its intended mission, due to the depletion of some physical property or material. For a family of items, wearout occurs

MIL-STD-1388-2B
APPENDIX E

when the conditional probability of failure (hazard rate) increases with increases of the independent variable.

- 506 WHEELED AND AXLE REQUIREMENTS 65 X - -
The load ratings for each suspension and the axle loads for each axle for the both an empty and loaded vehicle. This may apply to both tracked and wheeled vehicles.
- 507 WHEELED INFLATION PRESSURE 3 N R -
The inflation pressure of the tire. This may apply to both tracked and wheeled vehicles.
- 508 WHEELED NUMBER OF PLYS 2 N R -
The number of plies of the tire. This may apply to both tracked and wheeled vehicles.
- 509 WHEELED NUMBER OF TIRES 2 N R -
The number of tires for the vehicle. This may apply to both tracked and wheeled vehicles.
- 510 WHEELED TIRE LOAD RATING 10 X L -
The load ratings of the tire. This may apply to both tracked and wheeled vehicles.
- 511 WHEELED TIRE REQUIREMENTS 65 X - -
A narrative description of the tire requirements. This may apply to both tracked and wheeled vehicles.
- 512 WHEELED TIRE SIZE 10 X L -
The size of the tire. This may apply to both tracked and wheeled vehicles.
- 513 WHEELED WEIGHT RATINGS 10 X L -
The weight ratings of the tire. This may apply to both tracked and wheeled vehicles.
- 514 WORK AREA CODE 4 X L -
An alphanumeric code assigned to the area of work (e.g., wheelwell) when a maintenance function is to be performed at a specific location.
- 515 WORD PACKAGE REFERENCE 6 X L -
A six-position entry identifying the technical manual/technical order section showing all tools and SE used to maintain the articles requiring support.

MIL-STD-1388-2B
APPENDIX E

SE UUT WORK PACKAGE REFERENCE. The work package reference of the SE UUT.

UUT WORK PACKAGE REFERENCE. The work package reference of the UUT.

516 WORK UNIT CODE 7 X L -

An alphanumeric code used to identify a particular system, subsystem, component/assembly, or part of the system/equipment. Codes will be as specified by the requiring authority.

517 WRAPPING MATERIAL 2 X F -

A code which indicates the type of wrapping material to be used on the item. For applicable codes, see MIL-STD-2073-1 and MIL-STD-2073-2.

518 YEAR 2 N F -

The calendar year depicted as decade and unit of year only.

THIS PAGE INTENTIONALLY LEFT BLANK

MIL-STD-1388-2B
APPENDIX F

Appendix F

LIST OF LOGISTIC SUPPORT ANALYSIS RECORD ACRONYMS

10. PURPOSE. This appendix is to be used to reference and understand the acronyms and expressions used in MIL-STD-1388-2B.

20. ACRONYMS.

a	Failure Mode Ratio
A _a	Achieved Availability
A _i	Inherent Availability
A _o	Operational Availability
A	Allocated
AAL	Additional Authorization List
AC/DC	Alternating Current/Direct Current
ACT CD	Activity Code
ADP	Automated Data Processing
ADPE	Automatic Data Processing Equipment
AELs	Allowance Equipment Lists
AFM	Air Force Manual
AFQT	Armed Forces Qualifications Test
AFR	Air Force Regulation
AIC	Allowance Item Code
AID	Adaptor Interconnect Device
ALC	Alternate Logistic Support Analysis Control Number Code
ALDT	Administrative and Logistics Delay Time
AMC	Acquisition Method Code
AMSC	Acquisition Method Suffix Code
AMSDL	Acquisition Management Systems and Data Requirements Control List
ANL M-H	Annual Man-Hours
ANSI	American National Standards Institute
AOR	Annual Operating Requirements
APL	Allowance Part List
AR	Army Regulations
ARN	Additional Reference Number
ARNSE	Additional Reference Number Select
ASO	Aviation Supply Office
ASVAB	Armed Services Vocational Aptitude Battery
ATE	Automatic Test Equipment
AVIM	Aviation Intermediate Maintenance
AVUM	Aviation Unit Maintenance
B	Failure Effect Probability
BCD	Binary Coded Decimal
BDAR	Battle Damage Assessment and Repair
BDG	Brigade
BDSR	Below Depot Scrap Rate
BII	Basis Of Issue Items
BIT	Built-In-Test
BITE	Built-In-Test-Equipment
BN	Battalion
BOI	Basis Of Issue

MIL-STD-1388-2B
APPENDIX F

C _m	Failure Mode Criticality Number
C _r	Item Criticality Number
C	Comparative Analysis
CAD	Condemnation At Depot
CAGE	Commercial and Government Entity
CAL	Calibration
CALS	Computer-aided Acquisition and Logistic Support
CBD	Condemnation Below Depot
CBIL	Common and Bulk Item List
CD	Cleaning and Drying Procedures
CDRL	Contract Data Requirement List
CE	Concept Exploration
CFE	Contractor Furnished Equipment
CFI	Card Format Indicator
CFR	Code of Federal Regulations
CIC	Critical Item Code
CLS	Contractor Logistic Support
CMRS	Calibrations Measurement Requirements Summary
COEI	Components of End Item
CON FAC	Conversion Factor
CONUS	Continental United States
COSAL	Coordinated Shipboard/Allowance List
CPC	Concurrent Production Code
CR	Contractor Recommended
CSN	Card Sequence Number
CT	Cushioning Thickness
CTIC	Contractor Technical Information Code
CTP	Coordinated Test Plan
CTRL	Control
DAC	Document Availability Code
DCN	Design Change Notices
DD	Design Development
DDCC	Design Data Category Code
DED	Data Element Definitions
DEST CD	Destination Code
DIC	Document Identifier Code
DID	Data Item Description
DLSC	Defense Logistics Service Center
DMIL	Demilitarization Code
DOD	Department of Defense
DOP	Degree Of Protection
DRP	Designated Rework Point
DS	Direct Support
DSR	Depot Scrap Rate
EBCDIC	Extended Binary Coded Decimal Interchange Code
EC	Essentiality Code
E-CAGE/PN	Equivalent Commercial and Government Entity and Part Number
EFM-MTBF	Engineering Failure Mode Mean Time Between Failure
EI	End Item
EIAC	End Item Acronym Code
ELIN	Exhibit Line Item Number
ESML	Expendable/Durable Supplies and Materials List
ESS	Early Supply Support
F	Part Failure Rate
FAA	Federal Aviation Administration

MIL-STD-1388-2B
APPENDIX F

FDC	Facility Drawing Classification
FGC	Functional Group Code
FEP	Failure Effect Probability
FI	Front Inside
FIRU	Fault Isolated Replaceable Unit
FLSIP	Fleet Logistic Support Improvement Program
FM	Failure Mode
FMEA	Failure Modes and Effects Analysis
FMECA	Failure Modes, Effects, and Criticality Analysis
FMI	Failure Mode Indicator
FMR	Failure Mode Ratio
FMT	Failure Mode Task
FO	Front Outside
FR	Failure Rate
FSC	Federal Supply Classification
FSD	Full Scale Development
FY	Fiscal Year
GFAE	Government Furnished Aeronautical Equipment
GFE	Government Furnished Equipment
GIC	Gabaret International De Chargement
GR	Government Required
HC	Hazardous Code
HCI	Hardness Critical Item
HCP	Hardness Critical Procedures
HMI	Hazardous Material Indicator Code
HMPC	Hazardous Maintenance Procedures Code
HQ	Headquarters
IA	Inherent Availability
IAW	In Accordance With
IC	Indenture Code
ICC	Item Category Code
ICP	Inventory Control Point
ICQ	Intermediate Container Quantity
ICS	Interim Contractor Support
ID	Identification
ILS	Integrated Logistic Support
IMAC	Industrial Materials Analysis of Capacity
IMC	Item Management Code
IMF	Inherent Maintenance Factor
IND CD	Indenture Code
I/O	Input/Output
I/R	Interchangeability/Replaceability
IRCC	Integrated Logistic Support Requirement Category Code
ISIL	Interim Support Item List
ISL	Integrated Stock List
ISO	International Organization of Standards
ISS	Initial Spares Support Listing
JETDS	Joint Electronics Type Designation System
LCC	Life Cycle Cost
LCN	Logistic Support Analysis Control Number
LCN-IC	Logistic Support Analysis Control Number - Indenture Code
LDO	Logistic Decision Office
LIN	Line Item Number
LLTIL	Long Lead Time Items List
LORA	Level of Repair Analysis

MIL-STD-1388-2B
APPENDIX F

LRU	Line Replaceable Unit
LSA	Logistic Support Analysis
LSAR	Logistic Support Analysis Record
M	Measured
MAC	Maintenance Allocation Chart
MAC	Maintenance Action Code
MAM	Maintenance Assistance Modules
MAMDT	Mean Active Maintenance Downtime
MANPRINT	Manpower and Personnel Integration
MAOT	Maximum Allowable Operating Time
MARC	Manpower Requirement Criteria
MAXTTR	Maximum Time to Repair
MB	Measurement Base
MDCS	Maintenance Data Collection Subsystem
MDT	Mean Down Time
MET	Mean Elapsed Time
MIE	Mission Item Essentiality Code
MH	Man-Hour
M/L	Maintenance Level
MMM	Mean Man-Minutes
MMMh	Measured Mean Man-Hours
MOS	Method of Support
MOSM	Method of Support Modifier
MPC	Mission Phase Code
MRF	Maintenance Replacement Factor
MRR	Maintenance Replacement Rate
MRR I	Maintenance Replacement Rate I
MRR II	Maintenance Replacement Rate II
MRSA	Matériel Readiness Support Activity
MRU	Minimum Replacement Unit
MTBF	Mean Time Between Failure
MTBM	Mean Time Between Maintenance
MTBMA	Mean Time Between Maintenance Actions
MTBPM	Mean Time Between Preventive Maintenance
MTBR	Mean Time Between Removals
MTBTMA	Mean Time Between Task Maintenance Actions
MTCH	Match Code
MTD	Maintenance Task Distribution
MTE	Manual Test Equipment
MTPM	Mean Preventive Maintenance Action Time
MTTR	Mean Time To Repair
NALC	Navy Ammunition Logistic Code
NATO	North Atlantic Treaty Organization
NC	Number of Corrective Maintenance Actions
NHA	Next Higher Assembly
NHA IND	Next Higher Assembly Provisioning List Item Sequence Number Indicator
NHA PLISN	Next Higher Assembly Provisioning List Item Sequence Number
NI	Not Interchangeable
NIIN	National Item Identification Number
NOFF	Non-Operability Fragility Factor
NP	Number of Preventive Maintenance Actions
NRTS	Not Repairable This Station
NSN	National Stock Number
NSO	Numeric Stockage Objective

MIL-STD-1388-2B
APPENDIX F

OBRP	On Board Repair Part
ODRC	Output Data Research Code
OJT	On the Job Training
O/M	Operations and Maintenance
O/M LVL	Operations and Maintenance Level
OP	Operation Level
OPI	Optional Procedures Indicator
ORR	Overhaul Replacement Rate
OSI	Operating Space Item
OT	Operating Time
OTP	Operational Test Program
OW	One-Way
P	Predicted
PCB	Printed Circuit Board
PCCN	Provisioning Contract Control Number
PCI	Price Challenge Indicator
PCL	Post Conference List
PCS	Permanent Change of Station
PCT	Percent
PCTL	Percentile
PF	Productivity Factor
PGC	Parameter Grouping Code
PIC	Priority Indicator Code
PICA	Prime Inventory Control Activity
PII	Procurement Instrument Identification
PIIN	Procurement Instrument Identification Number
PL	Provisioning List
PLCC	Provisioning List Category Code
PLISN	Provisioning List Item Sequence Number
PLT	Production Lead Time
PMAC	Preliminary Maintenance Allocation Chart
PMCS	Preventive Maintenance Checks and Services
PMIC	Precious Metal Indicator Code
PMR	Planned Maintenance Requirements
PMS	Planned Maintenance System
PPL	Provisioning Parts List
PPLI	Provisioning Parts List Index
PPSL	Program Parts Selection List
PR/O	Pilot Rework/Overhaul
PSCN	Permanent System Control Number
PSICP	Program Support Inventory Control Point
PS/PC	Physical Security/Pilferage Code
PTD	Provisioning Technical Documentation
PTLD	Physical Teardown Logistic Demonstration
PUC	Provisioning Unit of Measure/Issue Price Code
QPA	Quantity Per Assembly
QPEI	Quantity Per End Item
QTY/ASSY	Quantity Per Assembly
QTY-AUTH	Quantity Authorized
QTY/EI	Quantity Per End Item
QUP	Quantity Per Unit Pack
RAM	Reliability, Availability, and Maintainability
RAM IC	Reliability, Availability, and Maintainability Indicator Code
RCM	Reliability Centered Maintenance
RCT	Repair Cycle Time

MIL-STD-1388-2B
APPENDIX F

R&D	Research and Development
RDC	Reference Designation Code
RDOC	Reference Designator Overflow Code
REP	Repair
RI	Rear Inside
RIL	Repairable Items List
RIP	Remain-In-Place Indicator
RISS BUY	Recommended Minimum System Stock Buy
R&M	Reliability and Maintainability
RMSS LVL	Recommended Minimum System Stock Level
RNCC	Reference Number Category Code
RNVC	Reference Number Variation Code
RO	Rear Outside
RPF	Rotatable Pool Factor
RPSTL	Repair Parts and Special Tools List
RRR	Rework Removal Rate
RS/IND	Replace or Supersede Provisioning List Item Sequence Number Indicator
RSR	Repair Survival Rate
RSS	Ready Service Spare
RTD	Replacement Task Distribution
RTLL	Recommended Tender Load List Quantity
R/V	Range/Value
SAIP	Spares Acquisition Integrated With Production
SAR	System Attrition Rate
SC	Support Concept
SCI	Supplemental Card Indicator
SCPL	System Configuration Provisioning List
SE	Support Equipment
SEC	Security Clearance
SER	Service Designator Code
SERD	Support Equipment Recommendation Data
SEUUT	Support Equipment Unit Under Test
SFPPL	Short Form Provisioning Part List
SHSC	Safety Hazard Severity Code
SI	Special Item Code
SIASCN	Standard Interservice Agency Serial Control Number
SIC	Suppression Indicator Code
SL	Shelf Life
SL	Skill Level
SLAC	Shelf Life Action Code
SLC	Skill Level Code
SMCC	Special Material Content Code
SMIC	Special Maintenance Item Code
SMR	Source, Maintenance, and Recoverability Code
S/N	System End Item Serial Number
SNSL	Stock Number Sequence List
SOW	Statement Of Work
SPCC	Ship Parts Control Center
SPI	Special Packaging Instruction
SPIIN	Supplemental Procurement Instrument Identification Number
SPI REV	Special Packaging Instruction Number Revision
SRA	Special Repair Activity
SSC	Skill Specialty Code
SSE	Skill Specialty Evaluation Code

MIL-STD-1388-2B
APPENDIX F

SSI	Special Stockage Indicator
ST	Standby Time
ST	Status
SUB CONT NO	Submitter's Control Number
SVC	Service Company
SYS/EI	System/End Item
t	Operating Time
TAR	Test Accuracy Ratio
TC	Task Criticality
TCM	Total Corrective Maintenance
TDP	Technical Data Package
TF	Task Frequency
TIC	Total Item Changes
TIR	Total Item Record
TM	Technical Manual
TM CHG NO	Technical Manual Change Number
TM CODE	Technical Manual Code
TMDE	Test, Measurement, and Diagnostic Equipment
TMDE CODE	Test, Measurement, and Diagnostic Equipment Code
TM FGC	Technical Manual Functional Group Code
TM IC	Technical Manual Indenture Code
TM IND	Technical Manual Indenture Code
TOCC	Type of Change Code
TO&E	Table of Organization and Equipment
TOR	Technical Override
TPI	Test Program Instruction
TPM	Total Preventive Maintenance
TPS	Test Program Set
TRD	Test Requirements Document Number
TSC	Text Sequencing Code
TTEL	Tools and Test Equipment List
TUC	Type of Unit of Measure/Issue Price Code
UI	Unit of Issue
UM	Unit of Measure
UOC	Usable On Code
USAMC	United States Army Materiel Command
UUT	Unit Under Test
WRMC	War Readiness Material Code
WUC	Work Unit Code

THIS PAGE INTENTIONALLY LEFT BLANK

LSAR DATA REQUIREMENTS FORM
GENERAL INFORMATION

Selection of a data element shall constitute the selection of all data keys or data dependencies required to document the element in the LSAR. Where more than one data element code applies to a data selection, the Code column contains dashes (-). For narrative data, where each data element definition is separately selectable to a common data table, the code column is blank.

This Form consists of two sections. The first section consists of government furnished data. The second section consists of the LSAR Data Requirements Form and is divided into three parts. Part I is LSAR data selected by an entry in the required column. Part II is LSAR provisioning data selected by an entry in the type of provisioning list. Part III is packaging data selected by an entry under a packing categorization.

Explanation of codes appearing under the KEY column are provided below:

KEY	KEY EXPLANATION
K	Data table key. It is required when any data element of the table is selected.
F	Foreign key. It originates in another data table and is required prior to a data element of the table being documented. Foreign keys appear only once on the data requirements form within a major area, e.g., Task Analysis and Personnel and Support Requirement.
M	Mandatory data. It is a nonidentifying data element that is required when entering information in the data table.
G	Data element provided by the requiring authority.
B	Data element that is both a key/foreign key and is provided by the requiring authority.
A	Army peculiar data element.
N	Navy peculiar data element.
R	Air Force peculiar data element.
C	Marine Corps peculiar data element.

PART II Provisioning Requirements

MEDIA

7-Track	_____	Even Parity	_____	BCD Coded	_____
9-Track	_____	Odd Parity	_____	EBCDIC Coded	_____
800 BPI	_____	1600 BPI	_____	6250 BPI	_____
Number of records per block is: _____					

Figure 71. Example of DD-Form 1949-3

MIL-STD-1388-2B

LSAR DATA REQUIREMENTS FORM GENERAL INFORMATION				
The appropriate code(s) for the header data and sequence should be entered in the appropriate spaces for the Type Provisioning Lists.				
HEADER DATA				
Procurement Instrument Identification (PIIN/SPIIN)				P
Nomenclature or Model or Type Number				N
Control Data				C
Prime Commercial and Government Entity				E
Submission Control Code				S
Date (YYMMDD)				Y
Sequence (Provisioning List Item Sequence Number assignment):				
Logistic Support Analysis Control Number	Topdown			T
	Disassembly			D
	Reference Designation			X
Reference Number				R
Type Provisioning Lists:	Specify	(T,D,X,R)	Required (P,N,C,E,S,Y)	Conference Required (Y,N)
Long Lead Time Items List (LLTIL)	_____		_____	_____
Provisioning Parts List (PPL)	_____		_____	_____
Short Form PPL (SFPPL)	_____		_____	_____
Common and Bulk Items List (CBIL)	_____		_____	_____
Repairable Items List (RIL)	_____		_____	_____
Interim Support Items List (ISIL)	_____		_____	_____
Post Conference List (PCL)	_____		_____	_____
Tools and Test Equipment List (TTEL)	_____		_____	_____
System Configuration PPL (SCPPL)	_____		_____	_____
Design Change Notices (DCN)	_____		_____	_____
As Required (ARA) and specified in the SOW	_____		_____	_____
As Required (ARB) and specified in the SOW	_____		_____	_____
		Required(Y,N)	Time	Date (YYMMDD)
Provisioning Guidance Conference	_____	_____	_____	_____
Location _____				
Provisioning Conference	_____	_____	_____	_____
Location _____				
Provisioning Preparedness Review Conference	_____			
PART III, Packaging Requirements				
Common, MIL-STD-2073-1B, paragraph 3.3.1				
Selective, MIL-STD-2073-1B, paragraph 3.3.2				
Special, MIL-STD-2073-1B, paragraph 3.3.3				
Other Instructions				

Figure 71. Example of DD-Form 1949-3

MIL-STD-1388-2B

LSAR DATA REQUIREMENTS FORM GENERAL INFORMATION	
Header Data should be documented for each type provisioning list identified.	
Type Provisioning List _____	
HEADER DATA	
Procurement Instrument Identification (PIIN/SPIIN) _____	
Nomenclature or Model or Type Number _____	
Control Data _____	
Prime Commercial and Government Entity _____	
Submission Control Code _____	
Date (YYMMDD) _____	
Provisioning Activity (Address and Zip Code) _____	
Contractor Name (Address and Zip Code) _____	
Answer these question as yes or no. (Y or N)	
Interim Support Items (Required)	_____
Incremental Submission (Authorized)	_____
Resident Provisioning Team (Established)	_____
Interim Release (Authorized)	_____
Provisioning Performance Schedule (Required)	_____
Repair Kits and Repair Part Sets (Included)	_____
Military Service/Agency Addendum (Attached)	_____
Common and Bulk Items List (Options 1-5, Select 1) _____	
Delivery of Support Items Will Be (Concurrent, Scheduled, Not Scheduled, Select 1) _____	
Engineering Data for Provisioning (Microfilm, Hard Copy, Aperture Cards, Digital/CALS) _____	
Engineering Data for Provisioning (Will be sequenced by Reference Designation, PLISN, Reference Number, Other, Select 1) _____	

Figure 71. Example of DD-Form 1949-3

MIL-STD-1388-2B

LSAR DATA REQUIREMENTS FORM
SECTION 1 GOVERNMENT FURNISHED DATA

This information should be filled out by the requiring authority and should pertain to the End Item only.

Table XA

End Item Acronym Code, DED 096	_____
Administrative Lead Time, DED 014	_____
Contact Team Delay Time, DED 052	_____
Contract Number, DED 055	_____
Cost Per Reorder Action, DED 061	_____
Cost Per Requisition, DED 062	_____
Demilitarization Cost, DED 077	_____
Discount Rate, DED 083	_____
Estimated Salvage Value, DED 102	_____
Holding Cost Percentage, DED 160	_____
Intial Bin Cost, DED 166	_____
Initial Cataloging Cost, DED 167	_____
Interest Rate, DED 173	_____
Inventory Storage Space Cost, DED 176	_____
Loading Factor, DED 195	_____
Operation Level, DED 271	_____
Operation Life, DED 272	_____
Personnel Turnover Rate Civ, DED 289	_____
Personnel Turnover Rate Mil, DED 289	_____
Productivity Factor, DED 300	_____
Recurring Bin Cost, DED 333	_____
Recurring Cataloging Cost, DED 334	_____
Retail Stockage Criteria, DED 359	_____
Safety Level, DED 363	_____
Support of Support Equipment, DED 421	_____
Transportation Cost, DED 466	_____
Type Acquisition, DED 478	_____
Type of Supply System Code, 484	_____

Table AI

Modeling Service Des. Code, DED 376	_____
Modeling O/M Level Code, DED 277	_____
Labor Rate, DED 189	_____
Number of Shops, DED 263	_____
Repair Work Space Cost, DED 352	_____
Required Days of Stock, DED 357	_____

Table AJ

O/M Level From, DED 277	_____
O/M Level To, DED 277	_____
Ship Distance, DED 085	_____
Ship Time, DED 379	_____

Table AK

Add. Supportability Consids, DED 010	_____
Add. Supportability Parameters, DED 011	_____
Oper. Mission Failure Def., DED 274	_____

Figure 71. Example of DD-Form 1949-3

MIL-STD-1388-2B

LSAR DATA REQUIREMENTS FORM
SECTION 1 GOVERNMENT FURNISHED DATA

This information should be filled out by the requiring authority and should pertain to the Item (LSA Control Number) under analysis.

Table XB

LSA Control Number, DED 199

Table XC

Usable On Code, DED 501

System/End Item PCCN, DED 307

Table AA

Service Designator Code, DED 376

Required MTTR, DED 222

Required Percentile, DED 286

Required Ach. Availability, DED 001

Required Inh. Availability, DED 164

Operational MAMDT, DED 223

Technical MAMDT, DED 223

Required Operational MTTR, DED 236

Required Technical MTTR, DED 236

Number of Operating Locations, DED 262

Crew Size, DED 064

Total Systems Supported, DED 454

RCM Logic Utilized, DED 345

Table AB

Operational Reqt Indicator, DED 275

Annual Number of Missions, DED 021

Annual Operating Days, DED 022

Annual Operating Time, DED 024

Mean Mission Duration, DED 228

Mean Mission Duration MB, DED 238

Required Op. Availability, DED 273

Required ALDT, DED 013

Required Standby Time, DED 403

Table AC

O/M Level, DED 277

Maintenance Level MaxTTR, DED 222

Maintenance Level Percentile, DED 286

Number of Systems Supported, DED 265

Maint. Level Scheduled AMH, DED 020

Maint. Level Unscheduled AMH, DED 020

Scheduled MH/Operating Hour, DED 215

Unscheduled MH/Operating Hour, DED 215

Unscheduled Maintenance MET, DED 499

Unscheduled Maintenance MMH, DED 499

Table AD

Daily Inspection MET, DED 280

Daily Inspection MMH, DED 280

Preoperative Inspection MET, DED 280

Preoperative Inspection MMH, DED 280

Figure 71. Example of DD-Form 1949-3

MIL-STD-1388-2B

LSAR DATA REQUIREMENTS FORM	
SECTION 1 GOVERNMENT FURNISHED DATA	
Post Operative Inspection MET, DED 280	_____
Post Operative Inspection MMH, DED 280	_____
Periodic Inspection MET, DED 280	_____
Periodic Inspection MMH, DED 280	_____
Mission Profile Inspection MET, DED 280	_____
Mission Profile Inspection MMH, DED 280	_____
Turnaround Inspection MET, DED 280	_____
Turnaround Inspection MMH, DED 280	_____
Table AE	
Available Man Hour, DED 028	_____
Available Quantity, DED 324	_____
Utilization Ratio, DED 503	_____
Table AF	
Additional Requirements, DED 009	_____
Table AG	
AOR MB, DED 238	_____
Annual Operating Requirement, DED 023	_____
Operational Reqt Indicator, DED 275	_____
Required Operational MTBF, DED 229	_____
Required Technical MTBF, DED 229	_____
Required Operational MTBMA, DED 230	_____
Required Technical MTBMA, DED 230	_____
Required MTBR, DED 235	_____
Table AH	
Interoperable Item Name, DED 182	_____
Interoperable Number Type, DED 266	_____
Interoperable CAGE Code, DED 046	_____
Interoperable Reference Number, DED 337	_____
Interoperable Item NIIN, DED 253	_____
Interoperable Item NSN FSC, DED 253	_____
Interoperable Item TM Number, DED 440	_____

Figure 71. Example of DD-Form 1949-3

LSAR DATA REQUIREMENTS FORM
SECTION 1 GOVERNMENT FURNISHED DATA

This information should be filled out by the requiring authority and should pertain to a piece of Support Equipment that is supporting the item under analysis.

Table EA and EB

Support Equipment Cage, DED 046 _____
SE Reference Number, DED 337 _____

Table EA

Acquisition Decision Office, DED 002 _____
Logistics Decision Office, DED 198 _____
Management Plan, DED 216 _____
SMR Code, DED 389 _____
Program Element, DED 301 _____
Program Sup. Inv. Control Pt., DED 303 _____
Revolving Assests, DED 361 _____
Spare Factor, DED 390 _____
Special Management Code, DED 393 _____
SIASC Number, DED 401 _____
SE Shipping Height, DED 419 _____
SE Shipping Length, DED 419 _____
SE Shipping Width, DED 419 _____
SE Shipping Weight, DED 420 _____
Type of Equipment Code, DED 480 _____

Table EB

Allowance Document Number, DED 016 _____
Allowance Range 1, DED 015 _____
Allowance Range 2, DED 015 _____
Allowance Range 3, DED 015 _____
Allowance Range 4, DED 015 _____
Allowance Range 5, DED 015 _____
Allowance Range 6, DED 015 _____
Allowance Range 7, DED 015 _____
Allowance Range 8, DED 015 _____
Allowance Range 9, DED 015 _____
Allowance Range 10, DED 015 _____
Allocation Designation Descr., DED 015 _____
Allocation Extended Range, DED 015 _____
Allocation Land Vessel Code, DED 015 _____
Allocation Manut. Lvl Function, DED 015 _____
Allocation Station ID Code, DED 015 _____

Figure 71. Example of DD-Form 1949-3

LSAR DATA REQUIREMENTS FORM
SECTION 1 GOVERNMENT FURNISHED DATA

This information should be filled out by the requiring authority and should pertain to the item under analysis.

Table UA

UUT LSA Control Number, DED 199 _____
UUT Maintenance Plan Number, DED 209 _____

Table HA

CAGE Code, DED 046 _____
Reference Number, 337 _____
Acquisition Method Code, DED 003 _____
Acquisition Method Suffix Code, DED 004 _____

Table HG and HP

Cage Code, DED 046 _____
Reference Number, DED 337 _____
LSA Control Number, DED 199 _____

Table HG

Provisioning Sys ID Code, DED 312 _____

Table HP

Change Authority Number, DED 043 _____

Figure 71. Example of DD-Form 1949-3

MIL-STD-1388-2B

Part I	LSAR DATA REQUIREMENTS FORM			Section 2
DATA ELEMENT TITLE	KEY	DED	CODE	REQUIRED
CROSS FUNCTIONAL REQUIREMENT				
Table XA, END ITEM ACRONYM CODE				
END ITEM ACRONYM CODE	K	096	EIACODXA	
LCN STRUCTURE		202	LCNSTRXA	
ADMINISTRATIVE LEAD TIME	G	014	ADDLTMXA	
CONTACT TEAM DELAY TIME	G	052	CTDLTMXA	
CONTRACT NUMBER	G	055	CONTNOXA	
COST PER REORDER ACTION	G	061	CSRORXA	
COST PER REQUISITION	G	062	CSPRRQXA	
DEMILITARIZATION COST	G	077	DEMILCXA	
DISCOUNT RATE	G	083	DISCNTXA	
ESTIMATED SALVAGE VALUE	G	102	ESSALVXA	
HOLDING COST PERCENTAGE	G	160	HLCSPCXA	
INITIAL BIN COST	G	166	INTBINXA	
INITIAL CATALOGING COST	G	167	INCATCXA	
INTEREST RATE	G	173	INTRATXA	
INVENTORY STORAGE SPACE COST	G	176	INVSTGXA	
LOADING FACTOR	G	195	LODFACXA	
OPERATION LEVEL	G	271	WSOPLVXA	
OPERATION LIFE	G	272	OPRLIFXA	
PERSONNEL TURNOVER RATE	G	289	-----	
PRODUCTIVITY FACTOR	G	300	PROFACXA	
RECURRING BIN COST	G	333	RCBINCXA	
RECURRING CATALOGING COST	G	334	RCCATCXA	
RETAIL STOCKAGE CRITERIA	G	359	RESTCRXA	
SAFETY LEVEL	G	363	SAFLVLXA	
SUPPORT OF SUPPORT EQUIPMENT COST FACTOR	G	421	SECSFCXA	
TRANSPORTATION COST	G	466	TRNCSTXA	
TYPE ACQUISITION	G	478	WSTYAQXA	
TYPE OF SUPPLY SYSTEM CODE	G	484	TSSCODXA	
Table XB, LCN INDENTURED ITEM				
LSA CONTROL NUMBER (LCN)	K	199	LSACONXB	
ALTERNATE LCN CODE	K	019	ALTLCNXB	
LCN TYPE	K	203	LCNTYPXB	
LCN INDENTURE CODE		200	LCNINDB	
LCN NOMENCLATURE		201	LCNAMEXB	
TM FUNCTIONAL GROUP CODE (MAINT ALLOCATION CHART)		438	TMFGCDXB	
SYSTEM/END ITEM IDENTIFIER		423	SYSIDNXB	
SECTIONALIZED ITEM TRANSPORTATION INDICATOR		367	SECITMNB	
RELIABILITY AVAILABILITY MAINTAINABILITY INDICATOR		342	RAMINDB	
Table XC, SYSTEM/END ITEM (SEE ALSO PART II)				
USABLE ON CODE	G	501	UOCSEIXC	
SYSTEM/EI PCCN	G	307	PCCNUMXC	
SYSTEM/EI ITEM DESIGNATOR CODE		179	ITMDESXC	
TRANSPORTATION END ITEM INDICATOR		467	TRASEIXC	
Table XD, SYSTEM/END ITEM SERIAL NUMBER (SEE ALSO PART II)				
SERIAL NUMBER	K	373	-----	
SERIAL NUMBER USABLE ON CODE		375	SNUUCXD	

Figure 71. Example of DD-Form 1949-3

MIL-STD-1388-2B

Part I	LSAR DATA REQUIREMENTS FORM			Section 2
DATA ELEMENT TITLE	KEY	DED	CODE	REQUIRED
Table XE, LCN TO SERIAL NUMBER USABLE ON CODE				
Table XF, LCN TO SYSTEM/END ITEM USABLE ON CODE				
Table XG, FUNCTIONAL/PHYSICAL LCN MAPPING				
Table XH, COMMERCIAL AND GOVERNMENT ENTITY				
COMMERCIAL AND GOVERNMENT ENTITY (CAGE) CODE	K	046	CAGECDXH	
CAGE NAME		047	CANAMEXH	
CAGE ADDRESS		047	-----	
Table XI, TECHNICAL MANUAL CODE AND NUMBER INDEX				
TECHNICAL MANUAL (TM) CODE	K	437	TMCODEXI	
TM NUMBER	G	440	TMNUMBXI	
OPERATIONS AND MAINTENANCE REQUIREMENTS				
Table AA, OPERATIONS AND MAINTENANCE REQUIREMENTS				
END ITEM ACRONYM CODE	F	096	EIACODXA	
LSA CONTROL NUMBER (LCN)	F	199	LSACONXB	
ALTERNATE LCN CODE	F	019	ALTLCNXB	
LCN TYPE	F	203	LCNTYPXB	
SERVICE DESIGNATOR CODE	K	376	SERDESAA	
REQUIRED MAXIMUM TIME TO REPAIR	G	222	MAXTTRAA	
REQUIRED ACHIEVED AVAILABILITY	G	001	ACHAVAAA	
REQUIRED INHERENT AVAILABILITY	G	164	INHAVAAA	
OPERATIONAL MEAN ACTIVE MAINTENANCE DOWNTIME	G	223	OMAMDtaa	
TECHNICAL MEAN ACTIVE MAINTENANCE DOWNTIME	G	223	TMAMDtaa	
REQUIRED OPERATIONAL MEAN TIME TO REPAIR	G	236	OPMTTRAA	
REQUIRED TECHNICAL MEAN TIME TO REPAIR	G	236	TEMTTRAA	
NUMBER OPERATING LOCATIONS	G	262	NUOPL0AA	
CREW SIZE	G	064	CREWSZAA	
TOTAL SYSTEMS SUPPORTED	G	454	TOSYSUAA	
RELIABILITY CENTERED MAINTENANCE LOGIC UTILIZED	G	345	RCMLOGAA	
Table AB, WAR PEACE OPERATIONS AND MAINTENANCE REQUIREMENT				
OPERATIONAL REQUIREMENT INDICATOR	K	275	OPRQINAB	
ANNUAL NUMBER OF MISSIONS	G	021	ANNOMIAB	
ANNUAL OPERATING DAYS	G	022	ANOPDAAB	
ANNUAL OPERATING TIME	G	024	ANOPTIAB	
MEAN MISSION DURATION	G	228	MMISDUAB	
REQUIRED OPERATIONAL AVAILABILITY	G	273	OPAVAIAB	
REQUIRED ADMINISTRATIVE AND LOGISTIC DELAY TIME	G	013	OPALDTAB	
REQUIRED STANDBY TIME	G	403	OSTBTIAB	
Table AC, MAINTENANCE LEVEL REQUIREMENT				
OPERATIONS AND MAINTENANCE LEVEL CODE	K	277	OMLVLCAC	
MAINTENANCE LEVEL MAXIMUM TIME TO REPAIR	G	222	MLMTTRAC	
NUMBER OF SYSTEMS SUPPORTED	G	265	MLNSSUAC	
MAINTENANCE LEVEL SCHEDULED ANNUAL MAN-HOURS	G	020	MLSAMHAC	
MAINTENANCE LEVEL UNSCHEDULED ANNUAL MAN-HOURS	G	020	MLUAMHAC	
SCHEDULED MAN-HOUR PER OPERATING HOUR	G	215	MLSMHOAC	
UNSCHEDULED MAN-HOUR PER OPERATING HOUR	G	215	MLUMHOAC	

Figure 71. Example of DD-Form 1949-3

MIL-STD-1388-2B

Part I	LSAR DATA REQUIREMENTS FORM			Section 2
DATA ELEMENT TITLE	KEY	DED	CODE	REQUIRED
UNSCHEDULED MAINTENANCE MEAN ELAPSED TIME	G	499	MLUMETAC	
UNSCHEDULED MAINTENANCE MEAN MAN-HOURS	G	499	MLUMMHAC	
Table AD, ORGANIZATIONAL LEVEL REQUIREMENT				
DAILY INSPECTION MEAN ELAPSED TIME	G	280	DINMETAD	
DAILY INSPECTION MEAN MAN-HOURS	G	280	DINMMHAD	
PREOPERATIVE INSPECTION MEAN ELAPSED TIME	G	280	PREMETAD	
PREOPERATIVE INSPECTION MEAN MAN-HOURS	G	280	PREMMHAD	
POST OPERATIVE INSPECTION MEAN ELAPSED TIME	G	280	POIMETAD	
POST OPERATIVE INSPECTION MEAN MAN-HOURS	G	280	POIMMHAD	
PERIODIC INSPECTION MEAN ELAPSED TIME	G	280	PINMETAD	
PERIODIC INSPECTION MEAN MAN-HOURS	G	280	PINMMHAD	
MISSION PROFILE CHANGE MEAN ELAPSED TIME	G	280	MPCMETAD	
MISSION PROFILE CHANGE MEAN MAN-HOURS	G	280	MPCMMHAD	
TURNAROUND INSPECTION MEAN ELAPSED TIME	G	280	TINMETAD	
TURNAROUND INSPECTION MEAN MAN-HOURS	G	280	TINMMHAD	
Table AE, SKILL OPERATIONS AND MAINTENANCE REQUIREMENT				
SKILL SPECIALTY CODE	F	387	SKSPCDGA	
AVAILABLE MAN HOUR	G	028	AVAIMHAE	
AVAILABLE QUANTITY	G	324	QTYAVAAE	
UTILIZATION RATIO	G	503	UTRATIAE	
Table AF, WAR PEACE ADDITIONAL REQUIREMENTS NARRATIVE				
ADDITIONAL REQUIREMENTS	G	009	WPADDRAF	
Table AG, RELIABILITY REQUIREMENT				
ANNUAL OPERATING REQUIREMENT	M	023	ANOPREAG	
OPERATIONAL REQUIREMENTS INDICATOR	M	275	OPRQINAB	
REQUIRED OPERATIONAL MEAN TIME BETWEEN FAILURES	G	229	OPMTBFAG	
REQUIRED TECHNICAL MEAN TIME BETWEEN FAILURES	G	229	TEMTBFAG	
REQUIRED OPERATIONAL MEAN TIME BETWEEN MAINT ACTIONS	G	230	OPMRBMAG	
REQUIRED TECHNICAL MEAN TIME BETWEEN MAINT ACTIONS	G	230	TMTBMAAG	
REQUIRED MEAN TIME BETWEEN REMOVALS	G	235	MTBRXXAG	
Table AH, INTEROPERABILITY REQUIREMENT				
INTEROPERABLE ITEM NAME	K	182	IONAMEAH	
INTEROPERABLE ITEM NUMBER TYPE	K	266	IOINTYAH	
INTEROPERABLE CAGE CODE	G	046	IOCAGEAH	
INTEROPERABLE REFERENCE NUMBER	G	337	IOREFNAH	
INTEROPERABLE ITEM NATIONAL STOCK NUMBER	G	253	-----	
INTEROPERABLE ITEM TECHNICAL MANUAL NUMBER	G	440	IOITNMAH	
Table AI, MODELING DATA				
MODELING SERVICE DESIGNATOR CODE	K	376	SERDESAI	
MODELING OPERATIONS AND MAINTENANCE LEVEL CODE	K	277	OMLVLCAI	
LABOR RATE	G	189	LABRATAI	
NUMBER OF SHOPS	G	263	NOSHPSAI	
REPAIR WORK SPACE COST	G	352	RPWSCSAI	
REQUIRED DAYS OF STOCK	G	357	RQDSTKAI	
Table AJ, OPERATIONS AND MAINTENANCE SHIPPING REQUIREMENTS				

Figure 71. Example of DD-Form 1949-3

MIL-STD-1388-2B

Part I	LSAR DATA REQUIREMENTS FORM			Section 2
DATA ELEMENT TITLE	KEY	DED	CODE	REQUIRED
OPERATIONS AND MAINTENANCE LEVEL FROM	K	277	OMLVLFAJ	
OPERATIONS AND MAINTENANCE LEVEL TO	K	277	OMLVLTAJ	
SHIP DISTANCE	G	085	SHPDISAJ	
SHIP TIME	G	379	TIMESHAJ	
Table AK, SYSTEM END ITEM NARRATIVE				
SYSTEM END ITEM NARRATIVE CODE	K	424	SEINCDAK	
ADDITIONAL SUPPORTABILITY CONSIDERATIONS	G	010		
ADDITIONAL SUPPORTABILITY PARAMETERS	G	011		
OPERATIONAL MISSION FAILURE DEFINITION	G	274		
ITEM RELIABILITY, AVAILABILITY, AND MAINTAINABILITY REQUIREMENTS; FAILURE MODES EFFECTS AND CRITICALITY ANALYSIS; AND MAINTAINABILITY ANALYSIS				
Table BA, RELIABILITY, AVAILABILITY AND MAINTAINABILITY (RAM) CHARACTERISTICS				
END ITEM ACRONYM CODE	F	096	EIACODXA	
LSA CONTROL NUMBER (LCN)	F	199	LSACONXB	
ALTERNATE LCN CODE	F	019	ALTLCNXB	
LCN TYPE	F	203	LCNTYPXB	
MINIMUM EQUIPMENT LIST INDICATOR		243	MEQLINBA	
CONVERSION FACTOR		059	CONVFABA	
FAULT ISOLATION		143	-----	
BIT DETECTABILITY LEVEL PERCENTAGE		032	-----	
BUILT IN TEST CANNOT DUPLICATE PERCENTAGE		031	BITNDPBA	
BUILT IN TEST RETEST OK PERCENT		033	BITROPBA	
FAILURE RATE DATA SOURCE		141	FRDATABA	
PILOT REWORK OVERHAUL CANDIDATE		292	PREOVGBA	
SECURITY CLEARANCE		369	SECCLEBA	
SUPPORT CONCEPT		410	SUPCONBA	
WEAROUT LIFE		505	WEOULIBA	
LOGISTIC CONSIDERATIONS		196	-----	
Table BB, RAM CHARACTERISTICS NARRATIVE				
RAM CHARACTERISTICS NARRATIVE CODE	K	341	RAMCNABB	
ITEM FUNCTION		180		
MAINTENANCE CONCEPT		207		
MINIMUM EQUIPMENT LIST NARRATIVE		244		
QUALITATIVE & QUANTITATIVE MAINTAINABILITY RQMT		315		
MAINTENANCE PLAN RATIONALE		210		
Table BC, RAM LOGISTICS CONSIDERATIONS				
LOGISTICS CONSIDERATION CODE	K	425	LOCOCBC	
RAM LOGISTIC CONSIDERATIONS		426	LOGNARBC	
Table BD, RAM INDICATOR CHARACTERISTICS				
RAM INDICATOR CODE	K	347	RAMINDBD	
ACHIEVED AVAILABILITY		001	ACHAVABD	
INHERENT AVAILABILITY		164	INHAVABD	
FAILURE RATE		140	FAILRTBD	
INHERENT MAINTENANCE FACTOR		165	INHMAFBD	
MAXIMUM TIME TO REPAIR		222	MAXTRBD	

Figure 71. Example of DD-Form 1949-3

MIL-STD-1388-2B

Part I	LSAR DATA REQUIREMENTS FORM			Section 2
DATA ELEMENT TITLE	KEY	DED	CODE	REQUIRED
MEAN TIME TO REPAIR OPERATIONAL		236	MTTROPBD	
MEAN TIME TO REPAIR TECHNICAL		236	MTTRTHBD	
MEAN TIME BETWEEN FAILURES OPERATIONAL		229	OPMTBFBD	
MEAN TIME BETWEEN FAILURES TECHNICAL		229	TEMTBFBD	
MEAN TIME BETWEEN MAINTENANCE ACTIONS OPERATIONAL		230	OMTMBABD	
MEAN TIME BETWEEN MAINTENANCE ACTIONS TECHNICAL		230	TMTMBABD	
MEAN TIME BETWEEN MAINTENANCE INDUCED		231	INMTBMBD	
MEAN TIME BETWEEN MAINTENANCE INHERENT		232	INHMTBBD	
MEAN TIME BETWEEN MAINTENANCE NO DEFECT		233	NOMTBMBD	
MEAN TIME BETWEEN PREVENTIVE MAINTENANCE		234	MTBMPVBD	
MEAN TIME BETWEEN REMOVALS		235	MTBRXXBD	
Table BE, WAR/PEACE RAM INDICATOR CHARACTERISTICS				
RAM OPERATIONAL REQUIREMENT INDICATOR	K	275	OPRQINBE	
ADMINISTRATIVE AND LOGISTIC DELAY TIME		013	ALDTXXBE	
OPERATIONAL AVAILABILITY		273	OPAVAIBE	
STANDBY TIME		403	STABYTBE	
Table BF, FAILURE MODE AND RELIABILITY CENTERED MAINTENANCE (RCM) ANALYSIS				
FAILURE MODE INDICATOR	K	134	FAMOINBF	
ENGINEERING FAILURE MODE MEAN TIME BETWEEN FAILURE		097	EFMTBFBF	
FAILURE MODE CLASSIFICATION		132	FMCLASBF	
FAILURE MODE RATIO		136	FMRATOFB	
RELIABILITY CENTERED MAINTENANCE (RCM) LOGIC RESULTS		344	-----	
RCM DISPOSITION		084	-----	
Table BG, FAILURE MODE AND RCM NARRATIVE				
FAILURE MODE AND RCM NARRATIVE CODE	K	131	FMNCNABG	
FAILURE/DAMAGE MODE EFFECT END EFFECT		125		
FAILURE/DAMAGE MODE EFFECT LOCAL		126		
FAILURE/DAMAGE MODE EFFECT NEXT HIGHER		127		
FAILURE CAUSE		124		
FAILURE/DAMAGE MODE		128		
FAILURE MODE DETECTION METHOD		129		
FAILURE MODE PREDICTABILITY		138		
FAILURE MODE REMARKS		137		
REDESIGN RECOMMENDATIONS		426		
RCM AGE EXPLORATION		343		
RELIABILITY CENTERED MAINTENANCE REASONING		346		
RCM REDESIGN RECOMMENDATIONS		426		
Table BH, FAILURE MODE TASK				
TASK REQUIREMENT LCN	F	199	TLSACNBH	
TASK REQUIREMENT ALTERNATE LCN CODE	F	019	TALCNCBH	
TASK REQUIREMENT LCN TYPE	F	203	TLCNTYBH	
TASK CODE	F	427	TTASKCBH	
TASK TYPE		433	TATYPEBH	
MAINTENANCE INTERVAL		208	MAININBH	
Table BI, FAILURE MODE INDICATOR (FMI) MISSION PHASECODE (MPC) CHARACTERISTICS				
SAFETY HAZARD SEVERITY CODE	M	362	FMSHSCBI	

Figure 71. Example of DD-Form 1949-3

MIL-STD-1388-2B

Part I	LSAR DATA REQUIREMENTS FORM			Section 2
DATA ELEMENT TITLE	KEY	DED	CODE	REQUIRED
FAILURE EFFECT PROBABILITY		130	FEPROBBI	
FAILURE MODE CRITICALITY NUMBER		133	FACRNUBI	
FAILURE PROBABILITY LEVEL		139	FPROBLBI	
OPERATING TIME		269	FMOPTIBI	
Table BJ, FMI MPC CHARACTERISTICS NARRATIVE				
FMI-MPC CHARACTERISTICS NARRATIVE CODE	K	135	FMMPCNBJ	
COMPENSATING DESIGN PROVISIONS		049		
COMPENSATING OPERATOR ACTION PROVISIONS		050		
Table BK, RAM CRITICALITY				
RAM SAFETY HAZARD SEVERITY CODE	K	362	FMSHSCBK	
RAM ITEM CRITICALITY NUMBER		178	RICRITBK	
Table BL, MISSION PHASE OPERATIONAL MODE				
MISSION PHASE CODE	K	246	MISSPCBL	
MISSION PHASE OPERATIONAL MODE		247	MPOPLDBL	
TASK ANALYSIS AND PERSONNEL AND SUPPORT REQUIREMENT				
Table CA, TASK REQUIREMENT				
END ITEM ACRONYM CODE	F	096	EIACODXA	
LSA CONTROL NUMBER (LCN)	F	199	LSACONXB	
ALTERNATE LCN CODE	F	019	ALTLCNXB	
LCN TYPE	F	203	LCNTYPXB	
TASK CODE	K	427	TASKDCDA	
REFERENCED TASK CODE		427	REFTSKCA	
TASK ANNUAL OPERATING REQUIREMENT MEASUREMENT BASE		238	AORMSBCA	
TASK IDENTIFICATION		431	TASKIDCA	
TASK FREQUENCY		430	TSKFRQCA	
TASK CRITICALITY CODE		429	TSKCRCCA	
HARDNESS CRITICAL PROCEDURE CODE		152	HRDCPCCA	
HAZARDOUS MAINTENANCE PROCEDURES CODE		155	HAZMPCCA	
PREVENTIVE MAINTENANCE CHECKS AND SERVICES INDICATOR		296	PMCSIDCA	
MEASURED MEAN ELAPSE TIME		224	MSDMETCA	
PREDICTED MEAN ELAPSE TIME		224	PRDMETCA	
MEASURED MEAN MAN HOURS		225	MSDMMHCA	
PREDICTED MEAN MAN HOURS		225	PRDMMHCA	
MEANS OF DETECTION		237	-----	
FACILITY REQUIREMENT CODE		358	FTRNRQCA	
TRAINING EQUIPMENT REQUIREMENT CODE		358	TRNRQCCA	
TRAINING RECOMMENDATION TYPE		463	TRNRECCA	
TRAINING LOCATION RATIONALE		461	TRNLOCCA	
TRAINING RATIONALE		462	TRNRATCA	
TOOL/SUPPORT EQUIPMENT REQUIREMENT CODE		358	TSEREQCA	
TASK PERFORMANCE		287	-----	
TASK CONDITION		428	-----	
Table CB, SUBTASK REQUIREMENT				
SUBTASK NUMBER	K	407	SUBNUMCB	
REFERENCED SUBTASK NUMBER		407	RFDSUBCB	
SUBTASK MEAN MINUTE ELAPSE TIME		227	SBMMETCB	
SUBTASK WORK AREA CODE		514	SUBWACCB	

Figure 71. Example of DD-Form 1949-3

MIL-STD-1388-2B

Part I	LSAR DATA REQUIREMENTS FORM			Section 2
DATA ELEMENT TITLE	KEY	DED	CODE	REQUIRED
Table CC, SEQUENTIAL SUBTASK DESCRIPTION				
SEQUENTIAL SUBTASK DESCRIPTION		372	SUBNARCC	
ELEMENT INDICATOR		095	ELEMNTCC	
Table CD, SUBTASK PERSONNEL REQUIREMENT				
SUBTASK PERSON IDENTIFIER	K	288	SUBPIDCD	
SKILL SPECIALTY CODE		387	SKSPCDGA	
NEW OR MODIFIED SKILL SPECIALTY CODE		257	MDCSSCGB	
SUBTASK MEAN MAN MINUTES		226	SUBMMCD	
SKILL SPECIALTY EVALUATION CODE		388	SSECECD	
Table CE, TASK REMARK REFERENCE				
TASK REMARK REFERENCE CODE	K	349	TSKRRCCE	
TASK REMARK	K	432	TSKREMCE	
Table CF, TASK REMARK				
Table CG, TASK SUPPORT EQUIPMENT				
TASK SUPPORT REFERENCE NUMBER	F	337	TSREFNCG	
TASK SUPPORT CAGE CODE	F	046	TSCAGECG	
SUPPORT ITEM QUANTITY PER TASK		319	SQTYTKCG	
Table CH, TASK MANUAL				
TECHNICAL MANUAL CODE	F	437	TMCODEXI	
Table CI, TASK PROVISIONED ITEM				
TASK PROVISION LCN	F	199	PROLCNCI	
TASK PROVISION ALC	F	019	PROALCCI	
TASK PROVISION LCN TYPE	F	203	PROLTYCI	
TASK PROVISION CAGE CODE	F	046	PROCAGCI	
TASK PROVISION REFERENCE NUMBER	F	337	PROREFCI	
PROVISION QUANTITY PER TASK		319	PQTYTKCI	
Table CJ, JOB AND DUTY ASSIGNMENT				
JOB CODE	K	186	JOBCODCJ	
DUTY CODE	K	091	DUTYCDCJ	
JOB		185	JOBDESCJ	
DUTY		090	DUTIESCJ	
Table CK, TASK INVENTORY				
SEQUENTIAL SUBTASK DESCRIPTION TSC FROM	K	450	TSFROMCK	
SEQUENTIAL SUBTASK DESCRIPTION TSC TO	K	450	TEXTTOCK	
SUBTASK PERSON IDENTIFIER	K	288	SUBPIDCD	
SUPPORT EQUIPMENT AND TRAINING MATERIEL REQUIREMENTS				
Task EA, SUPPORT EQUIPMENT				
SUPPORT EQUIPMENT CAGE	F	046	SECAGEEA	
SUPPORT EQUIPMENT REFERENCE NUMBER	F	337	SEREFNEA	
SUPPORT EQUIPMENT FULL ITEM NAME		412	FLITNMEA	
SUPPORT EQUIPMENT ITEM CATEGORY CODE		177	SEICDEA	
ACQUISITION DECISION OFFICE	G	002	AQDCOFEA	
END ARTICLE ITEM DESIGNATOR		179	ENDARTEA	

Figure 71. Example of DD-Form 1949-3

MIL-STD-1388-2B

Part I	LSAR DATA REQUIREMENTS FORM			Section 2
DATA ELEMENT TITLE	KEY	DED	CODE	REQUIRED
ADAPTOR/INTERCONNECTION DEVICE REQUIRED		005	AIDRQDEA	
DATE OF FIRST ARTICLE DELIVERY		071	DATFADEA	
CALIBRATION INTERVAL		037	CALINTEA	
CALIBRATION ITEM		038	CALITMEA	
CALIBRATION REQUIRED		040	CALRQDEA	
CALIBRATION STANDARD		041	CALSTDEA	
CALIBRATION TIME		042	CALTIMEA	
CALIBRATION MEASUREMENT REQUIREMENT SUMMARY RECOMMENDED		035	CMRSRCEA	
CONTRACT NUMBER		055	CNTRNOEA	
CONTRACTOR FURNISHED/GOVERNMENT FURNISHED EQUIPMENT		056	CFEGFEEA	
CUSTODY CODE		069	CUSTCDEA	
DRAWING CLASSIFICATION		088	DRWCLSEA	
ECONOMIC ANALYSIS		093	ECOANLEA	
FAMILY GROUP		142	FAMGRPEA	
GENERIC CODE		148	GENECDEA	
GOVERNMENT DESIGNATOR		149	GOVDESEA	
HARDWARE DEVELOPMENT PRICE		153	HDWRPREA	
INTEGRATED LOGISTIC SUPPORT PRICE		170	ILSPRCEA	
DESIGN DATA PRICE		080	DSNPRCEA	
EXTENDED UNIT PRICE		103	EXUNPREA	
PASS THRU PRICE		285	PASTHREA	
OPERATING AND SUPPORT COST		267	OSCOSTEA	
RECURRING COST		332	RCURCSEA	
LIFE CYCLE STATUS		190	LICYSTEA	
LIFE SPAN		191	LIFSPNEA	
LOGISTIC CONTROL CODE		197	LGCTCDEA	
LOGISTICS DECISION OFFICE	G	198	LGDCOFEA	
LSA RECOMMENDATION CODE		204	LSARCDEA	
MANAGEMENT PLAN	G	216	MGTPLNEA	
MANAGING COMMAND/AGENCY		217	MGCOATEA	
SUPPORT EQUIPMENT MEAN TIME BETWEEN FAILURES		229	SEMTBFEA	
SUPPORT EQUIPMENT MEAN TIME BETWEEN MAINTENANCE ACTIONS		230	SMTBMAEA	
SUPPORT EQUIPMENT MEAN TIME TO REPAIR		236	SEMTTREA	
MOBILE FACILITY CODE		248	MOBFACEA	
MODIFICATION OR CHANGE		252	MODCHGEA	
OPERATING DIMENSIONS		268	-----	
OPERATING WEIGHT		270	OPRWGTEA	
PRINTED CIRCUIT BOARD REPAIR MAINTENANCE LEVEL		277	PCBLVLEA	
SUPPORT EQUIPMENT CALIBRATION MAINTENANCE LEVEL		277	CALLVLEA	
SUPPORT EQUIPMENT (SE) REPAIR MAINTENANCE LEVEL		277	RPRLVLEA	
SE SOURCE, MAINTENANCE AND RECOVERABILITY CODE	G	389	SMRCSEEA	
TECHNICAL MANUAL REQUIRED CODE		441	TMRQCDEA	
OPERATORS MANUAL		278	OPRMANEA	
SKILL SPECIALTY CODE FOR SUPPORT EQUIPMENT OPERATOR		387	SSCOPREA	
PREPARING ACTIVITY		294	PREATYEA	
PROGRAM ELEMENT	G	301	PROLEEA	
PROGRAM SUPPORT INVENTORY CONTROL POINT	G	303	PSICPOEA	
REPORTABLE ITEM CONTROL CODE		356	SERICCEA	
REVOLVING ASSETS	G	361	REVASSEA	
SELF TEST CODE		370	SLFTSTEA	
SENSORS OR TRANSDUCERS		371	SENTRAEA	
SE SERVICE DESIGNATOR		376	SERDESEA	

Figure 71. Example of DD-Form 1949-3

MIL-STD-1388-2B

Part I	LSAR DATA REQUIREMENTS FORM			Section 2
DATA ELEMENT TITLE	KEY	DED	CODE	REQUIRED
USING SERVICE DESIGNATOR CODE		376	USESEREA	
SKETCH		383	SKETCHEA	
SPARE FACTOR	G	390	SPRFACEA	
SPECIAL MANAGMENT CODE	G	393	SPMGNTEA	
STANDARD INTERSERVICE AGENCY SERIAL CONTROL NUMBER	G	401	SIASCNE	
STORAGE DIMENSIONS		405	-----	
STORAGE WEIGHT		406	STOWGTEA	
SUPPORT EQUIPMENT SHIPPING DIMENSIONS	G	419	-----	
SUPPORT EQUIPMENT SHIPPING WEIGHT	G	420	SESHWTEA	
SUPPORT EQUIPMENT GROUPING		413	SEGRCDEA	
SUPPORT EQUIPMENT REQUIRED		418	SEREQDEA	
TECHNICAL EVALUATION PRIORITY CODE		435	TECEVLEA	
TEST LANGUAGE		443	TSTLNGEA	
TEST POINTS		446	TSTPTSEA	
TMDE REGISTER CODE		444	TMDERCEA	
TMDE REGISTER INDEX		445	TMDERIEA	
TYPE CLASSIFICATION		479	TYPCLSEA	
TYPE EQUIPMENT CODE	G	480	TYPEEQEA	
YEAR OF FIELDING		518	YRFLDGEA	
Table EB, ALLOCATION DATA				
ALLOWANCE DOCUMENT NUMBER	B	016	ALDCNMEB	
ALLOWABLE RANGE 1-10 AND EXTENDED RANGE	G	015	-----	
ALLOCATION DESIGNATION DESCRIPTION	G	015	ALDNDSEB	
ALLOCATION LAND VESSEL CODE	G	015	ALLVCDEB	
ALLOCATION MAINTENANCE LEVEL FUNCTION	G	015	ALMLVLEB	
ALLOCATION STATION IDENTIFICATION CODE	G	015	ALSTIDEB	
Table EC, SUPPORT EQUIPMENT PARAMETERS				
SUPPORT EQUIPMENT PARAMETERS	K	284	-----	
CALIBRATION PROCEDURE		039	CALPROEC	
Table ED, SUPPORT EQUIPMENT AUTHORIZATION				
SPECIFIC AUTHORIZATION	B	399	-----	
Table EE, SUPPORT EQUIPMENT NARRATIVE				
SUPPORT EQUIPMENT NARRATIVE CODE	K	414	SENARCEE	
FUNCTIONAL ANALYSIS		147		
DESCRIPTION AND FUNCTION OF SUPPORT EQUIPMENT		078		
SUPPORT EQUIPMENT NON-PROLIFERATION EFFORT		415		
CHARACTERISTICS OF SUPPORT EQUIPMENT		044		
INSTALATION FACTORS OR OTHER FACILITIES		169		
ADDITIONAL SKILLS AND SPECIAL TRAINING REQUIREMENTS		008		
SUPPORT EQUIPMENT EXPLANATION		411		
JUSTIFICATION		188		
Table EF, SUPPORT EQUIPMENT RECOMMENDATION DATA				
SUPPORT EQUIPMENT RECOMMENDATION DATA (SERD) NUMBER	K	416	SERDNOEF	
SERD REVISION	K	360	SRDREVEF	
SERD STATUS		404	STATUSEF	
SERD DATE OF INITIAL SUBMISSION		071	INTSUBEA	
SERD DATE OF GOVERNMENT DISPOSITION	G	071	DTGVDSEF	
SERD DATE OF REVISION SUBMISSION		071	DTRVSBEF	

Figure 71. Example of DD-Form 1949-3

MIL-STD-1388-2B

Part I	LSAR DATA REQUIREMENTS FORM			Section 2
DATA ELEMENT TITLE	KEY	DED	CODE	REQUIRED
Table EG, SERD REVISION REMARKS				
SERD REVISION REMARKS		417	REVREMEG	
Table EH, ALTERNATE NATIONAL STOCK NUMBERS				
ALTERNATE NATIONAL STOCK NUMBER	K	253	-----	
Table EI, INPUT POWER SOURCE				
INPUT POWER SOURCE	K	168	-----	
Table EJ, SUPPORT EQUIPMENT DESIGN DATA				
DESIGN DATA CATEGORY CODE (DDCC)	K	079	DSNDATEJ	
DDCC CONTRACTOR RECOMMENDED		057	CNTRECEJ	
DDCC ESTIMATED PRICE		101	ESTPRCEJ	
DDCC GOVERNMENT REQUIRED		150	GOVRQDEJ	
DDCC SCOPE		365	DDCCSCEJ	
Table EK, SUPERCEDURE DATA				
SUPERCEDURE CAGE CODE	K	046	SPRCAGEK	
SUPERCEDURE REFERENCE NUMBER	K	337	SPREFEK	
SUPERCEDURE TYPE	M	408	SUTYPEEK	
SUPERCEDURE ITEM NAME		182	SUPITNEK	
SUPERCEDURE SERD NUMBER		416	SUSRNOEK	
REASON FOR SUPERCEDURE/DELETION		327	REASUPEK	
SUPERCEDURE INTERCHANGEABILITY CODE		172	ICCODEEK	
Table EL, SUPPORT EQUIPMENT ILS REQUIREMENT CATEGORY CODE				
ILS REQUIREMENT CATEGORY CODE (IRCC)	K	171	IRCCODEL	
IRCC CONTRACTOR RECOMMENDED		057	CONRECEL	
IRCC ESTIMATED PRICE		101	ESTPRCEL	
IRCC GOVERNMENT REQUIRED		150	GOVRQDEL	
IRCC SCOPE		365	IRCSOCEL	
Table EM, SYSTEM EQUIPMENT				
SYSTEM CAGE CODE	F	046	SCAGECEM	
SYSTEM REFERENCE NUMBER	F	337	SREFNOEM	
SYSTEM EQUIPMENT QUANTITY PER TEST		320	QTYTSTEM	
SYSTEM EQUIPMENT ITEM DESIGNATOR		179	GFAEIDEM	
UNIT UNDER TEST REQUIREMENTS AND DESCRIPTION				
Table UA, ARTICLE REQUIRING SUPPORT/UNIT UNDER TEST (UUT)				
END ITEM ACRONYM CODE	F	096	EIACODXA	
UUT LSA CONTROL NUMBER (LCN)	F	199	UUTLCNUA	
UUT ALTERNATE LCN CODE	F	019	UUTALCUA	
UUT LCN TYPE	F	203	UTLCNTUA	
UUT ALLOWANCE		016	UTALLOUA	
UUT MAINTENANCE PLAN NUMBER	G	209	UMNTPLUA	
UUT TEST REQUIREMENTS DOCUMENT NUMBER		448	UTTRDNUA	
UUT WORK PACKAGE REFERENCE		515	UTWPRFUA	

Figure 71. Example of DD-Form 1949-3

MIL-STD-1388-2B

Part I	LSAR DATA REQUIREMENTS FORM			Section 2
DATA ELEMENT TITLE	KEY	DED	CODE	REQUIRED
Table UB, ARTICLE REQUIRING SUPPORT/UUT SUPPORT EQUIPMENT				
SUPPORT EQUIPMENT CAGE CODE	F	046	SECAGEEA	
SUPPORT EQUIPMENT REFERENCE NUMBER	F	337	SEREFNEA	
UUT CMRS SUMMARY STATUS		036	UTSTCDUB	
UUT CMRS RECOMMENDED CODE		035	UTCMRSUB	
Table UC, OPERATIONAL TEST PROGRAM				
OPERATIONAL TEST PROGRAM (OTP) CAGE CODE	F	046	OTPCAGUC	
OTP REFERENCE NUMBER	F	337	OTPREFUC	
OTP APPORTIONED UNIT COST		025	-----	
OTP COORDINATED TEST PLAN		060	OTPCTPUC	
OTP STANDARDS FOR COMPARISON		412	OTPSFCUC	
OTP SUPPORT EQUIPMENT RECOMMENDATION DATA NUMBER		416	OTPSRDUC	
Table UD, UUT SUPPORT EQUIPMENT OPERATIONAL TEST PROGRAM				
Table UE, TEST PROGRAM INSTRUCTION				
TEST PROGRAM INSTRUCTION (TPI) CAGE CODE	F	046	TPICAGUE	
TPI REFERENCE NUMBER	F	337	TPIREFUE	
TPI APPORTIONED UNIT COST		025	-----	
TPI SELF TEST		370	TPISTSUE	
TPI TECHNICAL DATA PACKAGE		434	TPITDPUE	
TPI SUPPORT EQUIPMENT RECOMMENDATION DATA NUMBER		416	TPISRDUUE	
Table UF, UNIT UNDER TEST EXPLANATION				
UUT EXPLANATION		498	UTEXPLUF	
Table UG, UNIT UNDER TEST PARAMETER GROUP				
UUT PARAMETERS	K	284	-----	
UUT CMRS PARAMETER CODE		034	UUTPPCUG	
UUT PARAMETER TEST ACCURACY RATIO		442	-----	
Table UH, UUT FAULT ISOLATED REPLACEABLE UNIT				
TASK LSA CONTROL NUMBER (LCN)	F	199	TSKLCNCI	
TASK ALTERNATE LCN CODE (ALC)	F	019	TSKALCCI	
TASK LCN TYPE	F	203	TSKLTYCI	
TASK PROVISION TASK CODE	F	427	TSKTCDCI	
TASK PROVISION LCN	F	199	PROLCNCI	
TASK PROVISION ALC	F	019	PROALCCI	
TASK PROVISION LCN TYPE	F	203	PROLTYCI	
TASK PROVISION CAGE CODE	F	046	PROCAGCI	
TASK PROVISION REFERENCE NUMBER	F	337	PROREFCI	
SUPPORT EQUIPMENT CAGE CODE	M	046	SECAGEEA	
SUPPORT EQUIPMENT REFERENCE NUMBER	M	337	SEREFNEA	
UUT FIRU FAULT ISOLATION		143	-----	
UUT FIRU TEST REQUIREMENTS DOCUMENT INDICATOR		447	UUTFTDUH	
Table UI, ADAPTER-INTERCONNECTOR DEVICE				
ADAPTER INTERCONNECTOR DEVICE (AID) CAGE CODE	F	046	AIDCAGUI	
AID REFERENCE NUMBER	F	337	AIDREFUI	
AID APPORTIONED UNIT COST		025	-----	

Figure 71. Example of DD-Form 1949-3

MIL-STD-1388-2B

Part I	LSAR DATA REQUIREMENTS FORM			Section 2
DATA ELEMENT TITLE	KEY	DED	CODE	REQUIRED
AID SUPPORT EQUIPMENT RECOMMENDATION DATA NUMBER		416	AIDSRDUI	
AID COMMON UNIT UNDER TEST		048	AIDCUTUI	
Table UJ, UUT SUPPORT EQUIPMENT ADAPTER-INTERCONNECTOR DEVICE				
Table UK, AUTOMATIC TEST EQUIPMENT TEST STATION				
ATE CAGE CODE	F	046	ATECAGUK	
AUTOMATIC TEST EQUIPMENT (ATE) REFERENCE NUMBER	F	337	ATEREFUK	
ATE GOVERNMENT DESIGNATOR		149	ATEGDSUK	
Table UL, UUT SUPPORT EQUIPMENT AUTOMATIC TEST EQUIPMENT				
Table UM, SUPPORT EQUIPMENT ITEM UNIT UNDER TEST				
SUPPORT EQUIPMENT UNIT UNDER TEST (SE UUT) CAGE CODE	F	046	SUTCAGUM	
SE UUT REFERENCE NUMBER	F	337	SUTREFUM	
SE UUT ALLOWANCE		016	SUTALLUM	
SE UUT CMRS STATUS		036	SUTSTCUM	
SE UUT MAINTENANCE PLAN NUMBER		209	MNTPLNUM	
SE UUT TEST REQUIREMENTS DOCUMENT NUMBER		448	TRDNUMUM	
SE UUT WORK PACKAGE REFERENCE		515	WPKRFUM	
Table UN, SUPPORT EQUIPMENT UUT PARAMETER GROUP				
SE UUT PARAMETERS	K	284	-----	
SE UUT CMRS PARAMETER CODE		034	UTPACMUN	
SE UUT PARAMETER TEST ACCURACY RATIO		442	-----	
FACILITIES CONSIDERATION				
Table FA, FACILITY				
FACILITY NAME	K	118	FACNAMFA	
FACILITY CATEGORY CODE	K	115	FACCFDFA	
FACILITY TYPE	K	483	TYPFACFA	
FACILITY CLASS		116	FACCLAFFA	
FACILITY DRAWING CLASSIFICATION		088	DRCLASFA	
FACILITY DRAWING NUMBER		089	FADNUMFA	
FACILITY DRAWING REVISION		360	FADREVFA	
FACILITY AREA		112	FAAREAFFA	
FACILITY AREA UNIT OF MEASURE		491	FAARUMFA	
FACILITY CONSTRUCTION UNIT OF MEASURE PRICE		492	FACNCOFA	
CONSTRUCTION UNIT OF MEASURE		491	CONUOMFA	
Table FB, FACILITY NARRATIVE				
FACILITY NARRATIVE CODE	K	119	FNCODEF	
FACILITY CAPABILITY		114		
FACILITY LOCATION		117		
Table FC, FACILITY BASELINE NARRATIVE				
BASELINE FACILITY NARRATIVE CODE	K	113	FBNACDFC	
FACILITIES MAINTENANCE REQUIREMENT		107		
FACILITIES REQUIREMENTS FOR OPERATIONS		109		
FACILITIES REQUIREMENT FOR TRAINING		110		

Figure 71. Example of DD-Form 1949-3

MIL-STD-1388-2B

Part I	LSAR DATA REQUIREMENTS FORM			Section 2
DATA ELEMENT TITLE	KEY	DED	CODE	REQUIRED
FACILITY REQUIREMENTS SPECIAL CONSIDERATIONS		120		
FACILITY REQUIREMENTS SUPPLY/STORAGE		121		
Table FD, NEW OR MODIFIED FACILITY NARRATIVE				
NEW OR MODIFIED FACILITY NARRATIVE CODE	K	255	NMFNCDFD	
FACILITY DESIGN CRITERIA		105		
FACILITY INSTALLATION LEAD TIME		106		
FACILITY TASK AREA BREAKDOWN		122		
FACILITIES UTILIZATION		111		
FACILITIES REQUIREMENTS		108		
FACILITY UNIT COST RATIONALE		123		
FACILITY JUSTIFICATION		188		
TYPE OF CONSTRUCTION		482		
UTILITIES REQUIREMENT		502		
Table FE, OPERATIONS AND MAINTENANCE TASK FACILITY REQUIREMENT				
END ITEM ACRONYM CODE	F	096	EIACODXA	
LSA CONTROL NUMBER (LCN)	F	199	LCNCODXA	
ALTERNATE LCN CODE	F	019	ALTLCNXB	
LCN TYPE	F	203	LCNTYPXB	
TASK CODE	F	427	TASKCDCA	
PERSONNEL SKILL CONSIDERATIONS				
Table GA, SKILL SPECIALTY				
SKILL SPECIALTY CODE	K	387	SKSPCDGA	
SKILL LEVEL CODE		386	SKLVCDGA	
HOUR LABOR RATE		161	HRLARTGA	
TRAINING COST		460	TRNCOSGA	
Table GB, NEW OR MODIFIED SKILL				
NEW OR MODIFIED SKILL SPECIALTY CODE	K	257	MDCSSCGB	
NEW OR MODIFIED SKILL LEVEL CODE		386	MDSCLCGB	
SKILL SPECIALTY CODE		387	SKSPCDGA	
DUTY POSITION REQUIRING A NEW OR REVISED SKILL		092	DPRNRSGB	
RECOMMENDED RANK/RATE/PAY PLAN/GRADE		330	-----	
SECURITY CLEARANCE		369	SCRSSCGB	
TEST SCORE		449	SSCTESGB	
ASVAB AFQT SCORE		026	ABAFQTGB	
ASVAB AFQT EXPECTED RANGE		026	-----	
ASVAB AFQT LOWEST PERCENT		026	-----	
Table GC, NEW OR MODIFIED SKILL NARRATIVE				
NEW OR MODIFIED SKILL NARRATIVE CODE	K	256	NMSNCDGC	
ADDITIONAL REQUIREMENTS		007		
EDUCATIONAL QUALIFICATIONS		094		
SKILL JUSTIFICATION		188		
ADDITIONAL TRAINING REQUIREMENTS		012		
Table GD, SKILL APTITUDE DATA				
ASVAB APTITUDE ELEMENT	K	026	ASVAPEGD	

Figure 71. Example of DD-Form 1949-3

MIL-STD-1388-2B

Part I	LSAR DATA REQUIREMENTS FORM			Section 2
DATA ELEMENT TITLE	KEY	DED	CODE	REQUIRED
ASVAB APTITUDE ELEMENT EXPECTED RANGE		026	-----	
ASVAB APTITUDE ELEMENT LOWEST PERCENT		026	-----	
Table GE, PHYSICAL AND MENTAL REQUIREMENTS NARRATIVE				
END ITEM ACRONYM CODE	F	096	EIACODXA	
LSA CONTROL NUMBER (LCN)	F	199	LSACONXB	
ALTERNATE LCN CODE	F	019	ALTLCNXB	
LCN TYPE	F	203	LCNTYPXB	
TASK CODE	F	427	TASKCDCA	
SUBTASK NUMBER	F	407	SUBNUMCB	
SUBTASK PERSON IDENTIFIER	F	288	SUBPIDCD	
PHYSICAL AND MENTAL REQUIREMENTS NARRATIVE		290	PAMENRGE	
TRANSPORTABILITY ENGINEERING ANALYSIS				
Table JA, TRANSPORTATION				
END ITEM ACRONYM CODE	F	096	EIACODXA	
LSA CONTROL NUMBER (LCN)	F	199	LSACONXB	
ALTERNATE LCN CODE	F	019	ALTLCNXB	
LCN TYPE	F	203	LCNTYPXB	
TRANSPORTATION INDICATOR		468	TRNINDJA	
SECTIONALIZED IDENTIFICATION		366	SECTIDJA	
ENVIRONMENTAL HANDLING AND TRANSPORTATION INDICATOR		098	ENHATCJA	
DELIVERY SCHEDULE		075	DELSCHJA	
CONTRACT NUMBER		055	CONNUMJA	
PROPER SHIPPING NAME		304	PROPSNJA	
SPEED		400	SPSPEDJA	
TOWING SPEED		455	TWSPEDJA	
MILITARY UNIT TYPE		242	MILUNTJA	
REVISION DATE		071	TRCHRDJA	
THEATER OF OPERATION		451	TRCHTHJA	
NONOPERATIONAL FRAGILITY FACTOR		260	NOPRFFJA	
NET EXPLOSIVE WEIGHT		254	NETEXWJA	
Table JB, TRANSPORTATION SHIPPING MODE				
TRANSPORTATION CHARACTER NUMBER	K	465	TRANCNJB	
TRANSPORTATION CHARACTER MODE TYPE	K	464	TRCHMTJB	
TRANSPORTATION ITEM DESIGNATOR		469	TRITDRJB	
SHIPPING CONFIGURATION		380	SHPCONJB	
CONTAINER LENGTH		053	CONLENJB	
CONTAINER TYPE		054	CONTYPJB	
FREIGHT CLASSIFICATION		146	FRCLASJB	
EXTERNAL OR INTERNAL LOAD INDICATOR		104	EOILINJB	
HELICOPTER MISSION		159	-----	
HIGHWAY MODEL LOAD		250	-----	
HIGHWAY MODEL TYPE		251	-----	
RAIL USE		326	RAILUSJB	
RAIL TRANSPORTATION COUNTRY		325	RAILTCJB	
SEA DECK STOWAGE		072	SDECKSJB	
Table JC, TRANSPORTED END ITEM				
TRANSPORTED CONFIGURATION NUMBER	K	473	TRCONMJC	
MOBILITY TYPE	K	249	MOBTYPJC	

Figure 71. Example of DD-Form 1949-3

MIL-STD-1388-2B

Part I	LSAR DATA REQUIREMENTS FORM				Section 2
DATA ELEMENT TITLE	KEY	DED	CODE		REQUIRED
OPERATIONAL WEIGHT EMPTY/LOADED		276	-----		
MILITARY LOAD CLASSIFICATION EMPTY/LOADED		241	-----		
SHIPPING WEIGHT EMPTY/LOADED		381	-----		
CREST ANGLE		063	CREANGJC		
TRACKED GROUND PRESSURE		456	TRGRPRJC		
TRACKED ROAD WHEEL WEIGHT		459	TRRWWTJC		
TRACKED PADS TOUCHING		458	TRNUPTJC		
TRACKED PAD SHOE AREA		457	TRPSARJC		
WHEELED INFLATION PRESSURE		507	WHINPRJC		
WHEELED NUMBER OF PLYS		508	WHNUPLJC		
WHEELED NUMBER TIRES		509	WHNUTIJC		
WHEELED TIRE LOAD RATINGS		510	WHTLDRJC		
WHEELED TIRE SIZE		512	WHTIFTJC		
WHEELED WEIGHT RATINGS		513	WHWERAJC		
AXLE LENGTH		029	-----		
SKID NUMBER OF SKIDS		264	SNUMSKJC		
SKID AREA		384	SDSICGJC		
Table JD, TRANSPORTED END ITEM NARRATIVE					
TRANSPORTED END ITEM NARRATIVE CODE	K	474	TREINCJD		
WHEELED TIRE REQUIREMENTS		511			
SKID REMARKS		385			
TURNING INFORMATION		477			
WHEELED AXLE AND SUSPENSION REMARKS		506			
TRANSPORTED OTHER EQUIPMENT		475			
Table JE, TRANSPORT BY FISCAL YEAR					
TRANSPORT FISCAL YEAR	K	145	TRAFYRJE		
FIRST QUARTER PROCUREMENT QUANTITY		298	FIQPQTJE		
SECOND QUARTER PROCUREMENT QUANTITY		298	SQPQTYJE		
THIRD QUARTER PROCUREMENT QUANTITY		298	TQPQTYJE		
FOURTH QUARTER PROCUREMENT QUANTITY		298	FQPQTYJE		
Table JF, TRANSPORTATION NARRATIVE					
TRANSPORTATION NARRATIVE CODE	K	470	TRANCDJF		
TRANSPORTATION SHOCK VIBRATION REMARKS		382			
LIFTING AND TIEDOWN REMARKS		192			
TRANSPORTATION PROJECTION REMARKS		471			
REGULATORY REQUIREMENTS		340			
TRANSPORTATION REMARKS		472			
SPECIAL SERVICE AND EQUIPMENT		398			
SECTIONALIZED REMARKS		368			
TRANSPORTED TO AND FROM		476			
ENVIRONMENTAL CONSIDERATIONS		099			
MILITARY DISTANCE CLASSIFICATION		240			
UNUSUAL AND SPECIAL REQUIREMENTS		500			
VENTING AND PROTECTIVE CLOTHING		504			
DISASTER RESPONSE FORCE REQUIREMENTS		082			

Figure 71. Example of DD-Form 1949-3

MIL-STD-1388-2B

Part II LSAR DATA REQUIREMENTS FORM Section 2																			
PROVISIONING REQUIREMENTS																			
DATA ELEMENT TITLE	KEY	DED	CODE	LSA 036 CARD BLOCK	R E Q U I R E D	L E T T E R	P L A C E	S E P A R A T E	C O N T A I N S	R E F E R E N C E	I N T E R F A C E	P R O C E S S I N G	T E M P O R A R Y	S T R U C T U R E	D E S I G N	A P P L I C A T I O N	A R E A	A R B I T R A R Y	
CROSS FUNCTIONAL REQUIREMENT																			
Table XC, SYSTEM/END ITEM (SEE ALSO PART I)																			
USABLE ON CODE	G	501	UOCSEIXC	D-43															
SYSTEM/EI PCCN	G	307	PCCNUMXC	A-1															
SYSTEM/EI PLISN		309	PLISNOXC	A-2															
SYSTEM/EI TYPE OF CHANGE CODE		481	TOCCODXC	A-3															
SYSTEM/EI QUANTITY PER ASSEMBLY		316	QTYASYXC	C-32															
SYSTEM/EI QUANTITY PER END ITEM		317	QTYPEIXC	C-33															
Table XD, SYSTEM/END ITEM SERIAL NUMBER (SEE ALSO PART I)																			
PACKAGING AND PROVISIONING REQUIREMENT																			
Table HA, ITEM IDENTIFICATION (SEE ALSO PART III)																			
CAGE CODE	F	046	CAGECDXH	A-5															
REFERENCE NUMBER	K	337	REFNUMHA	A-6															
ITEM NAME		182	ITNAMEHA	A-12															
ITEM NAME CODE		183	INAMECHA	J-89															
REFERENCE NUMBER CATEGORY CODE		338	REFNCCHA	A-7															
REFERENCE NUMBER VARIATION CODE		339	REFNVCHA	A-8															
DLSC SCREENING REQUIREMENT CODE		073	DLSCRCHA																
DOCUMENT IDENTIFIER CODE		087	DOCIDCHA																
ITEM MANAGEMENT CODE		181	ITMMGCHA	E-64															
NSN PREFIX		253	-----	B-15															
NATIONAL STOCK NUMBER (NSN)		253	-----	B-15															
NSN SUFFIX		253	-----	B-15															
UNIT OF ISSUE CONVERSION FACTOR		489	UICONVHA	B-20															
SHELF LIFE		377	SHLIFEHA	A-13															
SHELF LIFE ACTION CODE		378	SLACTNHA	A-14															
PROGRAM PARTS SELECTION LIST		302	PPSLSTHA	A-10															
DOCUMENT AVAILABILITY CODE		086	DOCAVCHA	A-9															
PRODUCTION LEAD TIME		299	PRDLDTHA	B-24															
SPECIAL MATERIAL CONTENT CODE		395	SPMACCHA	D-47															
SPECIAL MAINTENANCE ITEM CODE		392	SMAINCHA	D-49															
CRITICALITY CODE		066	CRITCDHA	J-88															
PRECIOUS METAL INDICATOR CODE		293	PMICODHA	B-27															
SPARES ACQ INTEGRATED WITH PRODUCTION		391	SAIPCDHA																
PROVISIONING LIST CATEGORY CODE		308	-----	D-48															
PHYSICAL SECURITY PILFERAGE CODE		291	PHYSECHA	B-26															
ADP EQUIPMENT CODE		027	ADPEQPHA	B-28															
DEMILITARIZATION CODE		076	DEMILIHA	B-23															
ACQUISITION METHOD CODE	G	003	ACQMETHA	E-62															
ACQUISITION METHOD SUFFIX CODE	G	004	AMSUFCHA	E-63															
HAZARDOUS MATERIALS STORAGE COST		156	HMSCOSHA																
HAZARDOUS WASTE DISPOSAL COST		157	HWDCOSHA																
HAZARDOUS WASTE STORAGE COST		158	HWSCOSHA																
CONTRACTOR TECHNICAL INFORMATION CODE		058	CTICODHA	E-61															
UNIT OF MEASURE		491	UNITMSHA	B-16															
UNIT OF ISSUE		488	UNITISHA	B-18															

Figure 71. Example of DD-Form 1949-3

MIL-STD-1388-2B

Part II LSAR DATA REQUIREMENTS FORM Section 2																				
PROVISIONING REQUIREMENTS																				
DATA ELEMENT TITLE	KEY	DED	CODE	LSA 036 CARD BLOCK	R E Q U I R E D	L E T T E R	P L A N E T	S P A C E	C B I L I T Y	R I L I T Y	I S I L A T E D	P C L E S S E D	T E L E P H O N E	S C P L E N E T	D C N A R Y	A R A R Y	A R B I T R A R Y			
LINE ITEM NUMBER		193	LINNUMHA																	
CRITICAL ITEM CODE		065	CRITITHA																	
INDUST MATERIALS ANALYSIS OF CAPACIT	Y	163	INDMATHA																	
MATERIAL LEADTIME		219	MTLEADHA																	
MATERIAL WEIGHT		220	MTLWGTHA																	
MATERIAL		218	MATERLHA	M-92																
Table HB, ADDITIONAL REFERENCE NUMBER																				
ARN CAGE CODE	F	046	ADCAGEHB	A-5																
ADDITIONAL REFERENCE NUMBER	K	006	ADDRFHB	A-6																
ARN REFERENCE NUMBER CATEGORY CODE		338	ADRNCCHB	A-7																
ARN REFERENCE NUMBER VARIATION CODE		339	ADRNVCHB	A-8																
Table HC, CONTRACTOR TECHNICAL IFORMATION CODE CAGE																				
CTIC CAGE CODE	F	046	CTCAGEHC																	
Table HD, UNIT OF ISSUE PRICE																				
UNIT OF ISSUE (UI) PRICE	K	490	UIPRICHD	B-19																
UI PRICE LOT QUANTITY		205	-----																	
UI PRICE CONCURRENT PRODUCTION CODE		051	CURPRCHD																	
UI PRICE TYPE OF PRICE CODE		485	TUIPRCHD																	
UI PRICE PROVISIONING		314	PROUIPHD																	
UI PRICE FISCAL YEAR		145	FISCYRHD																	
Table HE, UNIT OF MEASURE PRICE																				
UNIT OF MEASURE (UM) PRICE	K	492	UMPRICHE	B-17																
UM PRICE LOT QUANTITY		205	-----																	
UM PRICE CONCURRENT PRODUCTION CODE		051	CURPRCHE																	
UM PRICE TYPE OF PRICE CODE		485	TUMPRCHE																	
UM PRICE PROVISIONING		314	PROUMPHE																	
UM PRICE FISCAL YEAR		145	FISCYRHE																	
Table HG, PART APPLICATION PROVISIONING																				
END ITEM ACRONYM CODE	F	096	EIACODXA																	
LSA CONTROL NUMBER (LCN)	F	199	LSACONXB	H-77																
ALTERNATE LCN CODE	F	019	ALTLCNXB	H-78																
LCN TYPE	F	203	LCNTYPXB																	
PROV LIST ITEM SEQUENCE NO (PLISN)		309	PLISNOHG	A-2																
QUANTITY PER ASSEMBLY		316	QTYASYHG	C-32																
OPTION 1																				
OPTION 2	N																			
OPTION 3																				
SUPPRESSION INDICATOR		422	SUPINDHG																	
DATA STATUS CODE		070	DATASCHG																	
PROVISIONING SYSTEM IDENTIFIER CODE	C	312	PROSICHG																	
PTD SELECTION CODE		313	-----																	
TYPE OF CHANGE CODE		481	TOCCODHG	A-3																
INDENTURE CODE		162	INDCODHG	A-4																

Figure 71. Example of DD-Form 1949-3

MIL-STD-1388-2B

Part II LSAR DATA REQUIREMENTS FORM Section 2																			
PROVISIONING REQUIREMENTS																			
DATA ELEMENT TITLE	KEY	DED	CODE	LSA 036 CARD BLOCK	R E Q U I R E D	L E L E M E N T	P L A C E	S P A C E	C O N T A I N E R	R E L E V A N C E	I N T E R F A C E	P R O C E D U R E	T E S T I N G	S U P P L Y	D I S T R I B U T I O N	A R R A N G E M E N T	A R R A N G E M E N T		
ATTACHING PART/HARDWARE																			
OPTION 1																			
OPTION 2																			
OPTION 3																			
OPTION 4																			
OPTION 5																			
INDENTURE FOR KITS																			
OPTION 1																			
OPTION 2																			
OPTION 3																			
QUANTITY PER END ITEM		317	QTYPEIHG	C-33															
OPTION 1																			
OPTION 2	N																		
OPTION 3	C																		
PRIOR ITEM PLISN		297	PIPLISHG	C-39															
SAME AS PLISN		364	SAPLISHG	C-38															
HARDNESS CRITICAL ITEM		151	HARDCIHG	B-25															
REMAIN IN PLACE INDICATOR		348	REMIPIHG	E-65															
LINE REPLACEABLE UNIT		194	LRUNITHG	J-90															
ITEM CATEGORY CODE		177	ITMCATHG																
ESSENTIALITY CODE		100	ESSCODHG	A-11															
SOURCE, MAINT AND RECOVERABILTY CODE		389	SMRCODHG	B-22															
MAINTENANCE REPLACEMENT RATE I		211	MRRONEHG	C-34															
MAINTENANCE REPLACEMENT RATE II		212	MRRTWOHG	C-35															
OPTION 1																			
OPTION 2																			
MAINTENANCE REPLACEMENT RATE MODIFIER	A	213	MRRMODHG	C-36															
REPLACEMENT TASK DISTRIBUTION		355	-----	E-59															
MINIMUM REPLACEMENT UNIT		245	MINREUHG	D-52															
MAXIMUM ALLOWABLE OPERATING TIME		221	MAOTIMHG	C-40															
MAINTENANCE ACTION CODE		206	MAIACTHG	C-41															
RECOMMENDED INITIAL SYSTEM STOCK BUY		328	RISSBUHG	D-54															
RECOMMENDED MINIMUM SYSTEM STOCK LEVEL		329	RMSSLIHG	D-53															
RECOMMENDED TENDER LOAD LIST QUANTITY	N	331	RTLLQTHG	D-55															
TOTAL QUANTITY RECOMMENDED		453	TOTQTYHG	C-37															
MAINTENANCE TASK DISTRIBUTION		214	-----	E-57															
REPAIR CYCLE TIME		350	-----	E-58															
OPTION 1																			
OPTION 2																			
NOT REPAIRABLE THIS STATION	R	261	NORETSHG	C-42															
REPAIR SURVIVAL RATE		351	REPSURHG	D-56															
DESIGNATED REWORK POINT		081	-----	E-60															
WORK UNIT CODE		516	WRKUCDHG	J-86															
ALLOWANCE ITEM CODE		017	ALLOWCHG	D-50															
ALLOWANCE ITEM QUANTITY		018	ALIQTYHG	D-51															
Table HH, OVERHAUL-KIT NEXT HIGHER ASSEMBLY PLISN																			
NEXT HIGHER ASSEMBLY (NHA) PLISN	K	258	NHAPLIHG	C-29															
NHA PLISN INDICATOR		259	NHAINDHG	C-30															
OVERHAUL REPLACEMENT RATE		281	OVHREPHG	C-31															

Figure 71. Example of DD-Form 1949-3

MIL-STD-1388-2B

Part II LSAR DATA REQUIREMENTS FORM Section 2																		
PROVISIONING REQUIREMENTS																		
DATA ELEMENT TITLE	KEY	DED	CODE	LSA 036 CARD BLOCK	R E Q U I R E D	L E T T E R S	P L A C E H O L D E R S	S P E C I F I C A T I O N S	C O M P L E X I T Y	R E P E T I T I V E	I N T E R F A C E	P R O C E D U R E	T E C H N I C A L	S T R U C T U R E	D I S T R I B U T I O N	A V A I L A B I L I T Y	A R R A N G E M E N T	A R R A N G E M E N T
Table HI, PROVISIONING REMARK																		
PROVISIONING REMARKS		311	REMARKHI	H-79														
Table HJ, PROVISIONING REFERENCE DESIGNATION																		
REFERENCE DESIGNATION	K	335	REFDESHJ	D-44														
OPTION 1																		
OPTION 2																		
OPTION 3																		
OPTION 4																		
OPTION 5																		
REFERENCE DESIGNATION CODE	K	336	RDCODEHJ	D-46														
TECHNICAL MANUAL (TM) CODE		437	TMCODEXI															
FIGURE NUMBER		144	FIGNUMHK															
ITEM NUMBER		184	ITEMNOHK															
Table HK, PARTS MANUAL DESCRIPTION																		
TECHNICAL MANUAL (TM) CODE	F	437	TMCODEXI	J-80														
FIGURE NUMBER	K	144	FIGNUMHK	J-81														
ITEM NUMBER	K	184	ITEMNOHK	J-82														
TM FUNCTIONAL GROUP CODE		438	TMFGCDHK	J-86														
TM INDENTURE CODE		439	TMINDCHK	J-84														
QUANTITY PER FIGURE		318	QTYFIGHK	J-85														
TM CHANGE NUMBER		436	TMCHGNHK	J-83														
Table HL, PARTS MANUAL PROVISIONING NOMENCLATURE																		
PROVISIONING NOMENCLATURE		310	PROVNOHL	K-91														
Table HM, BASIS OF ISSUE																		
BASIS OF ISSUE	K	030	-----	J-87														
Table HN, PROVISIONING SERIAL NUMBER USABLE ON CODE																		
S/N PROVISIONING SYSTEM/EI LCN	F	199	LCNSEIHN															
S/N PROVISIONING SYSTEM/EI ALC	F	019	ALCSEIHN															
S/N PROVISIONING SERIAL NUMBER	F	373	-----															
Table HO, PROVISIONING SYSTEM/END ITEM USABLE ON CODE																		
UOC PROVISIONING SYSTEM/EI LCN	F	199	LCNSEIHO															
UOC PROVISIONING SYSTEM/EI ALC	F	019	ALCSEIHO															
Table HP, DESIGN CHANGE INFORMATION																		
CHANGE AUTHORITY NUMBER	K	043	CANUMBHP	F-66														
REPLACED OR SUPERSEDING (R/S) PLISN		353	RSPLISHP	F-70														
R/S PLISN INDICATOR		354	RSPINDHP	F-71														
INTERCHANGEABILITY CODE		172	INTCHHP	F-67														
TOTAL ITEM CHANGES		452	TOTICHHP	F-69														
OPTION 1																		
OPTION 2																		

Figure 71. Example of DD-Form 1949-3

MIL-STD-1388-2B

Part II LSAR DATA REQUIREMENTS FORM Section 2																		
PROVISIONING REQUIREMENTS																		
DATA ELEMENT TITLE	KEY	DED	CODE	LSA 036 CARD BLOCK	R E Q U I R E D	L I N E I T E M N U M B E R	P R O C E D U R E	S E R I A L N U M B E R	C O D E	R E L E A S E D	I N S T R U C T I O N S	P R O C E D U R E	T E M P O R A R Y	S T O R E D	D E L E T E D	A R C H I V E D	A R C H I V E D	A R C H I V E D
QUANTITY SHIPPED		323	QTYSHPHP	F-72														
QUANTITY PROCURED		322	QTYPROHP	F-73														
PRORATED EXHIBIT LINE ITEM NUMBER		305	PROELIHP	G-75														
PRORATED QUANTITY		306	PROQTYHP	G-76														
Table HQ, SERIAL NUMBER EFFECTIVITY																		
SERIAL NUMBER EFFECTIVITY	K	374	-----	F-68														
Table HR, DESIGN CHANGE USABLE ON CODE				F-74														

Figure 71. Example of DD-Form 1949-3

MIL-STD-1388-2B

Part III	LSAR DATA REQUI REMENT S FORM					Section 2	
DATA ELEMENT TITLE	KEY	DED	CODE	REQ'D	COMMON	SELECTIVE	SPECIAL
PACKAGING AND PROVISIONING REQUIREMENT							
Table HA, ITEM IDENTIFICATION (SEE ALSO PART II)							
UNIT WEIGHT		497	UWEIGHHA				
UNIT SIZE		496	-----				
HAZARDOUS CODE		154	HAZCODHA				
Table HF, Item Packaging Requirement							
CAGE CODE	F	046	CAGECDXH				
REFERENCE NUMBER	F	337	REFNUMHA				
DEGREE OF PROTECTION CODE	K	074	DEGPROHF				
UNIT CONTAINER CODE		486	UNICONHF				
UNIT CONTAINER LEVEL		487	UCLEVLHF				
PACKING CODE		283	PKGCODHF				
PACKAGING CATEGORY CODE		282	PACCATHF				
METHOD OF PRESERVATION CODE		239	MEPRESHF				
CLEANING AND DRYING PROCEDURES		045	CDPROCHF				
PRESERVATION MATERIAL CODE		295	PRSMATHF				
WRAPPING MATERIAL		517	WRAPMTHF				
CUSHIONING AND DUNNAGE MATERIAL		067	CUSHMAHF				
CUSHIONING THICKNESS		068	CUSTHIHF				
QUANTITY PER UNIT PACK		321	QTYUPKHF				
INTERMEDIATE CONTAINER CODE		174	INTCONHF				
INTERMEDIATE CONTAINER QUANTITY		175	INCQTYHF				
SPECIAL MARKING CODE		394	SPEMRKHF				
UNIT PACK WEIGHT		495	UNPKWTHF				
UNIT PACK SIZE		494	-----				
UNIT PACK CUBE		493	UNPKCUHF				
OPTIONAL PROCEDURES INDICATOR		279	OPTPRIHF				
SPECIAL PACKAGING INSTRUCTION (SPI)		396	SPINUMHF				
SPI NUMBER REVISION		397	SPIREVHF				
SPI NUMBER JULIAN DATE		187	SPDATEHF				
CONTAINER NATIONAL STOCK NUMBER		253	CONNSNHF				
SUPPLEMENTAL PACKAGING DATA		409	SUPPKDHF				
PACKAGING DATA PREPARER CAGE		046	PKCAGEHF				

Figure 71. Example of DD-Form 1949-3

THIS PAGE INTENTIONALLY LEFT BLANK

CONCLUDING MATERIAL

Custodians:

Army - TM
Navy - AS
Air Force - 95

Preparing Activity:

Army - TM

(Project No. ILSS-0003)

Review Activities:

Army - ME, MI, AV, AT, GR
Navy - SH, YD, OS, MC
Air Force - 11, 13, 15, 16, 17
Miscellaneous DOD/NASA - DH, NS, NA, DS, DC

THIS PAGE INTENTIONALLY LEFT BLANK

STANDARDIZATION DOCUMENT IMPROVEMENT PROPOSAL

(See Instructions - Reverse Side)

1. DOCUMENT NUMBER		2. DOCUMENT TITLE	
3a. NAME OF SUBMITTING ORGANIZATION		4. TYPE OF ORGANIZATION (Mark one)	
b. ADDRESS (Street, City, State, ZIP Code)		<input type="checkbox"/> VENDOR	
		<input type="checkbox"/> USER	
		<input type="checkbox"/> MANUFACTURER	
		<input type="checkbox"/> OTHER (Specify): _____	
5. PROBLEM AREAS			
a. Paragraph Number and Wording:			
b. Recommended Wording:			
c. Reason/Rationale for Recommendation:			
6. REMARKS			
7a. NAME OF SUBMITTER (Last, First, MI) - Optional		b. WORK TELEPHONE NUMBER (Include Area Code) - Optional	
c. MAILING ADDRESS (Street, City, State, ZIP Code) - Optional		8. DATE OF SUBMISSION (YYMMDD)	

DD FORM 1426
82 MAR

PREVIOUS EDITION IS OBSOLETE.

INSTRUCTIONS: In a continuing effort to make our standardization documents better, the DoD provides this form for use in submitting comments and suggestions for improvements. All users of military standardization documents are invited to provide suggestions. This form may be detached, folded along the lines indicated, taped along the loose edge (*DO NOT STAPLE*), and mailed. In block 5, be as specific as possible about particular problem areas such as wording which required interpretation, was too rigid, restrictive, loose, ambiguous, or was incompatible, and give proposed wording changes which would alleviate the problems. Enter in block 6 any remarks not related to a specific paragraph of the document. If block 7 is filled out, an acknowledgement will be mailed to you within 30 days to let you know that your comments were received and are being considered.

NOTE: This form may not be used to request copies of documents, nor to request waivers, deviations, or clarification of specification requirements on current contracts. Comments submitted on this form do not constitute or imply authorization to waive any portion of the referenced document(s) or to amend contractual requirements.

(Fold along this line)

(Fold along this line)

DEPARTMENT OF THE ARMY



NO POSTAGE
NECESSARY
IF MAILED
IN THE
UNITED STATES

OFFICIAL BUSINESS
PENALTY FOR PRIVATE USE \$300

BUSINESS REPLY MAIL
FIRST CLASS PERMIT NO. 12062 WASHINGTON D. C.
POSTAGE WILL BE PAID BY THE DEPARTMENT OF THE ARMY

